



Sun Fire™ Entry-Level Midrange System Administration Guide

Sun Microsystems, Inc.
www.sun.com

Part No. 817-5233-10
April 2004, Revision A

Submit comments about this document at: <http://www.sun.com/hwdocs/feedback>

Copyright 2004 Sun Microsystems, Inc., 4150 Network Circle, Santa Clara, California 95054, U.S.A. All rights reserved.

Sun Microsystems, Inc. has intellectual property rights relating to technology embodied in the product that is described in this document. In particular, and without limitation, these intellectual property rights may include one or more of the U.S. patents listed at <http://www.sun.com/patents> and one or more additional patents or pending patent applications in the U.S. and in other countries.

This document and the product to which it pertains are distributed under licenses restricting their use, copying, distribution, and decompilation. No part of the product or of this document may be reproduced in any form by any means without prior written authorization of Sun and its licensors, if any.

Third-party software, including font technology, is copyrighted and licensed from Sun suppliers.

Parts of the product may be derived from Berkeley BSD systems, licensed from the University of California. UNIX is a registered trademark in the U.S. and in other countries, exclusively licensed through X/Open Company, Ltd.

Sun, Sun Microsystems, the Sun logo, AnswerBook2, docs.sun.com, and Solaris are trademarks or registered trademarks of Sun Microsystems, Inc. in the U.S. and in other countries.

All SPARC trademarks are used under license and are trademarks or registered trademarks of SPARC International, Inc. in the U.S. and in other countries. Products bearing SPARC trademarks are based upon an architecture developed by Sun Microsystems, Inc.

The OPEN LOOK and Sun™ Graphical User Interface was developed by Sun Microsystems, Inc. for its users and licensees. Sun acknowledges the pioneering efforts of Xerox in researching and developing the concept of visual or graphical user interfaces for the computer industry. Sun holds a non-exclusive license from Xerox to the Xerox Graphical User Interface, which license also covers Sun's licensees who implement OPEN LOOK GUIs and otherwise comply with Sun's written license agreements.

U.S. Government Rights—Commercial use. Government users are subject to the Sun Microsystems, Inc. standard license agreement and applicable provisions of the FAR and its supplements.

DOCUMENTATION IS PROVIDED "AS IS" AND ALL EXPRESS OR IMPLIED CONDITIONS, REPRESENTATIONS AND WARRANTIES, INCLUDING ANY IMPLIED WARRANTY OF MERCHANTABILITY, FITNESS FOR A PARTICULAR PURPOSE OR NON-INFRINGEMENT, ARE DISCLAIMED, EXCEPT TO THE EXTENT THAT SUCH DISCLAIMERS ARE HELD TO BE LEGALLY INVALID.

Copyright 2004 Sun Microsystems, Inc., 4150 Network Circle, Santa Clara, California 95054, Etats-Unis. Tous droits réservés.

Sun Microsystems, Inc. a les droits de propriété intellectuelle relatants à la technologie incorporée dans le produit qui est décrit dans ce document. En particulier, et sans la limitation, ces droits de propriété intellectuelle peuvent inclure un ou plus des brevets américains énumérés à <http://www.sun.com/patents> et un ou les brevets plus supplémentaires ou les applications de brevet en attente dans les Etats-Unis et dans les autres pays.

Ce produit ou document est protégé par un copyright et distribué avec des licences qui en restreignent l'utilisation, la copie, la distribution, et la décompilation. Aucune partie de ce produit ou document ne peut être reproduite sous aucune forme, par quelque moyen que ce soit, sans l'autorisation préalable et écrite de Sun et de ses bailleurs de licence, s'il y en a.

Le logiciel détenu par des tiers, et qui comprend la technologie relative aux polices de caractères, est protégé par un copyright et licencié par des fournisseurs de Sun.

Des parties de ce produit pourront être dérivées des systèmes Berkeley BSD licenciés par l'Université de Californie. UNIX est une marque déposée aux Etats-Unis et dans d'autres pays et licenciée exclusivement par X/Open Company, Ltd.

Sun, Sun Microsystems, le logo Sun, AnswerBook2, docs.sun.com, et Solaris sont des marques de fabrique ou des marques déposées de Sun Microsystems, Inc. aux Etats-Unis et dans d'autres pays.

Toutes les marques SPARC sont utilisées sous licence et sont des marques de fabrique ou des marques déposées de SPARC International, Inc. aux Etats-Unis et dans d'autres pays. Les produits portant les marques SPARC sont basés sur une architecture développée par Sun Microsystems, Inc.

L'interface d'utilisation graphique OPEN LOOK et Sun™ a été développée par Sun Microsystems, Inc. pour ses utilisateurs et licenciés. Sun reconnaît les efforts de pionniers de Xerox pour la recherche et le développement du concept des interfaces d'utilisation visuelle ou graphique pour l'industrie de l'informatique. Sun détient une licence non exclusive de Xerox sur l'interface d'utilisation graphique Xerox, cette licence couvrant également les licenciées de Sun qui mettent en place l'interface d'utilisation graphique OPEN LOOK et qui en outre se conforment aux licences écrites de Sun.

LA DOCUMENTATION EST FOURNIE "EN L'ÉTAT" ET TOUTES AUTRES CONDITIONS, DECLARATIONS ET GARANTIES EXPRESSES OU TACITES SONT FORMELLEMENT EXCLUES, DANS LA MESURE AUTORISEE PAR LA LOI APPLICABLE, Y COMPRIS NOTAMMENT TOUTE GARANTIE IMPLICITE RELATIVE A LA QUALITE MARCHANDE, A L'APTITUDE A UNE UTILISATION PARTICULIERE OU A L'ABSENCE DE CONTREFAÇON.



Adobe PostScript

Contents

Preface xvii

1. Overview 1

System Controller 1

I/O Ports 2

LOM Prompt 3

Solaris Console 4

Environmental Monitoring 4

System Indicator Board 4

Reliability, Availability, and Serviceability (RAS) 6

Reliability 6

Disabling Components or Boards and Power-On Self-Test (POST) 7

Manual Disabling of Components 7

Environmental Monitoring 7

Availability 7

Dynamic Reconfiguration 8

Power Failure 8

System Controller Reboot 8

Host Watchdog 8

Serviceability 8

LEDs	9
Nomenclature	9
System Controller Error Logging	9
System Controller XIR (eXternally Initiated Reset) Support	9
2. Starting and Setting Up Sun Fire Entry-Level Midrange Systems	11
Installing and Cabling Hardware	12
Using the Power (On/Standby) Switch	13
Powering On and Off	14
Powering On	14
▼ Initial Power-On	14
▼ Powering On from Standby Mode	14
Bringing the System to Standby Mode	15
After Powering On	18
Setting Up the System	19
▼ To Set the Date and Time	19
▼ To Set Up the Password	20
▼ To Configure Network Parameters	20
Installing and Booting the Solaris Operating Environment	22
▼ To Install and Boot the Solaris Operating Environment	22
▼ To Install the Lights Out Management Packages	23
▼ To Install the LOM Drivers	23
▼ To Install the LOM Utility	25
▼ To Install the LOM Manual Pages	26
Resetting the System	26
▼ To Forcibly Reset the System	26
▼ To Reset the System Controller	27
3. Console Navigation Procedures	29

Establishing a LOM/Console Connection 30

Accessing the LOM/Console Using the Serial Port 30

- ▼ To Connect to an ASCII Terminal 30
- ▼ To Connect to a Network Terminal Server 32
- ▼ To Connect to Serial Port B of a Workstation 33
- ▼ To Access the LOM/Console Using the Telnet Command 35
- ▼ To Disconnect from the LOM/Console 36

Switching Between the Different Consoles 37

- ▼ To Break to the LOM Prompt 39
 - Selecting an Escape Sequence 39
- ▼ To Connect to the Solaris Console from the LOM Prompt 39
- ▼ To Break to the LOM Prompt from the OpenBoot PROM 40
- ▼ To Break to the OpenBoot Prompt when Solaris is Running 41
- ▼ To Terminate a Session If You Are Connected To the System Controller Through the Serial Port 41
- ▼ To Terminate a Session If You Are Connected to the System Controller with `telnet` 42

4. System Controller Message Logging 43

5. Using Lights Out Management and the System Controller from Solaris 45

LOM Command Syntax 45

Monitoring the System From Solaris 46

- Viewing Online LOM Documentation 46
- Viewing the LOM Configuration (`lom -c`) 47
- Checking the Status of the Fault LED and Alarms (`lom -l`) 47
- Viewing the Event Log (`lom -e`) 48
- Checking the Fans (`lom -f`) 49
- Checking the Internal Voltage Sensors (`lom -v`) 49
- Checking the Internal Temperature (`lom -t`) 52

Viewing All Component Status Data and the LOM Configuration Data (<code>lom -a</code>)	53
Other LOM Tasks Performed From Solaris	54
Turning Alarms On and Off (<code>lom -A</code>)	54
Changing the <code>lom></code> Prompt Escape Sequence (<code>lom -X</code>)	55
Stopping LOM from Sending Reports to the Console When at the LOM Prompt (<code>lom -E off</code>)	55
Upgrading the Firmware (<code>lom -G filename</code>)	56
6. Running POST	57
OpenBoot PROM Variables for POST Configuration	57
Controlling POST With the <code>bootmode</code> Command	61
Controlling the System Controller POST	62
7. Automatic Diagnosis and Recovery	65
Automatic Diagnosis and Recovery Overview	65
Automatic Recovery of a Hung System	67
Diagnosis Events	68
Diagnostic and Recovery Controls	69
Diagnostic Parameters	69
Obtaining Auto-Diagnosis and Recovery Information	70
Reviewing Auto-Diagnosis Event Messages	70
Reviewing Component Status	72
Reviewing Additional Error Information	74
8. Troubleshooting	75
Device Mapping	75
CPU/Memory Mapping	75
IB_SSC Assembly Mapping	76
System Faults	80

Customer Replaceable Units	81
Sun Fire E2900	81
Sun Fire V1280	82
Netra 1280	82
Manual Blacklisting (while waiting for repair)	82
Special Considerations for CPU/Memory Boards	84
Recovering a Hung System	85
▼ To Recover a Hung System Manually	85
Moving System Identity	87
Temperature	87
Power Supplies	90
Displaying Diagnostic Information	90
Assisting Sun Service Personnel in Determining Causes of Failure	91
9. Firmware Upgrade Procedures	93
Using the <code>flashupdate</code> Command	93
▼ To Upgrade a Sun Fire V1280 or Netra 1280 System Running Firmware Version 5.13.x to 5.17.0 Using the <code>flashupdate</code> Command	95
▼ To Downgrade the Firmware on a Sun Fire V1280 or Netra 1280 System From Firmware Version 5.17.0 to 5.13.x	96
Using the <code>lom -G</code> Command	97
Examples	98
▼ To Upgrade a Sun Fire V1280 or Netra 1280 System Running Firmware Version 5.13.x to 5.17.0 Using the <code>lom -G</code> Command	100
▼ To Downgrade the Firmware on a Sun Fire V1280 or Netra 1280 System From Firmware Version 5.17.0 to 5.13.x Using the <code>lom -G</code> Command	101
10. CPU/Memory Board Replacement and Dynamic Reconfiguration (DR)	103
Dynamic Reconfiguration	103
Overview	103

Command Line Interface	103
DR Concepts	104
Quiescence	104
Suspend-Safe and Suspend-Unsafe Devices	104
Attachment Points	105
DR Operations	106
Hot-Plug Hardware	106
Conditions and States	106
Board States and Conditions	107
Board Receptacle States	107
Board Occupant States	107
Board Conditions	108
Component States and Conditions	108
Component Receptacle States	108
Component Occupant States	108
Component Conditions	109
Component Types	109
Nonpermanent and Permanent Memory	109
Limitations	110
Memory Interleaving	110
Reconfiguring Permanent Memory	110
Command Line Interface	111
The <code>cfgadm</code> Command	111
Displaying Basic Board Status	111
Displaying Detailed Board Status	112
Command Options	113
Testing Boards and Assemblies	114
▼ To Test a CPU/Memory Board	114

Installing or Replacing CPU/Memory Boards	116
▼ To Install a New Board	116
▼ To Hot-Swap a CPU/Memory Board	117
▼ To Remove a CPU/Memory Board From the System	118
▼ To Disconnect a CPU/Memory Board Temporarily	118
Troubleshooting	119
Unconfigure Operation Failure	119
CPU/Memory Board Unconfiguration Failures	119
Configure Operation Failure	122
CPU/Memory Board Configuration Failure	122
Glossary	125
Index	129

Figures

FIGURE 1-1	I/O Ports	2
FIGURE 1-2	System Indicator Board	5
FIGURE 2-1	Power (On/Standby) Switch	13
FIGURE 3-1	Navigation Procedures	38
FIGURE 4-1	System Controller Logging	44
FIGURE 7-1	Auto Diagnosis and Recovery Process	66
FIGURE 8-1	Sun Fire entry-level midrange systems IB_SSC PCI Physical Slot Designations for IB6	79
FIGURE 8-2	System Indicators	80
FIGURE 10-1	Details of the Display for <code>cfgadm -av</code>	113

Tables

TABLE 1-1	Selected Management Tasks	3
TABLE 1-2	System Indicator LED Functions	5
TABLE 6-1	POST Configuration Parameters	58
TABLE 7-1	Diagnostic and Operating System Recovery Parameters	70
TABLE 8-1	CPU and Memory Agent ID Assignment	76
TABLE 8-2	I/O Assembly Type and Number of Slots	76
TABLE 8-3	Number and Name of I/O Assemblies per System	77
TABLE 8-4	I/O Controller Agent ID Assignments	77
TABLE 8-5	IB_SSC Assembly PCI Device Mapping	78
TABLE 8-6	System Fault Indicator States	81
TABLE 8-7	Blacklisting Component Names	83
TABLE 8-8	Checking Temperature Conditions Using the <code>showenvironment</code> Command	87
TABLE 10-1	Types of DR Operation	106
TABLE 10-2	Board Receptacle States	107
TABLE 10-3	Board Occupant States	108
TABLE 10-4	Board Conditions	108
TABLE 10-5	Component Occupant States	109
TABLE 10-6	Component Conditions	109
TABLE 10-7	Component Types	109
TABLE 10-8	DR Board States from the System Controller (SC)	111

TABLE 10-9	<code>cfgadm -c</code> Command Options	114
TABLE 10-10	<code>cfgadm -x</code> Command Options	114
TABLE 10-11	Diagnostic Levels	115

Code Samples

CODE EXAMPLE 2-1	Hardware Reset Output from the System Controller	18
CODE EXAMPLE 2-2	Output From the <code>setupnetwork</code> Command	21
CODE EXAMPLE 2-3	Installing the LOM Drivers	23
CODE EXAMPLE 2-4	Installing the LOM Utility	25
CODE EXAMPLE 2-5	Installing the LOM Manual Pages	26
CODE EXAMPLE 5-1	Sample Output from the <code>lom -c</code> Command	47
CODE EXAMPLE 5-2	Sample Output from the <code>lom -l</code> Command	47
CODE EXAMPLE 5-3	Sample LOM Event Log (Oldest Event Reported First)	48
CODE EXAMPLE 5-4	Sample Output from the <code>lom -f</code> Command	49
CODE EXAMPLE 5-5	Sample Output from the <code>lom -v</code> Command	49
CODE EXAMPLE 5-6	Sample Output from the <code>lom -t</code> Command	52
CODE EXAMPLE 6-1	POST Output Using <code>max</code> Setting	60
CODE EXAMPLE 6-2	Setting SCPOST Diagnostic Level to <code>min</code>	62
CODE EXAMPLE 6-3	SCPOST Output with Diagnostic Level Set to <code>min</code>	63
CODE EXAMPLE 7-1	Example of Auto-Diagnosis Event Message Displayed on the Console	67
CODE EXAMPLE 7-2	Example of Message Output for Automatic Domain Recovery After the Operating System Heartbeat Stops	68
CODE EXAMPLE 7-3	Example of Console Output for Automatic Recovery After the Operating System Does Not Respond to Interrupts	68
CODE EXAMPLE 7-4	Domain Diagnosis Event Message – Non-fatal Domain Hardware Error	69
CODE EXAMPLE 7-5	Example of Auto-Diagnostic Message	71

CODE EXAMPLE 7-6	<code>showboards</code> Command Output – Disabled and Degraded Components	72
CODE EXAMPLE 7-7	<code>showcomponent</code> Command Output – Disabled Components	73
CODE EXAMPLE 7-8	<code>showerrorbuffer</code> Command output – Hardware Error	74
CODE EXAMPLE 9-1	Downloading the <code>lw8pci.flash</code> Image	98
CODE EXAMPLE 9-2	Downloading the <code>lw8cpu.flash</code> Image	98
CODE EXAMPLE 10-1	Output of the Basic <code>cfgadm</code> Command	112
CODE EXAMPLE 10-2	Output of the <code>cfgadm -av</code> Command	112

Preface

This book provides an overview of the system and presents a step-by-step description of common administration procedures. It explains how to configure and manage system controller firmware on the Sun Fire™ family of entry-level midrange servers—the E2900/V1280/Netra 1280 systems. It also explains how to remove and replace components and perform firmware upgrades. It contains information about security, troubleshooting, and a glossary of technical terms.

How This Book Is Organized

Chapter 1 describes the system controller, and explains board states, describes redundant system components, minimum system configurations, and reliability, serviceability, and availability.

Chapter 2 describes how to power on and set up the system for the first time.

Chapter 3 describes how to navigate within the system controller.

Chapter 4 explains System Controller message logging.

Chapter 5 describes how to use the LOM from the Solaris console.

Chapter 6 describes how to run the power-on self-test (POST).

Chapter 7 describes the automatic diagnosis and domain restoration features of the firmware.

Chapter 8 describes troubleshooting information including LEDs, system faults, displaying diagnostic information, displaying system configuration information, disabling components (blacklisting) and mapping device path names to physical system devices.

Chapter 9 provides information on firmware updates, including how to update the flash PROMs and the procedure for updating the system controller firmware.

Chapter 10 describes Dynamic Reconfiguration and the procedures you can use.

Using UNIX Commands

This book assumes you are experienced with the UNIX[®] operating environment. If you are not experienced with the UNIX operating environment, see one or more of the following for this information:

- AnswerBook2[™] online documentation for the Solaris operating environment.
- Other software documentation that you received with your system.

Typographic Conventions

Typeface	Meaning	Examples
AaBbCc123	The names of commands, files, and directories; on-screen computer output	Edit your <code>.login</code> file. Use <code>ls -a</code> to list all files. % You have mail.
AaBbCc123	What you type, when contrasted with on-screen computer output	% su Password:
<i>AaBbCc123</i>	Book titles, new words or terms, words to be emphasized	Read Chapter 6 in the <i>User's Guide</i> . These are called <i>class</i> options. You <i>must</i> be superuser to do this.
	Command-line variable; replace with a real name or value	To delete a file, type <code>rm filename</code> .

Shell Prompts

Shell	Prompt
C shell	<i>machine_name%</i>
C shell superuser	<i>machine_name#</i>
Bourne shell and Korn shell	\$
Bourne shell and Korn shell superuser	#
LOM shell	lom>

Related Documentation

Type of Book	Title	Part Number
System Controller	<i>Sun Fire Entry-Level Midrange System Controller Command Reference Manual</i>	817-5232-10

Accessing Sun Documentation

You can view and print a broad selection of Sun™ documentation, including localized versions, at:

<http://www.sun.com/documentation>

Sun Welcomes Your Comments

Sun is interested in improving its documentation and welcomes your comments and suggestions. You can email your comments to Sun at:

docfeedback@sun.com

Please include the part number of your document (817-5233-10) in the subject line of your email.

Overview

This chapter introduces the features for the Sun Fire family of entry-level midrange servers—the E2900/V1280/Netra 1280 systems. The objective of this chapter is to provide you with a basic understanding of the features of Sun Fire entry-level midrange systems.

The procedural overview of how to set up your system, and detailed procedures, is covered in Chapter 2.

System Controller

The System Controller is an embedded system resident on the IB_SSC Assembly which connects to the system baseplane. The system controller is responsible for providing the Lights Out Management (LOM) functions which include power on sequencing, sequencing module power on self tests (POST), environmental monitoring, fault indication and alarms.

The System Controller provides an RS232 serial interface and one 10/100 Ethernet interface. Access to the LOM command line interface and the Solaris/OpenBoot PROM console is shared and obtained through these interfaces.

System Controller functions include:

- Monitoring the system
- Providing the Solaris and OpenBoot PROM consoles
- Providing the virtual TOD (time of day)
- Performing environmental monitoring
- Performing system initialization
- Coordinating POST

The software application running on the System Controller provides a command line interface for you to modify system settings.

I/O Ports

The following ports are on the rear of the system:

- Console serial (RS-232) port (RJ45)
- Reserved serial (RS-232) port (RJ45)
- Two Gigabit Ethernet ports (RJ-45)
- Alarms port (DB15)
- System Controller 10/100 Ethernet port (RJ45)
- UltraSCSI port
- Up to six PCI ports (five 33 MHz, one 66 MHz)

Their locations are shown in FIGURE 1-1.

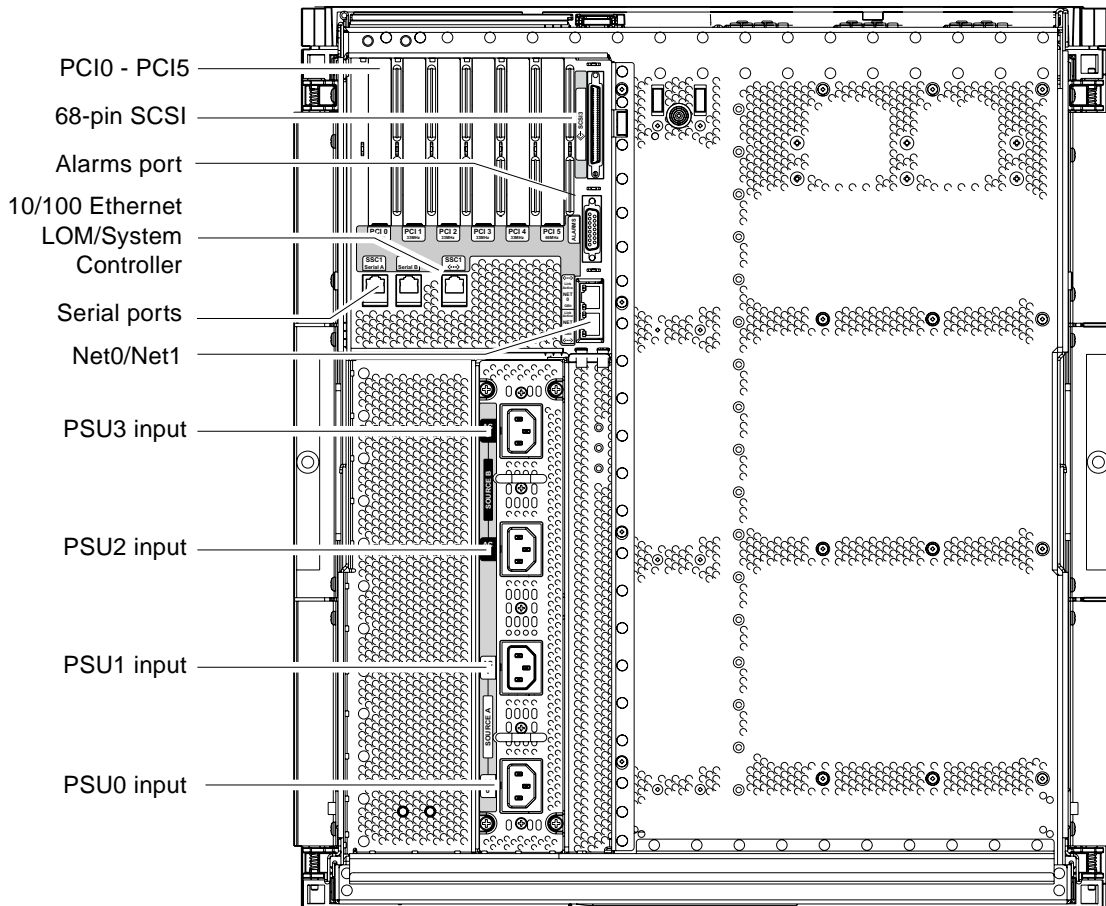

FIGURE 1-1 I/O Ports

The console serial port and 10/100 Ethernet port can be used to access the System Controller.

Use the console serial port to connect directly to an ASCII terminal or a NTS (network terminal server). Connecting the System Controller board with a serial cable enables you to access the System Controller command line interface with an ASCII terminal or an NTS.

Use the 10/100 Ethernet port to connect the System Controller to the network.

LOM Prompt

The LOM prompt provides the command line interface for the System Controller. It is also the place where console messages are displayed.

The prompt is:

```
lom>
```

Some of the system management tasks are shown in TABLE 1-1.

TABLE 1-1 Selected Management Tasks

System Controller Management Tasks	System Controller Commands To Use
Configuring the System Controller.	password, setescape, seteventreporting, setupnetwork, setupsc
Configuring the system.	setalarm, setlocator
Powering boards on and off and powering the system on or off.	poweron, poweroff, reset, shutdown
Testing the CPU/Memory board.	testboard
Resetting the System Controller.	resetsc
Marking components as faulty or OK.	disablecomponent, enablecomponent
Upgrading firmware.	flashupdate
Displaying the current System Controller settings.	showescape, showeventreporting, shownetwork, showsc

TABLE 1-1 Selected Management Tasks *(Continued)*

System Controller Management Tasks	System Controller Commands To Use
Displaying the current system state.	showalarm, showboards, showcomponent, showenvironment, showfault, showhostname, showlocator, showlogs, showmodel, showresetstate
Setting the date, time, and time zone.	setdate
Displaying the date and time.	showdate

Solaris Console

If the Solaris operating environment, the OpenBoot PROM, or POST is running, you can access the Solaris console. When you connect to the Solaris console, you will be in one of the following modes of operation:

- Solaris operating environment console (% or # prompts)
- OpenBoot PROM (ok prompt)
- System will be running POST and you can view the POST output.

To switch between these prompts and the LOM prompt, refer to “Switching Between the Different Consoles” on page 37.

Environmental Monitoring

There are sensors that monitor temperature, voltage, and cooling.

The System Controller polls these sensors in a timely manner and makes the environmental data available. If necessary, the System Controller shuts down various components to prevent damage.

For instance, in the case of an overtemperature, the System Controller notifies the Solaris operating environment of the overtemperature and the operating environment takes action. In the case of extreme overtemperature, the System Controller software can shut down the system without first notifying the operating environment.

System Indicator Board

The system indicator board contains the On/Standby switch and indicator LEDs as shown in FIGURE 1-2.

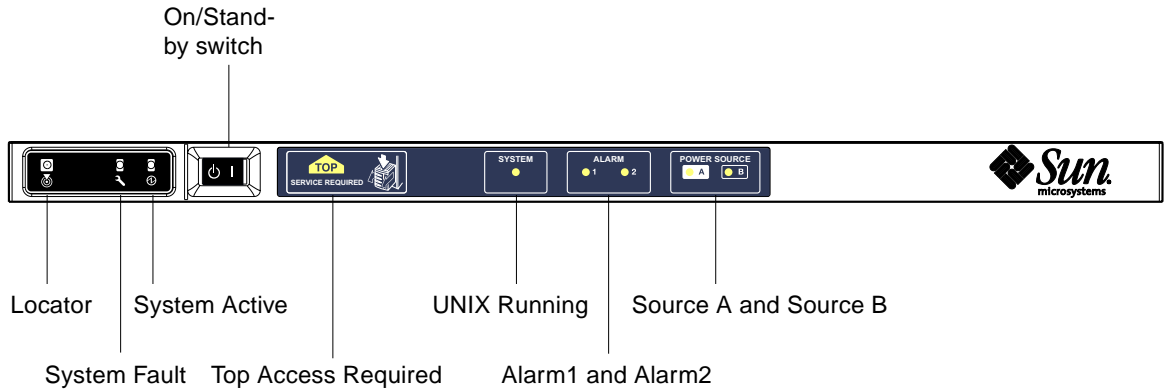

FIGURE 1-2 System Indicator Board

The indicator LEDs function as shown in TABLE 1-2.

TABLE 1-2 System Indicator LED Functions

Name	Color	Function
Locator*	White	Normally off; can be lit by user command
System Fault*	Amber	Lights when the LOM detects a fault
System Active*	Green	Lights when power is applied to the system
Top Access	Amber	Lights when a fault occurs in a FRU which can only be replaced from the top of the system
UNIX Running	Green	Lights when Solaris is running.
Alarm1 and Alarm2	Green	Light when triggered by events as specified in the LOM
Source A and Source B	Green	Light when the relevant power feeds are present

* This indicator is repeated on the rear of the system.

Reliability, Availability, and Serviceability (RAS)

Reliability, availability, and serviceability (RAS) are features of this system. The descriptions of these features are:

- *Reliability* is the probability that a system stays operational for a specified time period when operating under normal environmental conditions. Reliability differs from availability in that reliability involves only system failure, whereas availability depends on both failure and recovery.
- *Availability*, also known as average availability, is the percentage of time that a system is available to perform its functions correctly. Availability can be measured at the system level or in the context of the availability of a service to an end client. The “system availability” is likely to impose an upper limit on the availability of any products built on top of that system.
- *Serviceability* measures the ease and effectiveness of maintenance and system repair for the product. There is no single well-defined metric, because serviceability can include both Mean Time to Repair (MTTR) and diagnosability.

The following sections provide details on RAS. For more hardware-related information on RAS, refer to the *Sun Fire E2900 System Service Manual* or *Sun Fire V1280/Netra 1280 Service Manual*, as appropriate. For RAS features that involve the Solaris operating environment, refer to the *Sun Hardware Platform Guide*.

Reliability

The software reliability features include:

- Disabling Components or Boards and Power-On Self-Test (POST)
- Manual Disabling of Components
- Environmental Monitoring

The reliability features also improve system availability.

Disabling Components or Boards and Power-On Self-Test (POST)

The power-on self-test (POST) is part of powering on the system. If the board or component failed testing, POST disables components or boards. The `showboards` command displays the board as either being failed or degraded. The system, running the Solaris operating environment, is booted only with components that have passed POST testing.

Manual Disabling of Components

The system controller provides component-level status and user-controlled modification of component status.

Set the component location status by running the `setls` command from the console. The component location status is updated at the next domain reboot, board power cycle, or POST execution (for example, POST is run whenever you perform a setkeyswitch on or off operation).

Note – The `enablecomponent` and `disablecomponent` commands have been replaced by the `setls` command. These commands were formerly used to manage component resources. While the `enablecomponent` and `disablecomponent` commands are still available, it is suggested that you use the `setls` command to control the configuration of components into or out of the system.

The `showcomponent` command displays status information about the component, including whether or not it has been disabled.

Environmental Monitoring

The System Controller monitors the system's temperature, cooling, and voltage sensors. The System Controller provides the latest environmental status information to the Solaris operating environment. If hardware needs to be powered off, the System Controller notifies the Solaris operating environment to perform a system shutdown.

Availability

The software availability features include:

- Dynamic Reconfiguration.
- Automatic fault auto-diagnosis engine.

- Power Failure.
- System Controller Reboot.
- Host Watchdog.

Dynamic Reconfiguration

The following components can be dynamically reconfigured:

- Hard disk drives.
- CPU/Memory boards.
- Power supplies.
- Fans.

Power Failure

On recovery from a power outage, the System Controller attempts to restore the system to its previous state.

System Controller Reboot

The System Controller can be rebooted and will start up and resume management of the system. The reboot does not disturb the currently running Solaris operating environment.

Host Watchdog

The System Controller monitors the state of the Solaris operating environment and will initiate a reset if Solaris stops responding.

Serviceability

The software serviceability features promote the efficiency and timeliness of providing routine as well as emergency service to the system.

- LEDs.
- Nomenclature.
- System Controller error logging.
- System Controller XIR (eXternally Initiated Reset) support.

LEDs

All field-replaceable units (FRUs) that are accessible from outside the system have LEDs that indicate their state. The System Controller manages all the LEDs in the system, with the exception of the power supply LEDs, which are managed by the power supplies. For a discussion of LED functions, refer to the appropriate board or device chapter of the *Sun Fire E2900 System Service Manual* or *Sun Fire V1280/Netra 1280 Service Manual*, as appropriate.

Nomenclature

The System Controller, the Solaris operating environment, the power-on self-test (POST), and the OpenBoot PROM error messages use FRU name identifiers that match the physical labels in the system. The only exception is the OpenBoot PROM nomenclature used for I/O devices, which use the device path names as described in Chapter 8, to indicate I/O devices during device probing.

System Controller Error Logging

System Controller error messages are automatically notified to the Solaris operating environment. The System Controller also has an internal buffer where error messages are stored. You can display the System Controller logged events, stored in the System Controller message buffer, by using the `showlogs` command.

System Controller XIR (eXternally Initiated Reset) Support

The System Controller `reset` command enables you to recover from a hung system and extract a Solaris operating environment `core` file..

Starting and Setting Up Sun Fire Entry-Level Midrange Systems

This chapter describes how to power on your system using the System Controller command line interface (LOM prompt), how to set up the System Controller using the `setupnetwork` command, and how to boot the Solaris operating environment.

This chapter contains the following topics:

- “Installing and Cabling Hardware” on page 12
- “Using the Power (On/Standby) Switch” on page 13
- “Powering On and Off” on page 14
- “Setting Up the System” on page 19
- “Installing and Booting the Solaris Operating Environment” on page 22
- “Resetting the System” on page 26

The list below summarizes the major steps you must perform to power on and set up the system, which are explained using step-by-step procedures.

1. Install and cable the hardware.
2. Apply external power to the hardware.
3. Set the date and time for the system.
4. Set the password for the System Controller.
5. Set up system-specific parameters with the `setupnetwork` command.
6. Power on all hardware with the `poweron` command.
7. If the Solaris operating environment is not pre-installed, install it.
8. Boot the Solaris operating environment.
9. Install the Lights Out Management packages from the Solaris Supplementary CD.

Installing and Cabling Hardware

- 1. Connect a terminal to the System Controller board serial port.**

Refer to FIGURE 1-1.

- 2. Set up the terminal to use the same baud rate as the serial port.**

The serial port settings of the System Controller board are:

- 9600 8N1:
 - 9600 baud
 - 8 data bits
 - No parity
 - 1 stop bit

More details can be found in the *Sun Fire E2900 System Installation Guide* or *Sun Fire V1280/Netra 1280 Systems Installation Guide*, as appropriate.

Using the Power (On/Standby) Switch



Caution – The power switch is not an On/Off switch, it is an On/Standby switch. It does not isolate the equipment.

The power (On/Standby) switch of the Sun Fire entry-level midrange systems system is a rocker type, momentary action switch. It controls only low voltage signals and no high voltage circuits pass through it.

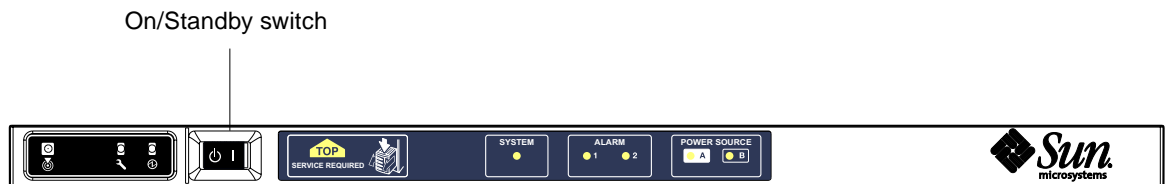

FIGURE 2-1 Power (On/Standby) Switch

The symbols on the switch are:

| On *On symbol.*

- Press and release to power on the server. This is the equivalent of the LOM `poweron` command.

⏻ Standby *Standby symbol.*

- Press for less than four seconds to initiate an orderly shutdown of the system into Standby mode. This is equivalent to issuing the `shutdown` command at the `lom>` prompt. This is the method to use under normal operation.
- Press and hold down for more than four seconds to perform a system power down to standby mode. This is equivalent to issuing the `poweroff` command at the `lom>` prompt. This process is not interruptible. You should ensure that Solaris is cleanly shut down before powering a system to standby mode otherwise data is at risk of being lost. The recommended method of powering down to standby is by using the `shutdown` command at the LOM prompt.

Use the LOM `setupsc` command to prevent accidental operation of the On/Standby switch.

Powering On and Off

Powering On

▼ Initial Power-On

1. **Ensure all power cables are connected and external circuit breakers are switched on.**
2. **The system will enter Standby mode.**

The only indicator LEDs to be illuminated on the system indicator board are the Source A and Source B indicators. The IB_SSC assembly Active LED will also be illuminated, but not visible from the front of the system.

▼ Powering On from Standby Mode

Powering the system on from Standby mode can be achieved in either of two ways:

- Operating the On/Standby switch
- Sending the `poweron` command via the LOM port.

If the `auto-boot?` variable has been set in the OBP, the system will automatically boot into the Solaris operating environment.

Using the On/Standby Switch

1. **Check that power is applied to the system and that it is correctly in Standby mode.**

The only indicator LEDs to be illuminated on the system indicator board are the Source A and Source B indicators. The IB_SSC assembly Active LED will also be illuminated, but not visible from the front of the system.

2. **Momentarily press the On/Standby switch to the right.**

The system will power on completely. The System Active indicator will be illuminated in addition to the Source A and Source B indicators. The system will execute the power on self tests (POST).

Using the LOM `poweron` Command

- At the `lom>` prompt, type:

```
lom>poweron
```

The System Controller will first power on all the power supplies, followed by the fan tray. Finally the System Controller will power on the system boards. If the value of the OpenBoot PROM variable `auto-boot?` is `true` then the system will also boot the Solaris operating environment.

Individual modules can also be powered on using the `poweron` command. For further details see the *Sun Fire Entry-Level Midrange System Controller Command Reference Manual*.

The System Active indicator will be illuminated in addition to the Source A and Source B indicators. The system will execute the power on self tests (POST).

Note – The `poweron all` command only powers on individual components; it does not boot Solaris.

Refer to the *Sun Fire Entry-Level Midrange System Controller Command Reference Manual* for a full description of the `poweron` command.

Bringing the System to Standby Mode

This can be achieved in one of five ways:

- Using the UNIX `shutdown` command.
- Sending the `shutdown` command via the LOM port
- Sending the `shutdown` command using the On/Standby switch
- Sending the `poweroff` command via the LOM port
- Sending the `poweroff` command using the On/Standby switch

Note – You should ensure that Solaris is cleanly shut down before powering a system to standby mode otherwise data is at risk of being lost.

Using the Solaris shutdown Command

- **At the system prompt, type:**

```
# shutdown -i5
```

The system will power off to standby mode. The only indicator LEDs to be illuminated on the system indicator board are the Source A and Source B indicators. The IB_SSC assembly Active LED will also be illuminated, but not visible from the front of the system.

Sending the LOM shutdown Command

Use the LOM `shutdown` command to perform a clean shutdown of Solaris followed by a power down of all modules and system chassis to standby mode.

Note – If Solaris is running this command will attempt to halt the system cleanly before powering down the system to standby mode, and is the equivalent of the Solaris `init 5` command.

At the `lom>` prompt, type:

```
lom>shutdown
```

After Solaris has been stopped, the system will power off to standby mode. The only indicator LEDs to be illuminated on the system indicator board are the Source A and Source B indicators. The IB_SSC assembly Active LED will also be illuminated, but not visible from the front of the system.

Refer to the *Sun Fire Entry-Level Midrange System Controller Command Reference Manual* for a full description of the LOM `shutdown` command.

Sending the shutdown Command Using the On/Standby Switch

- **Momentarily press the system On/Standby switch to the left.**

This initiates an orderly shutdown of the system into Standby mode. This is equivalent to issuing the `shutdown` command at the `lom>` prompt.

Sending the LOM `poweroff` Command

Use the `poweroff` command when you wish to power down all modules and system chassis to standby mode.

- **At the `lom>` prompt, type:**

```
lom>poweroff
```

```
This will abruptly terminate Solaris.  
Do you want to continue? [no]
```

Only answer `yes` if you wish to forcibly power down the system regardless of the state of Solaris. Under normal operation you should use the `shutdown` command.

Type `y` to continue or press Return to cancel the command.

The system will power off to standby mode. The only indicator LEDs to be illuminated on the system indicator board are the Source A and Source B indicators. The IB_SSC assembly Active LED will also be illuminated, but not visible from the front of the system.

Refer to the *Sun Fire Entry-Level Midrange System Controller Command Reference Manual* for a full description of the `poweroff` command.

Sending the `poweroff` Command Using the On/Standby Switch

Only use this method if you wish to forcibly power down the system regardless of the state of Solaris. Under normal operation you should send the `shutdown` command either from the `lom>` prompt or from the On/Standby Switch (see “Sending the shutdown Command Using the On/Standby Switch” on page 16).

- **Press the On/Standby switch to the left and hold it for at least four seconds.**

The system will power down to standby mode. The only indicator LEDs to be illuminated on the system indicator board are the Source A and Source B indicators. The IB_SSC assembly Active LED will also be illuminated, but not visible from the front of the system.

After Powering On

You will see the following output on the System Controller serial port connection:

CODE EXAMPLE 2-1 Hardware Reset Output from the System Controller

```
Hardware Reset...

@(#) SYSTEM CONTROLLER(SC) POST 23 2002/03/22 18:03
PSR = 0x044010e5
PCR = 0x04004000

Basic sanity checks done.
Skipping POST ...
ERI Device Present
Getting MAC address for SSC1
Using SCC MAC address
MAC address is 0:3:xx:xx:xx:xx
Hostname: some_name
Address: xxx.xxx.xxx.xxx
Netmask: 255.255.255.0
Attached TCP/IP interface to eri unit 0
Attaching interface lo0...done
Gateway: xxx.xxx.xxx.xxx
interrupt: 100 Mbps half duplex link up

                Copyright 2001-2002 Sun Microsystems, Inc. All rights reserved.
                Use is subject to license terms.

Lights Out Management Firmware
RTOS version: 23
ScApp version: 5.13.0007 LW8_build0.7
SC POST diag level: off

The date is Friday, July 19, 2002, 3:48:50 PM BST.

Fri Jul 19 15:48:51 some_name lom: Boot: ScApp 5.13.0007, RTOS 23
Fri Jul 19 15:48:54 some_name lom: SBBC Reset Reason(s): Power On Reset
Fri Jul 19 15:48:54 some_name lom: Initializing the SC SRAM
Fri Jul 19 15:48:59 some_name lom: Caching ID information
Fri Jul 19 15:49:00 some_name lom: Clock Source: 75MHz
Fri Jul 19 15:49:02 some_name lom: /N0/PS0: Status is OK
Fri Jul 19 15:49:03 some_name lom: /N0/PS1: Status is OK
Fri Jul 19 15:49:03 some_name lom: Chassis is in single partition mode.
Fri Jul 19 15:49:05 some_name lom: Cold boot detected: recovering active domains
```

CODE EXAMPLE 2-1 Hardware Reset Output from the System Controller (*Continued*)

```
Hardware Reset...
Fri Jul 19 15:49:06 some_name lom: NOTICE: /N0/FT0 is powered off

Connected.

lom>
```

Setting Up the System

After powering on, you must set up your system using the System Controller `setdate` and `setupnetwork` commands described in this chapter.

This section contains the following topics:

- “To Set the Date and Time” on page 19
- “To Configure Network Parameters” on page 20
- “To Install and Boot the Solaris Operating Environment” on page 22

▼ To Set the Date and Time

Note – If your time zone area is using daylight or summer time, this is set automatically.

- **Set the date, time, and time zone for the system using the `setdate` command at the LOM prompt:**

The following example shows setting the time zone to Pacific Standard Time (PST) using the offset from Greenwich mean time (GMT), date, and time to Thursday, April 20, 2000 at 18 hours 15 minutes and 10 seconds.

```
lom>setdate -t GMT-8 042018152000.10
```

If Solaris is running, use the Solaris `date` command instead.

For more information on the `setdate` command, refer to the *Sun Fire Entry-Level Midrange System Controller Command Reference Manual*.

▼ To Set Up the Password

1. At the LOM prompt, type the System Controller `password` command.
2. At the `Enter new password:` prompt, type in your password.
3. At the `Enter new password again:` prompt, re-type in your password.

```
lom>password
Enter new password:
Enter new password again:
lom>
```

In the event that your password has been lost or forgotten, contact SunService for advice.

▼ To Configure Network Parameters

The Sun Fire entry-level midrange systems system can be administered from the System Controller LOM prompt and from Solaris. There are two ways to access the LOM/Console connection.

- Through the System Controller Serial port connection.
- Through a Telnet (network) connection using the 10/100 Ethernet port.

Note – The system can be administered solely through the serial port, but if you want to use the 10/100 Ethernet port it is recommended that a separate secure subnet be used for this connection. The Telnet connection capability is not enabled by default. If you want to use Telnet to administer the system, you must set the connection type to `telnet`, using the `setupnetwork` command.

- At the LOM prompt type `setupnetwork:`

```
lom>setupnetwork
```

Note – If you press the Return key after each question, the current value will not be changed.

See the *Sun Fire Entry-Level Midrange System Controller Command Reference Manual* for full details of the `setupnetwork` command. CODE EXAMPLE 2-2 shows an example of the `setupnetwork` command.

CODE EXAMPLE 2-2 Output From the setupnetwork Command

```
lom>setupnetwork
Network Configuration
-----
Is the system controller on a network? [yes]:
Use DHCP or static network settings? [static]:
Hostname [hostname-sc]:
IP Address [123.xxx.xxx.xxx]:
Netmask [255.255.255.0]:
Gateway [123.xxx.xxx.xxx]:
DNS Domain [xxx.somewhere.com]:
Primary DNS Server [123.xxx.xxx.xxx]:
Secondary DNS Server [123.xxx.xxx.xxx]:
Connection type (telnet, none)[none]:
lom>
```

Use the information in CODE EXAMPLE 2-2 as a guide for the information you need to enter for each parameter value entry.

Installing and Booting the Solaris Operating Environment

To use LOM commands you must install the Lights Out Management 2.0 packages (SUNWlommu, SUNWlomr and SUNWlomm) from the Solaris Supplementary CD.

▼ To Install and Boot the Solaris Operating Environment

1. Access the LOM prompt.

See Chapter 3.

2. Power on the system. Type `poweron`.

Depending on the setting of the OpenBoot PROM `auto-boot?` parameter the system will attempt to boot Solaris or will remain at the OpenBoot PROM `ok` prompt. The default setting is `true` which will attempt to initiate a Solaris boot. If the setting of `auto-boot?` is `false` or there is no bootable Solaris image installed then you will get the OpenBoot PROM `ok` prompt.

```
lom>poweron
<POST messages displayed here . . . >
. . .
. . .
ok
```

3. If necessary, install the Solaris operating environment.

Refer to your installation documentation, which is available with your Solaris operating environment release.

4. At the `ok` prompt, boot the Solaris operating environment by typing the OpenBoot PROM `boot` command:

```
ok boot [device]
```

For the optional *device* parameter, see the OpenBoot PROM `devalias` command, which displays the predefined aliases.

After the Solaris operating environment is booted, the `login:` prompt is displayed.

```
login:
```

▼ To Install the Lights Out Management Packages

The three LOM packages needed on a Sun Fire entry-level midrange systems are `SUNWlomu` (LOMlite Utilities (`usr`)), `SUNWlomm` (LOMlite manual pages), and `SUNWlomr` (LOM drivers). These are available on the Solaris Supplementary CD.

Note – The latest patches to these packages are available from SunSolve. It is strongly advised that you obtain the latest versions of patches from SunSolve and install them on your Sun Fire E2900/V1280/Netra 1280 to make use of the latest LOM utility updates.

▼ To Install the LOM Drivers

- As root, type:

CODE EXAMPLE 2-3 Installing the LOM Drivers

```
# pkgadd -d . SUNWlomr

Processing package instance <SUNWlomr> from </var/tmp>

LOMlite driver (root)
(sparc) 2.0,REV=2000.08.22.14.14
Copyright 2000 Sun Microsystems, Inc. All rights reserved.
## Executing checkinstall script.
Using </> as the package base directory.
## Processing package information.
## Processing system information.
   9 package pathnames are already properly installed.
## Verifying package dependencies.
## Verifying disk space requirements.
## Checking for conflicts with packages already installed.
## Checking for setuid/setgid programs.

This package contains scripts which will be executed with super-user
permission during the process of installing this package.

Do you want to continue with the installation of <SUNWlomr> [y,n,?] y

Installing LOMlite driver (root) as <SUNWlomr>
```

CODE EXAMPLE 2-3 Installing the LOM Drivers (Continued)

```
### Installing part 1 of 1.
20 blocks
i.drivers (INFO): Starting
i.drivers (INFO): Installing /var/tmp/SUNWlomr/reloc/platform/sun4u/kernel/drv/lom
i.drivers (INFO): Installing /var/tmp/SUNWlomr/reloc/platform/sun4u/kernel/drv/lomp
i.drivers (INFO): Installing /var/tmp/SUNWlomr/reloc/platform/sun4u/kernel/drv/sparcv9/lom
i.drivers (INFO): Installing /var/tmp/SUNWlomr/reloc/platform/sun4u/kernel/drv/sparcv9/lomp
i.drivers (INFO): Installing /var/tmp/SUNWlomr/reloc/platform/sun4u/kernel/drv/sparcv9/lomv

i.drivers (INFO): Identified drivers 'lom lomp lomv'
i.drivers (INFO): Cleaning up old driver 'lom'...
Cleaning up old devlink entry 'type=ddi_pseudo;name=SUNW,lom lom'
i.drivers (INFO): Cleaning up old driver 'lomp'...
Cleaning up old devlink entry 'type=ddi_pseudo;name=lomp lomp'
i.drivers (INFO): Cleaning up old driver 'lomv'...
Cleaning up old devlink entry 'type=ddi_pseudo;name=SUNW,lomv \M0
type=ddi_pseudo;name=lomv \M0'
i.drivers (INFO): Cleaning up old driver 'lomh'...
Cleaning up old devlink entry 'type=ddi_pseudo;name=SUNW,lomh lom'

i.drivers (INFO): Adding driver 'lomp'...
driver = 'lomp'
aliases = ''
link = 'lomp'
spec = 'lomp'

Adding devlink entry 'type=ddi_pseudo;name=lomp lomp'
adding driver with aliases '' perm '* 0644 root sys'
devfsadm: driver failed to attach: lomp
Warning: Driver (lomp) successfully added to system but failed to attach

i.drivers (INFO): Adding driver 'lomv'...
driver = 'lomv'
aliases = 'SUNW,lomv'
link = 'SUNW,lomv lomv'
spec = '\M0'

Adding devlink entry 'type=ddi_pseudo;name=SUNW,lomv \M0'
Adding devlink entry 'type=ddi_pseudo;name=lomv \M0'
adding driver with aliases 'SUNW,lomv' perm '* 0644 root sys'
devfsadm: driver failed to attach: lomv
Warning: Driver (lomv) successfully added to system but failed to attach

i.drivers (INFO): Adding driver 'lom'...
driver = 'lom'
aliases = 'SUNW,lomh SUNW,lom'
link = 'SUNW,lomh SUNW,lom'
spec = 'lom'

Adding devlink entry 'type=ddi_pseudo;name=SUNW,lomh lom'
Adding devlink entry 'type=ddi_pseudo;name=SUNW,lom lom'
adding driver with aliases 'SUNW,lomh SUNW,lom' perm '* 0644 root sys'
```

CODE EXAMPLE 2-3 Installing the LOM Drivers (Continued)

```
devfsadm: driver failed to attach: lom
Warning: Driver (lom) successfully added to system but failed to attach
i.drivers (SUCCESS): Finished

[ verifying class <drivers> ]

Installation of <SUNWlomr> was successful.
#
```

Note – The WARNING messages concerning lomr, lomv and lom driver attachment seen during the installation of the SUNWlomr package can be safely ignored since the SUNWlomr package is not used on the Sun Fire entry-level midrange systems system. However, the presence of the package is required to allow successful upgrade via future patches.

▼ To Install the LOM Utility

- As root, type:

CODE EXAMPLE 2-4 Installing the LOM Utility

```
# pkgadd -d . SUNWlomu

Processing package instance <SUNWlomu> from
</cdrrom/suppcd_s28u7_multi_s28u7_supp.08all/Lights_Out_Management_2.0/Product>

LOMlite Utilities (usr)
(sparc) 2.0,REV=2000.08.22.14.14
Copyright 2000 Sun Microsystems, Inc. All rights reserved.
Using </> as the package base directory.
## Processing package information.
## Processing system information.
  4 package pathnames are already properly installed.
## Verifying package dependencies.
## Verifying disk space requirements.
## Checking for conflicts with packages already installed.
## Checking for setuid/setgid programs.

Installing LOMlite Utilities (usr) as <SUNWlomu>

## Installing part 1 of 1.
1432 blocks

Installation of <SUNWlomu> was successful.
#
```

▼ To Install the LOM Manual Pages

- As root, type:

CODE EXAMPLE 2-5 Installing the LOM Manual Pages

```
# pkgadd -d . SUNWlomm

Processing package instance <SUNWlomm> from
</cdrom/suppcd_s28u7_multi_s28u7_supp.08all/Lights_Out_Management_2.0/Product>

LOMlite manual pages
(sparc) 2.0,REV=2000.08.22.14.14
Copyright 2000 Sun Microsystems, Inc. All rights reserved.
Using </> as the package base directory.
## Processing package information.
## Processing system information.
    5 package pathnames are already properly installed.
## Verifying disk space requirements.
## Checking for conflicts with packages already installed.
## Checking for setuid/setgid programs.

Installing LOMlite manual pages as <SUNWlomm>

## Installing part 1 of 1.
71 blocks

Installation of <SUNWlomm> was successful.
```

Resetting the System

▼ To Forcibly Reset the System

The `reset` command is used to reset the system in the event of a system hang or hardware problem. If Solaris is running then you will be prompted to confirm this action:

```
lom>reset
```

```
This will abruptly terminate Solaris.  
Do you want to continue? [no] y  
NOTICE: XIR on CPU 3
```

By default, `reset` uses XIR (externally initiated reset) to reset the CPU processors in the system. The externally initiated reset forces control of the processors into the OpenBoot PROM and begins the OpenBoot PROM's error reset recovery actions. The error reset recovery actions preserve most of the Solaris states to allow the collection of data need for debugging the hardware and software, including a Solaris operating environment core file. After saving the debug information, if the value of the OpenBoot PROM variable `auto-boot?` is `true`, the system will boot Solaris. The OpenBoot PROM's error reset recovery actions are controlled by setting the OpenBoot PROM `error-reset-recovery` configuration variable.

`reset` is prevented in standby, and the message `reset not allowed, domain A keyswitch is set to off` is displayed.

Note – If the system is still hung (you cannot log into the Solaris operating environment and typing the `break` command did not force control of the system back into the OpenBoot PROM `ok` prompt), after you type the `reset` command for the first time, you must next type `reset -a` in order to reset everything.

The `reset -a` command is equivalent to the OpenBoot PROM `reset-all` word.

▼ To Reset the System Controller

Use the `resetsc` command to reset the System Controller. This can be used in the event of a hardware or software problem causing the System Controller Application to malfunction.

```
lom>resetsc
```

```
Are you sure you want to reboot the system controller now? [no] y
```

This will cause the System Controller to reset, execute the System Controller POST level specified using the `setupsc` command and restart the LOM software.

Console Navigation Procedures

This chapter explains step-by-step procedures and provides illustrations for connecting to the system and navigating between the LOM shell and the console. It also explains how to terminate a System Controller session.

Topics covered in this chapter include:

- “Establishing a LOM/Console Connection” on page 30
 - “To Connect to an ASCII Terminal” on page 30
 - “To Connect to a Network Terminal Server” on page 32
 - “To Connect to Serial Port B of a Workstation” on page 33
 - “To Access the LOM/Console Using the Telnet Command” on page 35
- “Switching Between the Different Consoles” on page 37
 - “To Break to the LOM Prompt” on page 39
 - “To Connect to the Solaris Console from the LOM Prompt” on page 39
 - “To Break to the LOM Prompt from the OpenBoot PROM” on page 40
 - “To Break to the OpenBoot Prompt when Solaris is Running” on page 41
 - “To Terminate a Session If You Are Connected To the System Controller Through the Serial Port” on page 41
 - “To Terminate a Session If You Are Connected to the System Controller with telnet” on page 42

Establishing a LOM/Console Connection

There are two ways to access the LOM/Console connection.

- Through the System Controller serial port (direct) connection.
- Through a Telnet (network) connection using the 10/100 Ethernet port.



Caution – Starting with 5.17.0 firmware, network connections are disabled by default. Unless you enable network connections using the `setupnetwork` command, you must use a serial (direct connection) to access the LOM/Console.

Under normal operation (when Solaris is running or the system is in the OpenBoot PROM) connecting to the LOM/Console will automatically select a connection to the Solaris console, otherwise a connection to the LOM prompt is made.

The LOM prompt is:

```
lom>
```

Accessing the LOM/Console Using the Serial Port

With the serial port, you can connect to one of three types of device.

- ASCII terminal
- Network terminal server
- Workstation

Please see the *Sun Fire E2900 System Installation Guide* or *Sun Fire V1280/Netra 1280 Systems Installation Guide*, as appropriate, for details of how to make the physical connections.

The procedure is different for each type of device.

▼ To Connect to an ASCII Terminal

1. **If the LOM password has been set (and the previous connection was logged out) you will be prompted for a password.**

```
Enter Password:
```

Enter the correct password as previously set up using the `password` command.

2. If the password is accepted the System Controller indicates that a connection has been made.

If the system is in standby mode the `lom` prompt is automatically displayed.

```
Connected.
```

```
lom>
```

Otherwise type a single carriage return and the Solaris console prompt will be displayed.

```
Connected.
```

```
#
```

3. If a connection to the LOM/console is already established over the network port then you will be offered the opportunity to forcefully connect by logging out the other connection:

```
Enter Password:
```

```
The console is already in use.
```

```
Host:      somehost.acme.com
```

```
Connected: May 24 10:27
```

```
Idle time: 00:23:17
```

```
Force logout of other user? (y/n) y
```

```
Connected.
```

```
lom>
```

Otherwise type a single carriage return and the Solaris console prompt will be displayed.

```
Connected.  
#
```

▼ To Connect to a Network Terminal Server

1. You will be provided with a menu of various servers to which you can connect. Select the required server.
2. If the LOM password has been set (and the previous connection was logged out) you will be prompted for a password.

```
Enter Password:
```

Enter the correct password as previously set up using the `password` command.

3. If the password is accepted the System Controller indicates that a connection has been made.

If the system is in standby mode the `lom` prompt is automatically displayed.

```
Connected.  
lom>
```

Otherwise type a single carriage return and the Solaris console prompt will be displayed.

```
Connected.  
#
```

4. If a connection to the LOM/console is already established over the network port then you will be offered the opportunity to forcefully connect by logging out the other connection:

```
Enter Password:

The console is already in use.

Host:      somehost.acme.com
Connected: May 24 10:27
Idle time: 00:23:17

Force logout of other user? (y/n) y

Connected.

lom>
```

Otherwise type a single carriage return and the Solaris console prompt will be displayed.

```
Connected.

#
```

▼ To Connect to Serial Port B of a Workstation

1. At the Solaris shell prompt type:

```
# tip hardware
```

See the `tip` man page for a complete description of the `tip` command.

2. If the LOM password has been set (and the previous connection was logged out) you will be prompted for a password.

```
Enter Password:
```

Enter the correct password as previously set up using the `password` command.

3. If the password is accepted the System Controller indicates that a connection has been made.

If the system is in standby mode the lom prompt is automatically displayed.

```
Connected.  
lom>
```

Otherwise type a single carriage return and the Solaris console prompt will be displayed.

```
Connected.  
#
```

4. If a connection to the LOM/console is already established over the network port then you will be offered the opportunity to forcefully connect by logging out the other connection:

```
Enter Password:  
  
The console is already in use.  
  
Host:      somehost.acme.com  
Connected: May 24 10:27  
Idle time: 00:23:17  
  
Force logout of other user? (y/n) y  
  
Connected.  
  
lom>
```

▼ To Access the LOM/Console Using the Telnet Command

In order to be able to access the LOM/System Controller via `telnet` to the 10/100 Ethernet port you must first set up the interface.

Refer to “To Configure Network Parameters” on page 20.

1. **Type the `telnet` command at the Solaris prompt to connect to the System Controller.**

```
% telnet <system_controller_hostname>
Trying 123.123.123.95...
Connected to interpol-sc.
Escape character is '^]'.
```

2. **If the LOM password has been set up you will be prompted for a password.**

```
# telnet <system_controller_hostname>
Trying 123.123.123.95...
Connected to interpol-sc.
Escape character is '^]''.
Enter password:
```

3. **Enter the correct password as previously set up using the `password` command.**
4. **If the password is accepted the System Controller indicates that a connection has been made.**

If the system is in standby mode the `lom` prompt is automatically displayed.

```
Connected.

lom>
```

Otherwise type a single carriage return and the Solaris console prompt will be displayed.

```
Connected.

#
```

5. If a connection to the LOM/Console is already established over the serial port then you will be offered the opportunity to forcefully connect by logging out the other connection:

```
# telnet <system_controller_hostname>
Trying 123.123.123.95...
Connected to interpol-sc.
Escape character is '^]'.

The console is already in use.

Host:      somehost.acme.com
Connected: May 24 10:27
Idle time: 00:23:17

Force logout of other user? (y/n) y

Connected.

lom>
```

In this case you should first use the LOM `logout` command on the serial connection to make the connection available. Refer to the *Sun Fire Entry-Level Midrange System Controller Command Reference Manual* for further details.

▼ To Disconnect from the LOM/Console

When you have finished using the LOM/Console you can disconnect your connection by using the `logout` command.

On the serial port the response is:

```
lom>logout
Connection closed.
```

When connected over the network the response is:

```
lom>logout
Connection closed.
Connection to <system controller host> closed by foreign host.
$
```

Switching Between the Different Consoles

The System Controller console connection provides access to the System Controller LOM command line interface or the Solaris/OpenBoot PROM console.

This section describes the procedures how to navigate between the:

- LOM prompt.
- Solaris system console.
- OpenBoot PROM.

These procedures are summarized in FIGURE 3-1

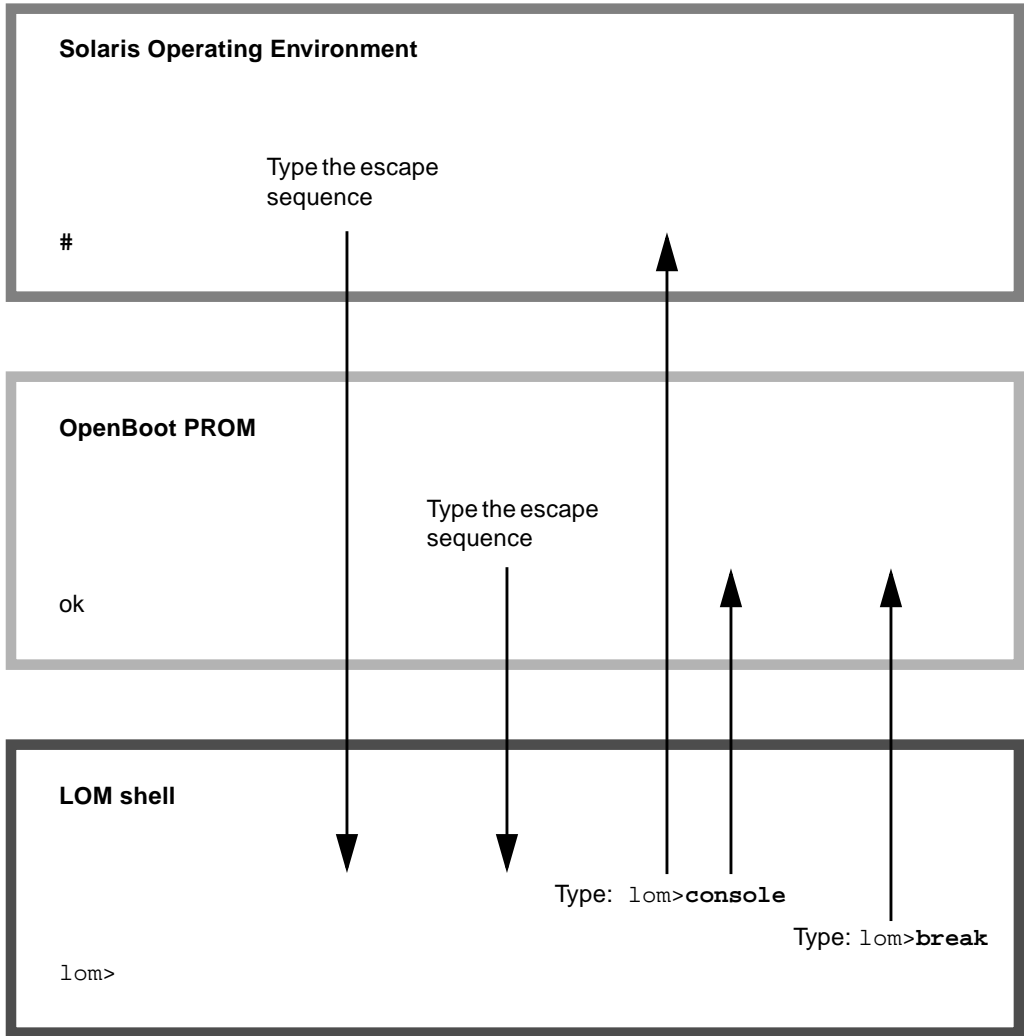

FIGURE 3-1 Navigation Procedures

▼ To Break to the LOM Prompt

- **When connected to the Solaris console, typing the *escape sequence* will take the console into the LOM prompt.**

By default the escape sequence is set to '#.'. That is, a # sign followed by a period.

For instance, if the escape sequence is the default of #. you will see:

```
lom>
```

Selecting an Escape Sequence

If you are typing at the console and type the first character of the escape sequence, there is a one second delay before the character appears on the screen. This is because the system waits to see if the next character in the escape sequence is about to be typed. The second character must be typed within this one-second window. If all the characters in the escape sequence are typed then the lom> prompt appears. If the next character to be typed is not the next character in the escape sequence, then the characters belonging to the escape sequence that were typed are output to the screen.

It is recommended that you choose an escape sequence that does not start with a sequence of characters that is frequently typed at the console, otherwise the delay between your striking the keys and the character appearing on the screen may be confusing.

▼ To Connect to the Solaris Console from the LOM Prompt

- **To connect to the Solaris console, use the `console` command from the LOM prompt, then type a carriage return.**

If Solaris is running the system will respond with the Solaris prompt:

```
lom>console  
#
```

If the system was in the OpenBoot PROM then the system will respond with the OpenBoot PROM prompt:

```
lom>console
{2} ok
```

If the system is in standby mode, the following message will be generated:

```
lom>console
Solaris is not active
```

▼ To Break to the LOM Prompt from the OpenBoot PROM

- **The process of moving from the OpenBoot PROM to the LOM prompt is the same as moving from Solaris to the LOM prompt.**

Type the sequence of escape characters (default #.).

```
{2} ok
lom>
```

▼ To Break to the OpenBoot Prompt when Solaris is Running

- When the Solaris operating environment is running the usual effect of sending a break signal to the console is to force entry to the OpenBoot PROM or kernel debugger.

Do this by using the break command from the LOM prompt:

```
lom>break
This will suspend Solaris.
Do you want to continue? [no] y
Type 'go' to resume
debugger entered.

{1} ok
```

▼ To Terminate a Session If You Are Connected To the System Controller Through the Serial Port

- If you are at the Solaris prompt or the OpenBoot PROM go to LOM prompt by typing the escape sequence, then terminate the LOM prompt session by typing `logout` followed by a single carriage return:

```
lom>logout
```

- If you are connected through a terminal server invoke the terminal server's command to disconnect the connection.
- If the connection was established using a `tip` command then type the `tip` exit sequence `~.`:

```
~.
```

▼ To Terminate a Session If You Are Connected to the System Controller with `telnet`

- If you are at the Solaris prompt or the OpenBoot PROM, go to the LOM prompt by typing the escape sequence and terminate the LOM prompt session by using the `logout` command.

The telnet session will terminate automatically:

```
lom>logout
Connection closed by foreign host.
%
```

System Controller Message Logging

The System Controller generates timestamped messages for system events, processes such as when powering on, booting, powering off, changes to hot pluggable units, environmental warnings, and so forth.

The messages are initially stored in the System Controller onboard memory in a circular 128-message buffer (note that a single message can span multiple lines). In addition, the System Controller sends the messages to the Solaris host when it is running Solaris, and these are processed by the system log daemon (`syslogd`). When Solaris is running, messages are sent at the time they are generated by the System Controller. Retrieval of messages not already copied from the System Controller takes place at Solaris boot time or when the System Controller is reset.

Messages can also be displayed at the Solaris prompt by using the `lom(1m)` utility (see Chapter 5).

Typically, the messages are stored on the Solaris host in the `/var/adm/messages` file, the only limiting factor being the available disk space.

Messages that are held in the System Controller message buffer are volatile and are not retained if the power is removed from the System Controller by loss of both power sources, less than two power supplies are operational, removal of the `IB_SSC`, or the System Controller is reset. Messages stored on the system disk are available when Solaris is rebooted.

The display of the messages on the shared Solaris/System Controller console port, when at the `lom>` prompt is controlled by the `seteventreporting` command (see the *Sun Fire Entry-Level Midrange System Controller Command Reference Manual*). This determines whether a message is printed at the `lom>` prompt at the time the message is logged, and also whether it is posted to the Solaris logging system so that it is written to `/var/adm/messages`.

Note – Systems equipped with the enhanced memory SC (also known as SC V2), have an additional 112 Kbytes area of SC memory that is used to store firmware messages. This memory is non-volatile; messages stored there are not deleted when the SC is powered off (the original LOM history buffer is dynamic, losing information when powered off). The messages stored in the persistent history logs of the SC V2 can be displayed at the `lom>` prompt by using the `showlogs -p` command or the `showerrorbuffer -p` command. Please refer to the appropriate sections in *Sun Fire Entry-Level Midrange System Controller Command Reference Manual* for their description.

FIGURE 4-1 illustrates the two message buffers.

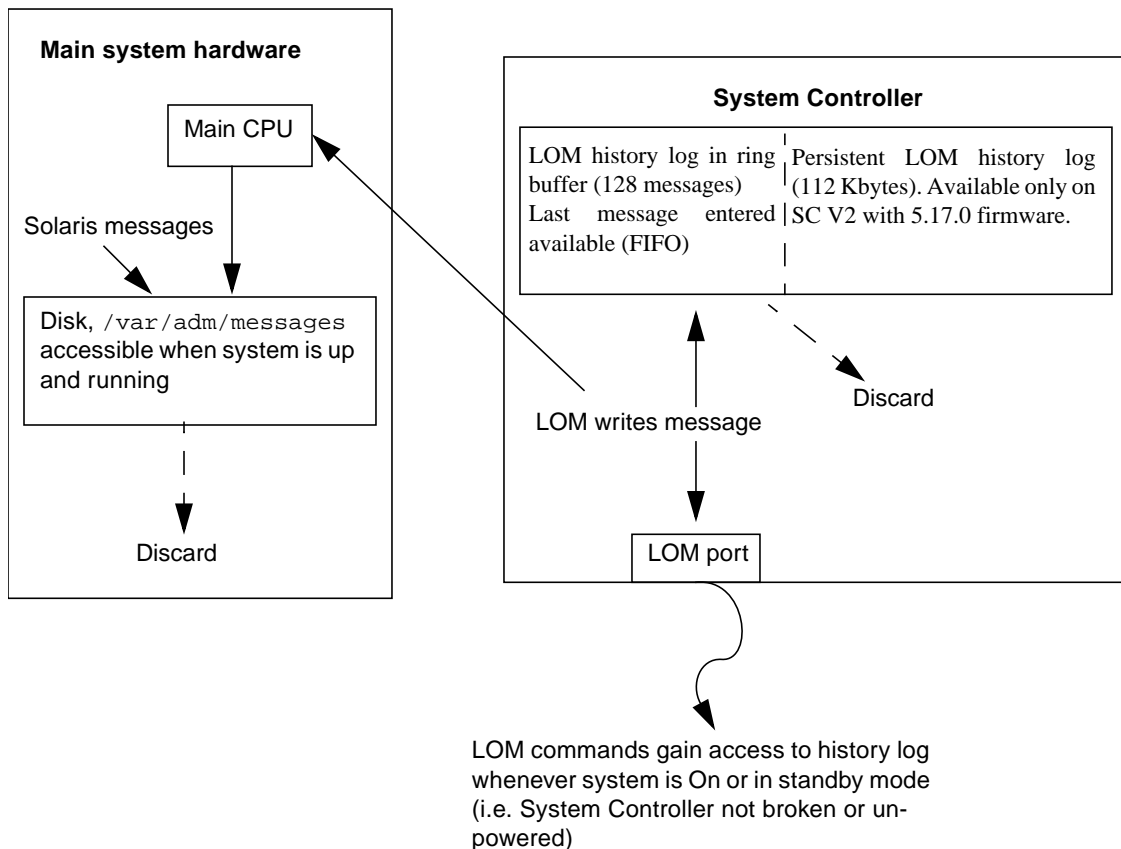

FIGURE 4-1 System Controller Logging

Using Lights Out Management and the System Controller from Solaris

This chapter explains how to use the LOM-specific commands available in Solaris for monitoring and managing a Sun Fire entry-level midrange systems system. To use these commands you should install the Lights Out Management 2.0 packages (SUNWlomr, SUNWlomu and SUNWlomm) from the Solaris Supplemental CD. Refer to “To Install the Lights Out Management Packages” on page 23 for a description of how to install the LOM packages.

Note – The latest patches to these packages is available from SunSolve in patch 110208. It is strongly advised that the latest version of patch 110208 is obtained from SunSolve and is installed on the Sun Fire entry-level midrange systems to make use of the latest LOM utility updates.

The chapter contains the following sections:

- “Monitoring the System From Solaris” on page 46
- “Other LOM Tasks Performed From Solaris” on page 54

LOM Command Syntax

```
lom [-c] [-l] [-f] [-v] [-t] [-a] [-G] [-X]
lom -e <n>, [x]
lom -A on|off <n>
lom -E on|off
```

where:

-c displays LOM configuration.

- l displays the status of the Fault and Alarms LEDs.
- e displays the event log.
- f displays fan status. This information is also displayed in the output from the Solaris `prtdiag -v` command.
- v displays the status of the voltage sensors. This information is also displayed in the output from the Solaris `prtdiag -v` command.
- t displays temperature information. This information is also displayed in the output from the Solaris `prtdiag -v` command.
- a displays all component status data.
- A turns alarms on and off.
- X changes the escape sequence.
- E switches event logging to the console on and off.
- G upgrades the firmware.

Monitoring the System From Solaris

There are two ways of interrogating the LOM device (System Controller) or of sending it commands to perform:

- By executing LOM commands from the `lom>` shell prompt
For information about how to do this, see Chapter 3.
- By executing LOM-specific Solaris commands from the UNIX `#` prompt
These commands are described in this chapter.

The Solaris commands described in this section, which are all available from the UNIX `#` prompt, run the `/usr/sbin/lom` utility.

Where appropriate, the command lines given in this section are accompanied by typical output from the commands.

Viewing Online LOM Documentation

- To view the manual pages for the LOM utility, type:

```
# man lom
```

Viewing the LOM Configuration (`lom -c`)

- To view the current LOM configuration, type:

CODE EXAMPLE 5-1 Sample Output from the `lom -c` Command

```
# lom -c
LOM configuration settings:
serial escape sequence=#.
serial event reporting=default
Event reporting level=fatal, warning & information
firmware version=5.17.0, build 5.0
product ID=Netra T12
```

Checking the Status of the Fault LED and Alarms (`lom -l`)

- To check whether the System Fault LED and alarms are on or off, type:

CODE EXAMPLE 5-2 Sample Output from the `lom -l` Command

```
# lom -l
LOM alarm states:
Alarm1=off
Alarm2=off
Alarm3=on
Fault LED=off
#
```

Alarms 1 and 2 are software flags. They are associated with no specific conditions but are available to be set by your own processes or from the command line (see “Turning Alarms On and Off (`lom -A`)” on page 54). Alarm 3 is UNIX Running and is not user-configurable.

Viewing the Event Log (lom -e)

- To see the event log, type:

```
# lom -e n,[x]
```

where *n* is the number of reports (up to 128) that you want to see and *x* specifies the level of reports you are interested in. There are four levels of event:

1. Fatal events
2. Warning events
3. Information events
4. User events (not used on Sun Fire entry-level midrange systems systems)

If you specify a level, you will see reports for that level and above. For example, if you specify level 2, you will see reports of level 2 and level 1 events. If you specify level 3, you will see reports of level 3, level 2, and level 1 events.

If you do not specify a level, you will see reports of level 3, level 2, and level 1 events.

CODE EXAMPLE 5-3 shows a sample event log display.

CODE EXAMPLE 5-3 Sample LOM Event Log (Oldest Event Reported First)

```
# lom -e 11
LOMlite Event Log:
Fri Jul 19 15:16:00 commando-sc lom: Boot: ScApp 5.13.0007, RTOS
23
Fri Jul 19 15:16:06 commando-sc lom: Caching ID information
Fri Jul 19 15:16:08 commando-sc lom: Clock Source: 75MHz
Fri Jul 19 15:16:10 commando-sc lom: /N0/PS0: Status is OK
Fri Jul 19 15:16:11 commando-sc lom: /N0/PS1: Status is OK
Fri Jul 19 15:16:11 commando-sc lom: Chassis is in single
partition mode.
Fri Jul 19 15:27:29 commando-sc lom: Locator OFF
Fri Jul 19 15:27:46 commando-sc lom: Alarm 1 ON
Fri Jul 19 15:27:52 commando-sc lom: Alarm 2 ON
Fri Jul 19 15:28:03 commando-sc lom: Alarm 1 OFF
Fri Jul 19 15:28:08 commando-sc lom: Alarm 2 OFF
```

Checking the Fans (lom -f)

- To check status of the fans, type:

CODE EXAMPLE 5-4 Sample Output from the lom -f Command

```
# lom -f
Fans:
1 OK speed self-regulating
2 OK speed self-regulating
3 OK speed self-regulating
4 OK speed self-regulating
5 OK speed self-regulating
6 OK speed self-regulating
7 OK speed self-regulating
8 OK speed self-regulating
9 OK speed 100 %
10 OK speed 100 %
#
```

If you need to replace a fan, contact your local Sun sales representative and quote the part number of the component you need. For information, see the *Sun Fire E2900 System Service Manual* or *Sun Fire V1280/Netra 1280 Service Manual*, as appropriate.

The information output from this command is also contained in the output from the Solaris `prtdiag -v` command.

Checking the Internal Voltage Sensors (lom -v)

The `-v` option displays the status of the Sun Fire entry-level midrange systems system internal voltage sensors.

- To check the status of the supply rails and internal voltage sensors, type:

CODE EXAMPLE 5-5 Sample Output from the lom -v Command

```
# lom -v
Supply voltages:
1 SSC1      v_1.5vdc0   status=ok
2 SSC1      v_3.3vdc0   status=ok
3 SSC1      v_5vdc0     status=ok
4 RP0       v_1.5vdc0   status=ok
5 RP0       v_3.3vdc0   status=ok
6 RP2       v_1.5vdc0   status=ok
7 RP2       v_3.3vdc0   status=ok
8 SB0       v_1.5vdc0   status=ok
```

CODE EXAMPLE 5-5 Sample Output from the `lom -v` Command (Continued)

```
9 SB0 v_3.3vdc0 status=ok
10 SB0/P0 v_cheetah0 status=ok
11 SB0/P1 v_cheetah1 status=ok
12 SB0/P2 v_cheetah2 status=ok
13 SB0/P3 v_cheetah3 status=ok
14 SB2 v_1.5vdc0 status=ok
15 SB2 v_3.3vdc0 status=ok
16 SB2/P0 v_cheetah0 status=ok
17 SB2/P1 v_cheetah1 status=ok
18 SB2/P2 v_cheetah2 status=ok
19 SB2/P3 v_cheetah3 status=ok
20 IB6 v_1.5vdc0 status=ok
21 IB6 v_3.3vdc0 status=ok
22 IB6 v_5vdc0 status=ok
23 IB6 v_12vdc0 status=ok
24 IB6 v_3.3vdc1 status=ok
25 IB6 v_3.3vdc2 status=ok
26 IB6 v_1.8vdc0 status=ok
27 IB6 v_2.4vdc0 status=ok
```

System status flags:

```
1 PS0 status=okay
2 PS1 status=okay
3 FT0 status=okay
4 FT0/FAN0 status=okay
5 FT0/FAN1 status=okay
6 FT0/FAN2 status=okay
7 FT0/FAN3 status=okay
8 FT0/FAN4 status=okay
9 FT0/FAN5 status=okay
10 FT0/FAN6 status=okay
11 FT0/FAN7 status=okay
12 RP0 status=okay
13 RP2 status=okay
14 SB0 status=ok
15 SB0/P0 status=online
16 SB0/P0/B0/D0 status=okay
17 SB0/P0/B0/D1 status=okay
18 SB0/P0/B0/D2 status=okay
19 SB0/P0/B0/D3 status=okay
20 SB0/P1 status=online
21 SB0/P1/B0/D0 status=okay
22 SB0/P1/B0/D1 status=okay
23 SB0/P1/B0/D2 status=okay
24 SB0/P1/B0/D3 status=okay
25 SB0/P2 status=online
26 SB0/P2/B0/D0 status=okay
27 SB0/P2/B0/D1 status=okay
```

CODE EXAMPLE 5-5 Sample Output from the `lom -v` Command (Continued)

```
28 SB0/P2/B0/D2 status=okay
29 SB0/P2/B0/D3 status=okay
30 SB0/P3      status=online
31 SB0/P3/B0/D0 status=okay
32 SB0/P3/B0/D1 status=okay
33 SB0/P3/B0/D2 status=okay
34 SB0/P3/B0/D3 status=okay
35 SB2        status=ok
36 SB2/P0     status=online
37 SB2/P0/B0/D0 status=okay
38 SB2/P0/B0/D1 status=okay
39 SB2/P0/B0/D2 status=okay
40 SB2/P0/B0/D3 status=okay
41 SB2/P1     status=online
42 SB2/P1/B0/D0 status=okay
43 SB2/P1/B0/D1 status=okay
44 SB2/P1/B0/D2 status=okay
45 SB2/P1/B0/D3 status=okay
46 SB2/P2     status=online
47 SB2/P2/B0/D0 status=okay
48 SB2/P2/B0/D1 status=okay
49 SB2/P2/B0/D2 status=okay
50 SB2/P2/B0/D3 status=okay
51 SB2/P3     status=online
52 SB2/P3/B0/D0 status=okay
53 SB2/P3/B0/D1 status=okay
54 SB2/P3/B0/D2 status=okay
55 SB2/P3/B0/D3 status=okay
56 IB6       status=ok
57 IB6/FAN0  status=okay
58 IB6/FAN1  status=okay
#
```

The information output from this command is also contained in the output from the Solaris `prtdiag -v` command.

Checking the Internal Temperature (lsm -t)

- To check the internal temperature of the system and also the system's warning and shutdown threshold temperatures, type:

CODE EXAMPLE 5-6 Sample Output from the lsm -t Command

```
# lsm -t
System Temperature Sensors:
 1 SSC1      t_sbbc0      36 degC : warning 102 degC : shutdown 107 degC
 2 SSC1      t_cbh0       45 degC : warning 102 degC : shutdown 107 degC
 3 SSC1      t_ambient0   23 degC : warning 82 degC : shutdown 87 degC
 4 SSC1      t_ambient1   21 degC : warning 82 degC : shutdown 87 degC
 5 SSC1      t_ambient2   28 degC : warning 82 degC : shutdown 87 degC
 6 RP0       t_ambient0   22 degC : warning 82 degC : shutdown 87 degC
 7 RP0       t_ambient1   22 degC : warning 53 degC : shutdown 63 degC
 8 RP0       t_sdc0       62 degC : warning 102 degC : shutdown 107 degC
 9 RP0       t_ar0        47 degC : warning 102 degC : shutdown 107 degC
10 RP0       t_dx0        62 degC : warning 102 degC : shutdown 107 degC
11 RP0       t_dx1        65 degC : warning 102 degC : shutdown 107 degC
12 RP2       t_ambient0   23 degC : warning 82 degC : shutdown 87 degC
13 RP2       t_ambient1   22 degC : warning 53 degC : shutdown 63 degC
14 RP2       t_sdc0       57 degC : warning 102 degC : shutdown 107 degC
15 RP2       t_ar0        42 degC : warning 102 degC : shutdown 107 degC
16 RP2       t_dx0        53 degC : warning 102 degC : shutdown 107 degC
17 RP2       t_dx1        56 degC : warning 102 degC : shutdown 107 degC
18 SB0       t_sdc0       48 degC : warning 102 degC : shutdown 107 degC
19 SB0       t_ar0        39 degC : warning 102 degC : shutdown 107 degC
20 SB0       t_dx0        49 degC : warning 102 degC : shutdown 107 degC
21 SB0       t_dx1        54 degC : warning 102 degC : shutdown 107 degC
22 SB0       t_dx2        57 degC : warning 102 degC : shutdown 107 degC
23 SB0       t_dx3        53 degC : warning 102 degC : shutdown 107 degC
24 SB0       t_sbbc0      53 degC : warning 102 degC : shutdown 107 degC
25 SB0       t_sbbc1      40 degC : warning 102 degC : shutdown 107 degC
26 SB0/P0    Ambient      29 degC : warning 82 degC : shutdown 87 degC
27 SB0/P0    Die          57 degC : warning 92 degC : shutdown 97 degC
28 SB0/P1    Ambient      27 degC : warning 82 degC : shutdown 87 degC
29 SB0/P1    Die          51 degC : warning 92 degC : shutdown 97 degC
30 SB0/P2    Ambient      27 degC : warning 82 degC : shutdown 87 degC
31 SB0/P2    Die          53 degC : warning 92 degC : shutdown 97 degC
32 SB0/P3    Ambient      29 degC : warning 82 degC : shutdown 87 degC
33 SB0/P3    Die          50 degC : warning 92 degC : shutdown 97 degC
34 SB2       t_sdc0       51 degC : warning 102 degC : shutdown 107 degC
35 SB2       t_ar0        40 degC : warning 102 degC : shutdown 107 degC
36 SB2       t_dx0        52 degC : warning 102 degC : shutdown 107 degC
37 SB2       t_dx1        54 degC : warning 102 degC : shutdown 107 degC
38 SB2       t_dx2        61 degC : warning 102 degC : shutdown 107 degC
39 SB2       t_dx3        53 degC : warning 102 degC : shutdown 107 degC
```

CODE EXAMPLE 5-6 Sample Output from the `lom -t` Command (Continued)

40	SB2	t_sbbc0	52 degC : warning	102 degC : shutdown	107 degC
41	SB2	t_sbbc1	42 degC : warning	102 degC : shutdown	107 degC
42	SB2/P0	Ambient	27 degC : warning	82 degC : shutdown	87 degC
43	SB2/P0	Die	54 degC : warning	92 degC : shutdown	97 degC
44	SB2/P1	Ambient	26 degC : warning	82 degC : shutdown	87 degC
45	SB2/P1	Die	53 degC : warning	92 degC : shutdown	97 degC
46	SB2/P2	Ambient	27 degC : warning	82 degC : shutdown	87 degC
47	SB2/P2	Die	51 degC : warning	92 degC : shutdown	97 degC
48	SB2/P3	Ambient	27 degC : warning	82 degC : shutdown	87 degC
49	SB2/P3	Die	51 degC : warning	92 degC : shutdown	97 degC
50	IB6	t_ambient0	29 degC : warning	82 degC : shutdown	87 degC
51	IB6	t_ambient1	29 degC : warning	82 degC : shutdown	87 degC
52	IB6	t_sdc0	68 degC : warning	102 degC : shutdown	107 degC
53	IB6	t_ar0	77 degC : warning	102 degC : shutdown	107 degC
54	IB6	t_dx0	76 degC : warning	102 degC : shutdown	107 degC
55	IB6	t_dx1	78 degC : warning	102 degC : shutdown	107 degC
56	IB6	t_sbbc0	51 degC : warning	102 degC : shutdown	107 degC
57	IB6	t_schizo0	48 degC : warning	102 degC : shutdown	107 degC
58	IB6	t_schizo1	53 degC : warning	102 degC : shutdown	107 degC

The information output from this command is also contained in the output from the Solaris `prtdiag -v` command.

Viewing All Component Status Data and the LOM Configuration Data (`lom -a`)

- To view all LOM status and configuration data, type:

```
# lom -a
```

Other LOM Tasks Performed From Solaris

This section explains how to:

- Turn the alarm indicators on and off
- Change the LOM escape sequence
- Stop the LOM from sending reports to the console
- Upgrade the firmware

Turning Alarms On and Off (`lom -A`)

There are two alarms associated with the LOM. They are associated with no specific conditions but are software flags available to be set by your own processes or from the command line.

- **To turn an alarm on from the command line, type:**

```
# lom -A on,n
```

where *n* is the number of the alarm you want to set: 1 or 2.

- **To turn the alarm off again, type:**

```
# lom -A off,n
```

where *n* is the number of the alarm you want to turn off: 1 or 2.

Changing the lom> Prompt Escape Sequence (lom -X)

The character sequence #. (hash, dot) enables you to escape from Solaris to the lom> prompt.

- **To change the default escape sequence, type:**

```
# lom -X xy
```

where xy are the alpha-numeric characters you want to use.

Note – Quotes may be required for special characters to be interpreted by the shell.

Note – If you are typing at the console and type the first character of the escape sequence, there is a one second delay before the character appears on the screen. This is because the system waits to see if the next character in the escape sequence is about to be typed. If all the characters in the escape sequence are typed then the lom> prompt appears. If the next character to be typed is not the next character in the escape sequence, then the characters belonging to the escape sequence that were typed are output to the screen.

Stopping LOM from Sending Reports to the Console When at the LOM Prompt (lom -E off)

LOM event reports can interfere with information you are attempting to send or receive on the console.

- **To stop the LOM from sending reports to the console, type:**

```
# lom -E off
```

To prevent LOM messages displaying when you are at the LOM prompt, turn off serial event reporting. This is equivalent to the `seteventreporting` command described in the *Sun Fire Entry-Level Midrange System Controller Command Reference Manual*.

- To turn serial event reporting on again, type:

```
# lom -E on
```

Upgrading the Firmware (`lom -G filename`)

For a full description, refer to Chapter 9.

Running POST

Each of the system boards (CPU/Memory boards and IB_SSC Assembly) contain a flash PROM that provides storage for power-on self-test (POST) diagnostics. POST tests the following:

- CPU chips
- External cache
- Memory
- Bus interconnect
- I/O ASICs
- I/O buses

POST provides several diagnostic levels which can be selected using the OpenBoot PROM variable `diag-level`. In addition, the `bootmode` command enables the POST settings to be declared for the next system reboot.

There is a separate POST which runs on the System Controller and which can be controlled using the `setupsc` command.

OpenBoot PROM Variables for POST Configuration

The OpenBoot PROM enables you to set variables that configure how POST runs. These are described in the *OpenBoot 4.x Command Reference Manual*.

You can use the OpenBoot `printenv` command to display the current settings:

```
{3} ok printenv diag-level
diag-level                init                (init)
```

You can use the OpenBoot PROM `setenv` command to change the current setting of a variable:

```
{1} ok setenv diag-level quick
diag-level=quick
```

For example, you can configure POST to run fastest by using:

```
{1} ok setenv diag-level init
diag-level=init
{1} ok setenv verbosity-level off
verbosity-level=off
```

This has the same effect as using the System Controller command `bootmode skipdiag` at the LOM prompt. The difference is that by using the OpenBoot command the settings remain permanent until you change them again.

TABLE 6-1 POST Configuration Parameters

Parameter	Value	Description
diag-level	init (default value)	Only system board initialization code is run. No testing is done. This is a very fast pass through POST.
	quick	All system board components are tested using few tests with few test patterns.
	max	All system board components are tested with all tests and test patterns, except for memory and Ecache modules. For memory and Ecache modules, all locations are tested with multiple patterns. More extensive, time-consuming algorithms are not run at this level.
	mem1	Runs all tests at the default level plus more exhaustive DRAM and SRAM test algorithms.
	mem2	This is the same as mem1 with the addition of a DRAM test that does explicit compare operations of the DRAM data.
verbosity-level	off	No status messages are displayed.
	min (default value)	Test names status messages, and error messages are displayed.
	max	Subtest trace messages are displayed.
error-level	off	No error messages are displayed.
	min	The failing test name is displayed.

TABLE 6-1 POST Configuration Parameters (*Continued*)

Parameter	Value	Description
	max (default value)	All relevant error statuses are displayed.
interleave-scope	within-board (default value)	The memory banks on a system board will be interleaved with each other.
	across-boards	The memory will be interleaved on all memory banks across all of the boards in the system.
interleave-mode	optimal (default value)	The memory is mixed-size interleaving in order to gain optimal performance.
	fixed	The memory is fixed-size interleaving.
	off	There is no memory interleaving.
reboot-on-error	false (default value)	The system will be paused when there is an error.
	true	The system will be rebooted.
use-nvramrc?		This parameter is the same as the OpenBoot PROM <code>nvramrc?</code> parameter. This parameter uses aliases that are stored in <code>nvramrc</code> .
	true	The OpenBoot PROM executes the script stored in <code>nvramrc</code> if this parameter is set to <code>true</code> .
	false (default value)	The OpenBoot PROM does not evaluate the script stored in <code>nvramrc</code> if this parameter is set to <code>false</code> .
auto-boot?		Controls booting of the Solaris operating environment.
	true (default value)	If this value is <code>true</code> , the system boots automatically after POST has run.
	false	If this parameter value is set to <code>false</code> , you will obtain the OpenBoot PROM <code>ok</code> prompt after POST runs, from which you must type a <code>boot</code> command to boot the Solaris operating environment.
error-reset-recovery		Controls the behavior of the system after an externally initiated reset (XIR) as well as a red mode trap.

TABLE 6-1 POST Configuration Parameters (*Continued*)

Parameter	Value	Description
	sync (default value)	The OpenBoot PROM invokes sync. A core file is generated. If the invocation returns, the OpenBoot PROM performs a reboot.
	none	The OpenBoot PROM prints a message describing the reset trap that triggered the error reset and passes control to the OpenBoot PROM ok prompt. The message describing the reset trap type is platform specific.
	boot	The OpenBoot PROM firmware reboots the system. A core file is not generated. Rebooting a system occurs using the OpenBoot PROM settings for diag-device or boot-device, depending on the value of the OpenBoot PROM configuration variable diag-switch?. If diag-switch? is set to true, the device names in diag-device will be the default for boot. If diag-switch? is set to false, the device names in boot-device will be the default for boot.

The default output from POST will be similar to CODE EXAMPLE 6-1.

CODE EXAMPLE 6-1 POST Output Using max Setting

```

Testing CPU Boards ...
Loading the test table from board SB0 PROM 0 ...
{/N0/SB0/P0} Running CPU POR and Set Clocks
{/N0/SB0/P1} Running CPU POR and Set Clocks
{/N0/SB0/P2} Running CPU POR and Set Clocks
{/N0/SB0/P3} Running CPU POR and Set Clocks
{/N0/SB0/P0} @(#) lpost 5.13.0007      2002/07/18 12:45
{/N0/SB0/P2} @(#) lpost 5.13.0007      2002/07/18 12:45
{/N0/SB0/P1} @(#) lpost 5.13.0007      2002/07/18 12:45
{/N0/SB0/P0} Copyright 2001 Sun Microsystems, Inc. All rights reserved.
{/N0/SB0/P0} Subtest: Setting Fireplane Config Registers
{/N0/SB0/P0} Subtest: Display CPU Version, frequency
{/N0/SB0/P0} Version register = 003e0015.21000507
{/N0/SB0/P0} Cpu/System ratio = 6, cpu actual frequency = 900
{/N0/SB0/P1} Copyright 2001 Sun Microsystems, Inc. All rights reserved.
. . .
. . .
. . . <more POST output>
. . .
. . .
pci bootbus-controller pci
Probing /ssm@0,0/pci@18,700000 Device 1 Nothing there
Probing /ssm@0,0/pci@18,700000 Device 2 Nothing there
Probing /ssm@0,0/pci@18,700000 Device 3 ide disk cdrom
Probing /ssm@0,0/pci@18,600000 Device 1 Nothing there

```

CODE EXAMPLE 6-1 POST Output Using max Setting (Continued)

```
Probing /ssm@0,0/pci@18,600000 Device 2 scsi disk tape scsi disk tape
pci pci
Probing /ssm@0,0/pci@19,700000 Device 1 Nothing there
Probing /ssm@0,0/pci@19,700000 Device 2 Nothing there
Probing /ssm@0,0/pci@19,700000 Device 3 Nothing there
Probing /ssm@0,0/pci@19,600000 Device 1 network
Probing /ssm@0,0/pci@19,600000 Device 2 network

Sun Fire V1280
OpenFirmware version 5.13.0007 (07/18/02 12:45)
Copyright 2001 Sun Microsystems, Inc. All rights reserved.
SmartFirmware, Copyright (C) 1996-2001. All rights reserved.
16384 MB memory installed, Serial #9537054.
Ethernet address 8:0:xx:xx:xx:xx, Host ID: 80xxxxxx.

NOTICE: obp_main: Extended diagnostics are now switched on.
{0} ok
```

Controlling POST With the bootmode Command

The System Controller `bootmode` command allows you to specify the boot configuration for the next system reboot only. This removes the necessity for taking the system down to the OpenBoot PROM to make these changes, for instance to the `diag-level` variable.

For example, use the following command to force the highest level of POST tests to be run prior to the next reboot:

```
lom>shutdown
lom>bootmode diag
lom>poweron
```

To force the lowest level of POST tests to be run prior to the next reboot, use:

```
lom>shutdown
lom>bootmode skipdiag
lom>poweron
```

If the system is not rebooted within 10 minutes of the `bootmode` command being issued, the `bootmode` setting is returned to `normal` and the previously-set values of `diag-level` and `verbosity-level` are applied.

For a fuller description of these commands, refer to the *Sun Fire Entry-Level Midrange System Controller Command Reference Manual*.

Controlling the System Controller POST

The System Controller Power-On Self Test is configured using the LOM `setupsc` command. This enables the System Controller POST level to be set to `off`, `min` or `max`. For a fuller description of this command, refer to the *Sun Fire Entry-Level Midrange System Controller Command Reference Manual*.

System Controller POST output only appears on the System Controller serial connection.

To set the SCPOST diagnostic level default to `min`:

CODE EXAMPLE 6-2 Setting SCPOST Diagnostic Level to `min`

```
lom>setupsc

System Controller Configuration
-----
SC POST diag Level [off]: min
Host Watchdog [enabled]:
Rocker Switch [enabled]:
Secure Mode [off]:

lom>
```

When SCPOST diag-level is set to min you will see the following output on the serial port whenever the System Controller is reset:

CODE EXAMPLE 6-3 SCPOST Output with Diagnostic Level Set to min

```
@(#) SYSTEM CONTROLLER(SC) POST 21 2001/12/11 17:11
PSR = 0x044010e5
PCR = 0x04004000

        SelfTest running at DiagLevel:0x20

SC Boot PROM          Test
        BootPROM CheckSum          Test
IU          Test
        IU instruction set          Test

        Little endian access          Test
FPU          Test
        FPU instruction set          Test
SparcReferenceMMU    Test
        SRMMU TLB RAM          Test
        SRMMU TLB Read miss          Test
        SRMMU page probe          Test
        SRMMU segment probe          Test
        SRMMU region probe          Test
        SRMMU context probe          Test
. . .
. . .
. . . <more SCPOST output>
. . .
. . .
Local I2C AT24C64      Test
        EEPROM          Device          Test
        performing eeprom sequential read

Local I2C PCF8591      Test
        VOLT_AD          Device          Test
        channel[00000001] Voltage(0x00000099) :1.49
        channel[00000002] Voltage(0x0000009D) :3.37
        channel[00000003] Voltage(0x0000009A) :5.1
        channel[00000004] Voltage(0x00000000) :0.0
Local I2C LM75         Test
        TEMP0(IIep) Device          Test
        Temperature : 24.50 Degree(C)

Local I2C LM75         Test
        TEMP1(Rio) Device          Test
        Temperature : 23.50 Degree(C)
```

CODE EXAMPLE 6-3 SCPOST Output with Diagnostic Level Set to min (*Continued*)

```
Local I2C LM75      Test
    TEMP2(CBH)    Device      Test
    Temperature : 32.0 Degree(C)

Local I2C PCF8574   Test
    Sc CSR        Device      Test
Console Bus Hub    Test
    CBH Register Access      Test
POST Complete.
```

Automatic Diagnosis and Recovery

This chapter describes the error diagnosis and domain recovery capabilities included with the firmware for Sun Fire entry-level midrange systems. This chapter explains the following:

- “Automatic Diagnosis and Recovery Overview” on page 65
- “Automatic Recovery of a Hung System” on page 67
- “Diagnosis Events” on page 68
- “Diagnostic and Recovery Controls” on page 69
- “Obtaining Auto-Diagnosis and Recovery Information” on page 70

Automatic Diagnosis and Recovery Overview

The diagnosis and recovery features are enabled by default on Sun Fire midrange systems. This section provides an overview of how these features work.

Depending on the type of hardware errors that occur and the diagnostic controls that are set, the system controller performs certain diagnosis and recovery steps, as FIGURE 7-1 shows. The firmware includes an *auto-diagnosis* (AD) engine, which detects and diagnoses hardware errors that affect the availability of a system.

Note – Although entry-level midrange systems do *not* support the multiple domains that other midrange systems support, by convention diagnostic output provides system status as the status for *Domain A*

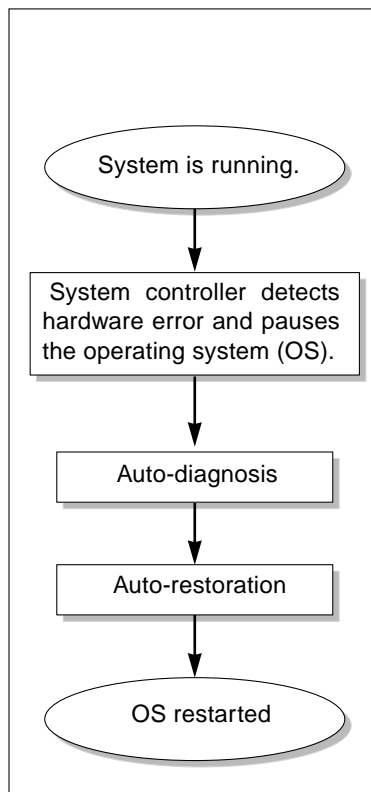

FIGURE 7-1 Auto Diagnosis and Recovery Process

The following summary describes the process shown in FIGURE 7-1:

1. System Controller detects hardware error and pauses the operating system.

2. Auto-diagnosis. The AD engine analyzes the hardware error and determines which field-replaceable units (FRUs) are associated with the hardware error.

The AD engine provides one of the following diagnosis results, depending on the hardware error and the components involved:

- Identifies a single FRU that is responsible for the error.
- Identifies multiple FRUs that are responsible for the error. Be aware that not all components listed may be faulty. The hardware error could be related to a smaller subset of the components identified.
- Indicates that the FRUs responsible for the error cannot be determined. This condition is considered to be “unresolved” and requires further analysis by your service provider.

The AD engine records the diagnosis information for the affected components and maintains this information as part of the *component health status* (CHS).

The AD reports diagnosis information through console event messages.

CODE EXAMPLE 7-1 shows an auto-diagnosis event message that appears on the console. In this example, a single FRU is responsible for the hardware error. See “Reviewing Auto-Diagnosis Event Messages” on page 70 for details on the AD message contents.

CODE EXAMPLE 7-1 Example of Auto-Diagnosis Event Message Displayed on the Console

```
[AD] Event: E2900.ASIC.AR.ADR_PERR.10473006
CSN: DomainID: A ADInfo: 1.SCAPP.17.0
Time: Fri Dec 12 09:30:20 PST 2003
FRU-List-Count: 2; FRU-PN: 5405564; FRU-SN: A08712; FRU-LOC: /N0/IB6
FRU-PN: 5404974; FRU-SN: 000274; FRU-LOC: /N0/RP2
Recommended-Action: Service action required
```

Note – Contact your service provider when you see these auto-diagnosis messages. Your service provider will review the auto-diagnosis information and initiate the appropriate service action.

- Output from the `showlogs`, `showboards`, `showcomponent`, and `showerrorbuffer` commands (see “Obtaining Auto-Diagnosis and Recovery Information” on page 70 for details on the diagnosis-related information displayed by these commands).

The output from these commands supplements the diagnosis information presented in the event messages and can be used for additional troubleshooting purposes.

3. **Auto-restoration.** During the auto-restoration process, POST reviews the component health status of FRUs that were updated by the AD engine. POST uses this information and tries to isolate the fault by deconfiguring (disabling) any FRUs from the domain that have been determined to cause the hardware error. Even if POST cannot isolate the fault, the system controller then automatically reboots the domain as part of domain restoration.

Automatic Recovery of a Hung System

The system controller automatically monitors systems for hangs when either of the following occurs:

- The operating system heartbeat stops within a designated timeout period.

The default timeout value is three minutes, but you can override this value by setting the `watchdog_timeout_seconds` parameter in the domain `/etc/systems` file. If you set the value to less than three minutes, the system controller uses three minutes (the default value) as the timeout period. For details on this system parameter, refer to the `system(4)` man page of your Solaris operating environment release.

- The domain does not respond to interrupts.

When the `host watchdog` (as described in the `setupsc` command) is enabled, the system controller automatically performs an externally initiated reset (XIR) and reboots the hung operating system. If the OBP nvram variable, `error-reset-recovery` is set to `sync`, a core file is also generated after an XIR and can be used to troubleshoot the operating system hang.

CODE EXAMPLE 7-2 shows the console message displayed when the operating system heartbeat stops.

CODE EXAMPLE 7-2 Example of Message Output for Automatic Domain Recovery After the Operating System Heartbeat Stops

```
Tue Dec 09 12:24:47 commando lom: Domain watchdog timer expired.
Tue Dec 09 12:24:48 commando lom: Using default hang-policy (RESET).
Tue Dec 09 12:24:48 commando lom: Resetting (XIR) domain.
```

CODE EXAMPLE 7-3 shows the console message displayed when the operating system does not respond to interrupts.

CODE EXAMPLE 7-3 Example of Console Output for Automatic Recovery After the Operating System Does Not Respond to Interrupts

```
Tue Dec 09 12:37:38 commando lom: Domain is not responding to interrupts.
Tue Dec 09 12:37:38 commando lom: Using default hang-policy (RESET).
Tue Dec 09 12:37:38 commando lom: Resetting (XIR) domain
```

Diagnosis Events

Starting with the 5.15.3 release, certain non-fatal hardware errors are identified by the Solaris operating environment and reported to the system controller. The system controller does the following:

- Records and maintains this information for the affected resources as part of the component health status
- Reports this information through event messages displayed on the console.

The next time that POST is run, POST reviews the health status of affected resources and if possible, deconfigures the appropriate resources from the system.

CODE EXAMPLE 7-4 shows an event message for a non-fatal domain error. When you see such event messages, contact your service provider so that the appropriate service action can be initiated. The event message information provided is described in “Reviewing Auto-Diagnosis Event Messages” on page 70.

CODE EXAMPLE 7-4 Domain Diagnosis Event Message – Non-fatal Domain Hardware Error

```
[DOM] Event: SFV1280.L2SRAM.SERD.0.60.10040000000128.7fd78d140
      CSN: DomainID: A ADInfo: 1.SF-SOLARIS-DE.5_8_Generic_116188-01
      Time: Wed Nov 26 12:06:14 PST 2003
      FRU-List-Count: 1; FRU-PN: 3704129; FRU-SN: 100ACD; FRU-LOC: /N0/SB0/P0/E0
      Recommended-Action: Service action required
```

You can obtain further information about components deconfigured by POST by using the `showboards` and `showcomponent` commands, as described in “Reviewing Component Status” on page 72.

Diagnostic and Recovery Controls

This section explains the various controls and parameters that affect the restoration features.

Diagnostic Parameters

TABLE 7-1 describes the parameter settings that control the diagnostic and operating system recovery process. The default values for the diagnostic and operating system recovery parameters are the recommended settings.

Note – If you do not use the default settings, the restoration features will not function as described in “Automatic Diagnosis and Recovery Overview” on page 65.

TABLE 7-1 Diagnostic and Operating System Recovery Parameters

Parameter	Set Using	Default Value	Description
Host Watchdog	setupsc command	enabled	Automatically reboots the domain when a hardware error is detected. Also boots the Solaris operating environment when the <code>OBP.auto-boot</code> parameter is set to <code>true</code> .
reboot-on-error	OBP setenv	true	Automatically reboots the domain when a hardware error is detected. Also boots the Solaris operating environment when the <code>OBP.auto-boot</code> parameter is set to <code>true</code> .
auto-boot	OBP setenv	true	Boots the Solaris operating environment after POST runs.
error-reset-recovery	OBP setenv	sync	Automatically reboots the system after an XIR occurs and generates a core file that can be used to troubleshoot the system hang. However, be aware that sufficient disk space must be allocated in the swap area to hold the core file.

Obtaining Auto-Diagnosis and Recovery Information

This section describes various ways to monitor hardware errors and obtain additional information about components associated with hardware errors.

Reviewing Auto-Diagnosis Event Messages

Auto-diagnosis [AD] and domain [DOM] event messages are displayed on the console and also in the following:

- The `/var/adm/messages` file, provided that you have setup the eventreporting appropriately, as described in Chapter 4.
- The `showlogs` command output, which displays the event messages logged on the console.

In systems with enhanced-memory system controllers (SC V2s), log messages are maintained in a persistent buffer. You can selectively view certain types of log messages according to message type, such as fault event messages, by using the

showlogs -p -f *filter* command. For details, refer to the showlogs command description in the *Sun Fire Entry-Level Midrange System Controller Command Reference Manual*.

The [AD] or [DOM] event messages (see CODE EXAMPLE 7-1, CODE EXAMPLE 7-4, CODE EXAMPLE 7-5, and CODE EXAMPLE 7-6) include the following information:

- [AD] or [DOM] – Beginning of the message. AD indicates that the ScApp or POST automatic diagnosis engine generated the event message. DOM indicates that the Solaris operating environment on the affected domain generated the automatic diagnosis event message.
 - Event – An alphanumeric text string that identifies the platform and event-specific information used by your service provider.
 - CSN – Chassis serial number, which identifies your Sun Fire midrange system.
 - DomainID – The domain affected by the hardware error. Entry-Level Midrange systems are always *Domain A*.
 - ADInfo – The version of the auto-diagnosis message, the name of the diagnosis engine (SCAPP or SF-SOLARIS_DE), and the auto-diagnosis engine version. For domain diagnosis events, the diagnosis engine is the Solaris operating environment (SF-SOLARIS-DE) and the version of the diagnosis engine is the version of the Solaris operating environment in use.
 - Time – The day of the week, month, date, time (hours, minutes, and seconds), time zone, and year of the auto-diagnosis.
 - FRU-List-Count – The number of components (FRUs) involved with the error and the following FRU data:
 - If a single component is implicated, the FRU part number, serial number, and location are displayed, as CODE EXAMPLE 7-1 shows.
 - If multiple components are implicated, the FRU part number, serial number, and location for each component involved is reported, as CODE EXAMPLE 7-5 shows.
- In some cases, be aware that not all the FRUs listed are necessarily faulty. The fault may reside in a subset of the components identified.
- If the SCAPP diagnosis engine cannot implicate specific components, the term UNRESOLVED is displayed, as CODE EXAMPLE 7-6 shows.
 - Recommended-Action: Service action required – Instructs the administrator to contact their service provider for further service action. Also indicates the end of the auto-diagnosis message.

CODE EXAMPLE 7-5 Example of Auto-Diagnostic Message

```
Tue Dec 02 14:35:56 commando lom: ErrorMonitor: Domain A has a SYSTEM ERROR
.
.
```

CODE EXAMPLE 7-5 Example of Auto-Diagnostic Message (Continued)

```
.
Tue Dec 02 14:35:59 commando lom: [AD] Event: E2900
CSN: DomainID: A ADInfo: 1.SCAPP.17.0
Time: Tue Dec 02 14:35:57 PST 2003
FRU-List-Count: 0; FRU-PN: ; FRU-SN: ; FRU-LOC: UNRESOLVED
Recommended-Action: Service action required
Tue Dec 02 14:35:59 commando lom: A fatal condition is detected on Domain A.
Initiating automatic restoration for this domain
```

Reviewing Component Status

You can obtain additional information about components that have been deconfigured as part of the auto-diagnosis process or disabled for other reasons by reviewing the following items:

- The showboards command output after an auto-diagnosis has occurred

CODE EXAMPLE 7-6 shows the location assignments and the status for all components in the system. The diagnostic-related information is provided in the Status column for a component. Components that have a Failed or Disabled status are deconfigured from the system. The Failed status indicates that the board failed testing and is not usable. Disabled indicates that the board has been deconfigured from the system, because it was disabled using the `setls` command or because it failed POST. Degraded status indicates that certain components on the boards have failed or are disabled, but there are still usable parts on the board. Components with degraded status are configured into the system.

You can obtain additional information about Failed, Disabled, or Degraded components by reviewing the output from the `showcomponent` command.

CODE EXAMPLE 7-6 showboards Command Output - Disabled and Degraded Components

Slot	Pwr	Component Type	State	Status
SSC1	On	System Controller V2	Main	Passed
/N0/SCC	-	System Config Card	Assigned	OK
/N0/BP	-	Baseplane	Assigned	Passed
/N0/SIB	-	Indicator Board	Assigned	Passed
/N0/SPDB	-	System Power Distribution Bd.	Assigned	Passed
/N0/PS0	On	A166 Power Supply	-	OK
/N0/PS1	On	A166 Power Supply	-	OK
/N0/PS2	On	A166 Power Supply	-	OK
/N0/PS3	On	A166 Power Supply	-	OK
/N0/FT0	On	Fan Tray	Auto Speed	Passed
/N0/RP0	On	Repeater Board	Assigned	OK

CODE EXAMPLE 7-6 showboards Command Output – Disabled and Degraded Components (*Continued*)

/N0/RP2	On	Repeater Board	Assigned	OK
/N0/SB0	On	CPU Board	Active	Passed
/N0/SB2	On	CPU Board V3	Assigned	Disabled
/N0/SB4	On	CPU Board	Active	Degraded
/N0/IB6	On	PCI I/O Board	Active	Passed
/N0/MB	-	Media Bay	Assigned	Passed

- The showcomponent command output after an auto-diagnosis has occurred

The Status column in CODE EXAMPLE 7-7 shows the status for components. The status is either enabled or disabled. The disabled components are deconfigured from the system. The POST status chs (abbreviation for component health status) flags the component for further analysis by your service provider.

Note – Disabled components that have a POST status of chs cannot be enabled by using the setls command. Contact your service provider for assistance. In some cases, subcomponents belonging to a “parent” component associated with a hardware error will also reflect a disabled status, as will the parent. You cannot re-enable the subcomponents of a parent component associated with a hardware error. Review the auto-diagnosis event messages to determine which parent component is associated with the error.

CODE EXAMPLE 7-7 showcomponent Command Output – Disabled Components

```
schostrname: SC> showcomponent
```

Component	Status	Pending	POST	Description
/N0/SB0/P0	disabled	-	chs	UltraSPARC-IV, 1050MHz, 16M ECache
/N0/SB0/P1	disabled	-	chs	UltraSPARC-IV, 1050MHz, 16M ECache
/N0/SB0/P2	disabled	-	chs	UltraSPARC-IV, 1050MHz, 16M ECache
/N0/SB0/P3	disabled	-	chs	UltraSPARC-IV, 1050MHz, 16M ECache
/N0/SB0/P0/B0/L0	disabled	-	chs	empty
/N0/SB0/P0/B0/L2	disabled	-	chs	empty
/N0/SB0/P0/B1/L1	disabled	-	chs	2048M DRAM
/N0/SB0/P0/B1/L3	disabled	-	chs	2048M DRAM
.				
.				
.				
/N0/SB0/P3/B0/L0	disabled	-	chs	empty
/N0/SB0/P3/B0/L2	disabled	-	chs	empty
/N0/SB0/P3/B1/L1	disabled	-	chs	1024M DRAM
/N0/SB0/P3/B1/L3	disabled	-	chs	1024M DRAM
/N0/SB4/P0	enabled	-	pass	UltraSPARC-IV, 1050MHz, 16M ECache

CODE EXAMPLE 7-7 showcomponent Command Output – Disabled Components (*Continued*)

/N0/SB4/P1	enabled	-	pass	UltraSPARC-IV, 1050MHz, 16M ECache
/N0/SB4/P2	enabled	-	pass	UltraSPARC-IV, 1050MHz, 16M ECache
/N0/SB4/P3	enabled	-	pass	UltraSPARC-IV, 1050MHz, 16M ECache
.				
.				
.				

Reviewing Additional Error Information

For systems configured with enhanced-memory SCs (SC V2s), the `showerrorbuffer -p` command shows the system error contents maintained in the persistent buffer.

However, for systems that do not have enhanced-memory SCs, the `showerrorbuffer` command shows the contents of the dynamic buffer and displays error messages that otherwise might be lost when your domains are rebooted as part of the domain recovery process.

In either case, the information displayed can be used by your service provider for troubleshooting purposes.

CODE EXAMPLE 7-8 shows the output displayed for a domain hardware error.

CODE EXAMPLE 7-8 showerrorbuffer Command output – Hardware Error

```
EX07:
lom>showerrorbuffer
ErrorData[0]
  Date: Fri Jan 30 10:23:32 EST 2004
  Device: /SSC1/sbbc0/systemepld
  Register: FirstError[0x10] : 0x0200
           SB0 encountered the first error
ErrorData[1]
  Date: Fri Jan 30 10:23:32 EST 2004
  Device: /SB0/bbcGroup0/repeaterepld
  Register: FirstError[0x10]: 0x0002
           sdc0 encountered the first error
ErrorData[2]
  Date: Fri Jan 30 10:23:32 EST 2004
  Device: /SB0/sdc0
  ErrorID: 0x60171010
  Register: SafariPortError0[0x200] : 0x00000002
           ParSglErr [01:01] : 0x1 ParitySingle error
```

Troubleshooting

This chapter provides troubleshooting information for a system administrator. The chapter describes the following topics:

- “System Faults” on page 80
 - “Displaying Diagnostic Information” on page 90
 - “Assisting Sun Service Personnel in Determining Causes of Failure” on page 91
 - “Recovering a Hung System” on page 85
-

Device Mapping

The physical address represents a physical characteristic that is unique to the device. Examples of physical addresses include the bus address and the slot number. The slot number indicates where the device is installed.

You reference a physical device by the node identifier—Agent ID (AID). The AID ranges from 0 to 31 in decimal notation (0 to 1f in hexadecimal). In the device path beginning with `ssm@0,0` the first number, 0, is the node ID.

CPU/Memory Mapping

CPU/Memory board and memory agent IDs (AIDs) range from 0 to 23 in decimal notation (0 to 17 in hexadecimal). The system can have up to three CPU/Memory boards.

Each CPU/Memory board has four CPUs, depending on your configuration. Each CPU/Memory board has up to four banks of memory. Each bank of memory is controlled by one memory management unit (MMU), which is the CPU. The following code example shows a device tree entry for a CPU and its associated memory:

```
/ssm@0,0/SUNW/UltraSPARC-III@b,0 /ssm@0,0/SUNW/memory-controller@b,400000
```

where:

in b, 0

- b is the CPU agent identifier (AID)
- 0 is the CPU register

in b, 400000

- b is the memory agent identifier (AID)
- 400000 is the memory controller register

There are up to four CPUs on each CPU/Memory board (TABLE 8-1):

- CPUs with agent IDs 0–3 reside on board name SB0
- CPUs with agent IDs 8–11 on board name SB2, and so on.

TABLE 8-1 CPU and Memory Agent ID Assignment

CPU/Memory Board Name	Agent IDs On Each CPU/Memory Board			
	CPU 0	CPU 1	CPU 2	CPU 3
SB0	0 (0)	1 (1)	2 (2)	3 (3)
SB2	8 (8)	9 (9)	10 (a)	11 (b)
SB4	16 (10)	17 (11)	18 (12)	19 (13)

The first number in the columns of agent IDs is a decimal number. The number or letter in parentheses is in hexadecimal notation.

IB_SSC Assembly Mapping

TABLE 8-2 lists the types of I/O assembly, the number of slots each I/O assembly has, and the systems the I/O assembly types are supported on.

TABLE 8-2 I/O Assembly Type and Number of Slots

I/O Assembly Type	Number of Slots Per I/O Assembly
PCI	6

TABLE 8-3 lists the number of I/O assemblies per system and the I/O assembly name.

TABLE 8-3 Number and Name of I/O Assemblies per System

Number of I/O Assemblies	I/O Assembly Name
1	IB6

Each I/O assembly hosts two I/O controllers:

- I/O controller 0
- I/O controller 1

When mapping the I/O device tree entry to a physical component in the system, you must consider up to five nodes in the device tree:

- Node identifier (ID)
- I/O controller agent ID (AID)
- Bus offset
- PCI slot
- Device instance

TABLE 8-4 lists the AIDs for the two I/O controllers in each I/O assembly.

TABLE 8-4 I/O Controller Agent ID Assignments

Slot Number	I/O Assembly Name	Even I/O controller AID	Odd I/O Controller AID
6	IB6	24 (18)	25 (19)

The first number in the column is a decimal number. The number (or a number and letter combination) in parentheses is in hexadecimal notation.

The I/O controller has two bus sides: A and B.

- Bus A, which is 66 MHz, is referenced by offset 600000.
- Bus B, which is 33 MHz, is referenced by offset 700000.

The board slots located in the I/O assembly are referenced by the device number.

This section describes the PCI I/O assembly slot assignments and provides an example of the device path.

The following code example gives a breakdown of a device tree entry for a SCSI disk:

```
/ssm@0,0/pci@19,700000/pci@3/SUNW,ispw@4/sd@5,0
```

Note – The numbers in the device path are hexadecimal.

where:

in 19,700000

- 19 is the I/O controller agent identifier (AID)
- 700000 is the bus offset

in pci@3

- 3 is the device number

isptwo is the SCSI host adapter

in sd@5,0

- 5 is the SCSI target number for the disk
- 0 is the logic unit number (LUN) of the target disk

This section describes the PCI I/O assembly slot assignments and provides an example of the device path.

TABLE 8-5 lists, in hexadecimal notation, the slot number, I/O assembly name, device path of each I/O assembly, the I/O controller number, and the bus.

TABLE 8-5 IB_SSC Assembly PCI Device Mapping

I/O Assembly Name	Device Path	Physical Slot Number	I/O Controller Number	Bus
IB6	/ssm@0,0/pci@18,700000/*@1	0	0	B
	/ssm@0,0/pci@18,700000/*@2	1	0	B
	/ssm@0,0/pci@18,700000/*@3	x	0	B
	/ssm@0,0/pci@18,600000/*@1	5	0	A
	/ssm@0,0/pci@18,600000/*@2	w	0	A
	/ssm@0,0/pci@19,700000/*@1	2	1	B
	/ssm@0,0/pci@19,700000/*@2	3	1	B
	/ssm@0,0/pci@19,700000/*@3	4	1	B
	/ssm@0,0/pci@19,600000/*@1	y	1	A
	/ssm@0,0/pci@19,600000/*@2	z	1	A

where:

w = onboard LSI1010R SCSI controller

x = onboard CMD646U2 EIDE controller

y = onboard Gigaswift Ethernet controller 0

z = onboard Gigaswift Ethernet controller 1

and * is dependent upon the type of PCI card installed in the slot.

Note the following:

- 600000 is the bus offset and indicates bus A, which operates at 66 MHz.
- 700000 is the bus offset and indicates bus B, which operates at 33 MHz.
- *@3 is the device number. In this example @3 means it is the third device on the bus.

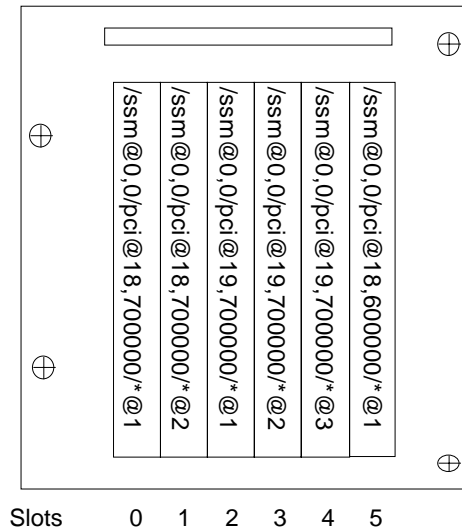

FIGURE 8-1 Sun Fire entry-level midrange systems IB_SSC PCI Physical Slot Designations for IB6

where * is dependent upon the type of PCI card installed in the slot.

For instance:

- Dual Differential Ultra SCSI card (375-0006) in Slot 4
- FC-AL card (375-3019) in Slot 3
- FC-AL card (375-3019) in Slot 2

would generate device paths as follows:

```
/ssm@0,0/pci@19,700000/scsi@3,1
/ssm@0,0/pci@19,700000/scsi@3,1 (scsi-2)
/ssm@0,0/pci@19,700000/scsi@3,1/tape (byte)
/ssm@0,0/pci@19,700000/scsi@3,1/disk (block)
/ssm@0,0/pci@19,700000/scsi@3 (scsi-2)
/ssm@0,0/pci@19,700000/scsi@3/tape (byte)
/ssm@0,0/pci@19,700000/scsi@3/disk (block)

/ssm@0,0/pci@19,700000/SUNW,qlc@2 (scsi-fcp)
/ssm@0,0/pci@19,700000/SUNW,qlc@2/fp@0,0 (fp)
/ssm@0,0/pci@19,700000/SUNW,qlc@2/fp@0,0/disk (block)

/ssm@0,0/pci@19,700000/SUNW,qlc@1 (scsi-fcp)
/ssm@0,0/pci@19,700000/SUNW,qlc@1/fp@0,0 (fp)
/ssm@0,0/pci@19,700000/SUNW,qlc@1/fp@0,0/disk (block)
```

System Faults

A system fault is any condition that is considered to be unacceptable for normal system operation. When the system has a fault, the Fault LED () will turn on. The system indicators are shown in FIGURE 8-2.

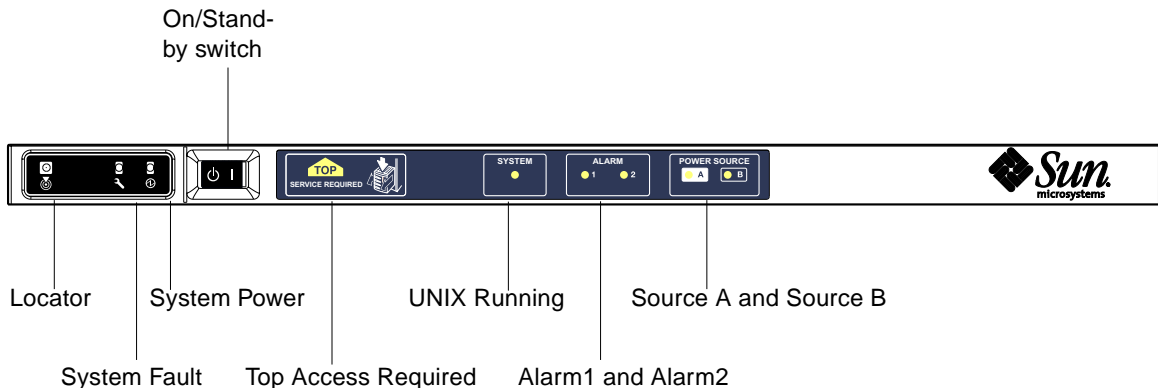

FIGURE 8-2 System Indicators

The indicator states are shown in TABLE 8-6. You must take immediate action to eliminate a system fault.

TABLE 8-6 System Fault Indicator States

FRU name	Fault indicator lit when fault detected*	System Fault indicator lit on FRU fault*	Top Access lit on FRU fault ¹	Comments
System Board	Yes	Yes	Yes	Includes processors, Ecache and DIMMs
Level 2 repeater	Yes	Yes	Yes	
IB_SSC	Yes	Yes	Yes	
System Controller	No	Yes	Yes	IB_SSC fault LED lit
Fan	Yes	Yes	Yes	IB Fan fault LED lit
Power Supply	Yes (by hardware)	Yes	No	All power supply indicators are lit by the power supply hardware. There is also a predicted fault indicator. Power supply EEPROM errors do not cause degraded state as there is no indicator control.
Power distribution board	No	Yes	Yes	Can only be degraded.
Baseplane	No	Yes	Yes	Can only be degraded.
System indicator board	No	Yes	Yes	Can only be degraded.
System configuration card	No	Yes	No	
Fan tray	Yes	Yes	No	
Main fan	Yes	Yes	No	
Media bay	No	Yes	Yes	
Disk	Yes	Yes	No	

* This includes faults where the FRU is only degraded.

¹ If lit, indicates the failing FRU is accessed from the top of the platform. It is important that you employ the anti-tip legs on the cabinet before extending the platform out on its rails.

Customer Replaceable Units

Sun Fire E2900

The following FRUs are considered to be ones on which you can deal with faults:

- Hard disks – hot swappable
- PSUs (PS0/PS1/PS2/PS3) – hot swappable

- CPU/Memory Boards (SB0/SB2/SB4) – can be blacklisted if considered faulty
- Repeater Boards (RP0/RP2) – can be blacklisted if considered faulty

If a fault is indicated on any other FRU or a physical replacement of blacklisted FRUs above is required, then SunService should be called.

Sun Fire V1280

The following FRUs are considered to be ones on which you can deal with faults:

- Hard disks – hot swappable
- PSUs (PS0/PS1/PS2/PS3) – hot swappable
- CPU/Memory Boards (SB0/SB2/SB4) – can be blacklisted if considered faulty
- Repeater Boards (RP0/RP2) – can be blacklisted if considered faulty

If a fault is indicated on any other FRU or a physical replacement of blacklisted FRUs above is required, then SunService should be called.

Netra 1280

The following FRUs are considered to be ones on which you can deal with faults:

- Hard disks – hot swappable
- PSUs (PS0/PS1/PS2/PS3) – hot swappable

Note – Only suitably trained personnel or SunService are permitted to enter the Restricted Access Location to hotswap PSUs or hard disk drives.

- CPU/Memory Boards (SB0/SB2/SB4) – can be blacklisted if considered faulty
- Repeater Boards (RP0/RP2) – can be blacklisted if considered faulty

If a fault is indicated on any other FRU or a physical replacement of blacklisted FRUs above is required, then SunService should be called.

Manual Blacklisting (while waiting for repair)

The System Controller supports the blacklisting feature, which allows you to disable components on a board (TABLE 8-7).

Blacklisting provides a list of system board components that will not be tested and will not be configured into the Solaris operating environment. The blacklist is stored in nonvolatile memory.

TABLE 8-7 Blacklisting Component Names

System Component	Component Subsystem	Component Name
CPU system		<i>slot/port/physical_bank/logical_bank</i>
	CPU/Memory boards (<i>slot</i>)	SB0, SB2, SB4
	Ports on the CPU/Memory board	P0, P1, P2, P3
	Physical memory banks on CPU/Memory boards	B0, B1
I/O assembly system	Logical banks on CPU/Memory boards	L0, L1, L2, L3
		<i>slot/port/bus</i> or <i>slot/card</i>
	I/O assembly	IB6
	Ports on the I/O assembly	P0, P1
Repeater system	Buses on the I/O assembly	B0, B1
	I/O cards in the I/O assemblies	C0, C1, C2, C3, C4, C5
		< <i>slot</i> >
	Repeater board	RP0, RP2

Blacklist a component or device if you believe it might be failing intermittently or is failing. Troubleshoot a device you believe is having problems.

There are two system controller commands for blacklisting:

- `setls`
- `showcomponent`

Note – The `enablecomponent` and `disablecomponent` commands have been replaced by the `setls` command. These commands were formerly used to manage component resources. While the `enablecomponent` and `disablecomponent` commands are still available, it is suggested that you use the `setls` command to control the configuration of components into or out of the system.

The `setls` command only updates the blacklist. It does not directly affect the state of the currently configured system boards.

The updated lists will take effect when you do one the following:

- Reboot the system.
- Use dynamic reconfiguration to configure the board containing the blacklisted component out of and then back into the system.

In order to use `setls` on the Repeater Boards (RP0/RP2) the system first has to be shut down to Standby using the `poweroff` command.

When the `setls` command is issued for a Repeater Board (RP0/RP2), the System Controller will be automatically reset to make use of the new settings.

If a replacement Repeater Board is inserted, it is necessary to manually reset the System Controller using the `resetsc` command. Refer to the *Sun Fire Entry-Level Midrange System Controller Command Reference Manual* for a description of this command.

Special Considerations for CPU/Memory Boards

In the unlikely event that a CPU/Memory board fails the interconnect test during POST, a message similar to the following will appear in POST output:

```
Jul 15 15:58:12 noname lom: SB0/ar0 Bit in error P3_ADDR [2]
Jul 15 15:58:12 noname lom: SB0/ar0 Bit in error P3_ADDR [1]
Jul 15 15:58:12 noname lom: SB0/ar0 Bit in error P3_ADDR [0]
Jul 15 15:58:12 noname lom: AR Interconnect test: System board SB0/ar0 address
repeater connections to system board RP2/ar0 failed
Jul 15 15:58:13 noname lom: SB0/ar0 Bit in error P3_INCOMING [0]
Jul 15 15:58:17 noname lom: SB0/ar0 Bit in error P3_PREREQ [0]
Jul 15 15:58:17 noname lom: SB0/ar0 Bit in error P3_ADDR [18]
Jul 15 15:58:17 noname lom: SB0/ar0 Bit in error P3_ADDR [17]
```

A CPU/Memory board failing the interconnect test may prevent the `poweron` command from completely powering up the system. The system will then drop back to the `lom>` prompt.

As a provisional measure, before Service intervention is obtained, the faulty CPU/Memory board can be isolated from the system using the following sequence of commands at the System Controller `lom>` prompt:

```
lom>disablecomponent SBx
.
.
lom>poweroff
.
.
lom>resetsc -y
```

A subsequent `poweron` command should now be successful.

Recovering a Hung System

If you cannot log into the Solaris operating environment, and typing the `break` command from the LOM shell did not force control of the system back to the OpenBoot PROM `ok` prompt, then the system has stopped responding.

In some circumstances the host watchdog will detect that the Solaris operating environment has stopped responding and will automatically reset the system.

Assuming that the host watchdog has not been disabled (using the `setupsc` command) then the Host Watchdog will cause an automatic reset of the system.

Also, you can issue the `reset` command (default option is `-x` which causes an XIR to be sent to the processors) from the `lom>` prompt. The `reset` command causes the Solaris operating environment to be terminated.



Caution – When the Solaris operating environment is terminated, data in memory might not be flushed to disk. This could cause a loss or corruption of the application file system data. Before the Solaris operating environment is terminated, this action requires confirmation from you.

▼ To Recover a Hung System Manually

1. Complete the steps in “Assisting Sun Service Personnel in Determining Causes of Failure” on page 91.
2. Access the LOM shell.
See Chapter 3.

3. Type the `reset` command to force control of the system back to the OpenBoot PROM. The `reset` command sends an externally initiated reset (XIR) to the system and collects data for debugging the hardware.

```
lom>reset
```

Note – An error is displayed if the `setsecure` command has been used to set the system into secure mode. You cannot use the `reset` or `break` commands while the system is in secure mode. Refer to the *Sun Fire Entry-Level Midrange System Controller Command Reference Manual* for more details.

4. This step depends on the setting of the Open Boot PROM `error-reset-recovery` configuration variable.

- If the `error-reset-recovery` configuration variable is set to `none`, the system returns immediately to the OpenBoot PROM. When the OpenBoot PROM takes control, it takes actions based on the setting of the OpenBoot PROM `error-reset-recovery` configuration variable. You can type any OpenBoot PROM command from the `ok` prompt, including rebooting the Solaris operating environment with the `boot` command. Also, you can force a core file with the `sync` command. The actions that can be configured by this variable might mean that the system will not return to the `ok` prompt.
- If the `error-reset-recovery` configuration variable is *not* set to `none`, the OpenBoot PROM will automatically take recovery actions.
- If the `error-reset-recovery` configuration variable is set to `sync` (default), the system generates a Solaris operating environment core file and reboots the system.
- If the OpenBoot PROM `error-reset-recovery` configuration variable is set to `boot`, the system is rebooted.

5. If the previous actions fail to reboot the system, use the `poweroff` and `poweron` commands to power cycle the system.

To power off the system, type:

```
lom>poweroff
```

To power on the system, type:

```
lom>poweron
```

Moving System Identity

You may decide that the simplest way to restore service in some circumstances is to use a complete replacement system. In order to facilitate the rapid transfer of system identity and critical settings from one system to its replacement, the System Configuration Card (SCC) can be physically removed from the SCC Reader (SCCR) of the faulty system and inserted into the SCCR of the replacement system.

The following information is stored on the System Configuration Card (SCC):

- MAC addresses
 - System Controller 10/100 Ethernet Port
 - Onboard Gigabit Ethernet port NET0
 - Onboard Gigabit Ethernet port NET1
- Hostid
- Critical LOM configurations
 - LOM password
 - escape sequence
 - SC network settings (IP address / DHCP / gateway etc.)
 - eventreporting level
 - host watchdog enabled/disabled
 - On/Standby enabled/disabled
 - secure mode enabled/disabled
- Critical OBP configurations
 - auto-boot?
 - boot-device
 - diag-device
 - use-nvramrc?
 - local-mac-address?

Temperature

One indication of problems may be overtemperature of one or more components. Use the `showenvironment` command to list current status.

TABLE 8-8 Checking Temperature Conditions Using the `showenvironment` Command

```
lom>showenviroment
```

Slot	Device	Sensor	Value	Units	Age	Status
SSC1	SBBC 0	Temp. 0	34	Degrees C	1 sec	OK
SSC1	CBH 0	Temp. 0	41	Degrees C	1 sec	OK
SSC1	Board 0	Temp. 0	22	Degrees C	1 sec	OK

TABLE 8-8 Checking Temperature Conditions Using the showenvironment Command (Continued)

SSC1 Board 0	Temp. 1	22	Degrees C	1 sec	OK
SSC1 Board 0	Temp. 2	28	Degrees C	1 sec	OK
SSC1 Board 0	1.5 VDC 0	1.49	Volts DC	1 sec	OK
SSC1 Board 0	3.3 VDC 0	3.35	Volts DC	1 sec	OK
SSC1 Board 0	5 VDC 0	4.98	Volts DC	1 sec	OK
/N0/PS0 Input 0	Volt. 0	- -		1 sec	OK
/N0/PS0 48 VDC 0	Volt. 0	48.00	Volts DC	1 sec	OK
/N0/PS1 Input 0	Volt. 0	- -		5 sec	OK
/N0/PS1 48 VDC 0	Volt. 0	48.00	Volts DC	5 sec	OK
/N0/FT0 Fan 0	Cooling 0	Auto		5 sec	OK
/N0/FT0 Fan 1	Cooling 0	Auto		5 sec	OK
/N0/FT0 Fan 2	Cooling 0	Auto		5 sec	OK
/N0/FT0 Fan 3	Cooling 0	Auto		5 sec	OK
/N0/FT0 Fan 4	Cooling 0	Auto		5 sec	OK
/N0/FT0 Fan 5	Cooling 0	Auto		5 sec	OK
/N0/FT0 Fan 6	Cooling 0	Auto		5 sec	OK
/N0/FT0 Fan 7	Cooling 0	Auto		5 sec	OK
/N0/RP0 Board 0	1.5 VDC 0	1.49	Volts DC	5 sec	OK
/N0/RP0 Board 0	3.3 VDC 0	3.37	Volts DC	5 sec	OK
/N0/RP0 Board 0	Temp. 0	20	Degrees C	5 sec	OK
/N0/RP0 Board 0	Temp. 1	19	Degrees C	5 sec	OK
/N0/RP0 SDC 0	Temp. 0	55	Degrees C	5 sec	OK
/N0/RP0 AR 0	Temp. 0	45	Degrees C	5 sec	OK
/N0/RP0 DX 0	Temp. 0	57	Degrees C	5 sec	OK
/N0/RP0 DX 1	Temp. 0	59	Degrees C	5 sec	OK
/N0/RP2 Board 0	1.5 VDC 0	1.48	Volts DC	5 sec	OK
/N0/RP2 Board 0	3.3 VDC 0	3.37	Volts DC	5 sec	OK
/N0/RP2 Board 0	Temp. 0	22	Degrees C	5 sec	OK
/N0/RP2 Board 0	Temp. 1	22	Degrees C	5 sec	OK
/N0/RP2 SDC 0	Temp. 0	53	Degrees C	5 sec	OK
/N0/RP2 AR 0	Temp. 0	43	Degrees C	5 sec	OK
/N0/RP2 DX 0	Temp. 0	49	Degrees C	5 sec	OK
/N0/RP2 DX 1	Temp. 0	52	Degrees C	5 sec	OK
/N0/SB0 Board 0	1.5 VDC 0	1.51	Volts DC	5 sec	OK
/N0/SB0 Board 0	3.3 VDC 0	3.29	Volts DC	5 sec	OK
/N0/SB0 SDC 0	Temp. 0	46	Degrees C	5 sec	OK
/N0/SB0 AR 0	Temp. 0	39	Degrees C	5 sec	OK
/N0/SB0 DX 0	Temp. 0	45	Degrees C	5 sec	OK
/N0/SB0 DX 1	Temp. 0	49	Degrees C	5 sec	OK
/N0/SB0 DX 2	Temp. 0	53	Degrees C	5 sec	OK
/N0/SB0 DX 3	Temp. 0	48	Degrees C	5 sec	OK
/N0/SB0 SBBC 0	Temp. 0	49	Degrees C	5 sec	OK
/N0/SB0 Board 1	Temp. 0	24	Degrees C	5 sec	OK
/N0/SB0 Board 1	Temp. 1	24	Degrees C	6 sec	OK
/N0/SB0 CPU 0	Temp. 0	47	Degrees C	6 sec	OK
/N0/SB0 CPU 0	1.8 VDC 0	1.72	Volts DC	6 sec	OK
/N0/SB0 CPU 1	Temp. 0	47	Degrees C	6 sec	OK

TABLE 8-8 Checking Temperature Conditions Using the `showenvironment` Command (Continued)

/N0/SB0 CPU 1	1.8 VDC 1	1.72	Volts DC	6 sec	OK
/N0/SB0 SBBC 1	Temp. 0	37	Degrees C	6 sec	OK
/N0/SB0 Board 1	Temp. 2	24	Degrees C	6 sec	OK
/N0/SB0 Board 1	Temp. 3	24	Degrees C	6 sec	OK
/N0/SB0 CPU 2	Temp. 0	49	Degrees C	6 sec	OK
/N0/SB0 CPU 2	1.8 VDC 0	1.71	Volts DC	6 sec	OK
/N0/SB0 CPU 3	Temp. 0	46	Degrees C	6 sec	OK
/N0/SB0 CPU 3	1.8 VDC 1	1.72	Volts DC	7 sec	OK
/N0/SB2 Board 0	1.5 VDC 0	1.51	Volts DC	6 sec	OK
/N0/SB2 Board 0	3.3 VDC 0	3.29	Volts DC	6 sec	OK
/N0/SB2 SDC 0	Temp. 0	55	Degrees C	6 sec	OK
/N0/SB2 AR 0	Temp. 0	37	Degrees C	6 sec	OK
/N0/SB2 DX 0	Temp. 0	47	Degrees C	6 sec	OK
/N0/SB2 DX 1	Temp. 0	50	Degrees C	6 sec	OK
/N0/SB2 DX 2	Temp. 0	53	Degrees C	6 sec	OK
/N0/SB2 DX 3	Temp. 0	47	Degrees C	6 sec	OK
/N0/SB2 SBBC 0	Temp. 0	48	Degrees C	6 sec	OK
/N0/SB2 Board 1	Temp. 0	23	Degrees C	7 sec	OK
/N0/SB2 Board 1	Temp. 1	24	Degrees C	7 sec	OK
/N0/SB2 CPU 0	Temp. 0	45	Degrees C	7 sec	OK
/N0/SB2 CPU 0	1.8 VDC 0	1.72	Volts DC	7 sec	OK
/N0/SB2 CPU 1	Temp. 0	46	Degrees C	7 sec	OK
/N0/SB2 CPU 1	1.8 VDC 1	1.73	Volts DC	7 sec	OK
/N0/SB2 SBBC 1	Temp. 0	37	Degrees C	7 sec	OK
/N0/SB2 Board 1	Temp. 2	24	Degrees C	7 sec	OK
/N0/SB2 Board 1	Temp. 3	25	Degrees C	7 sec	OK
/N0/SB2 CPU 2	Temp. 0	47	Degrees C	7 sec	OK
/N0/SB2 CPU 2	1.8 VDC 0	1.71	Volts DC	7 sec	OK
/N0/SB2 CPU 3	Temp. 0	45	Degrees C	7 sec	OK
/N0/SB2 CPU 3	1.8 VDC 1	1.71	Volts DC	7 sec	OK
/N0/IB6 Board 0	1.5 VDC 0	1.50	Volts DC	7 sec	OK
/N0/IB6 Board 0	3.3 VDC 0	3.35	Volts DC	7 sec	OK
/N0/IB6 Board 0	5 VDC 0	4.95	Volts DC	7 sec	OK
/N0/IB6 Board 0	12 VDC 0	11.95	Volts DC	7 sec	OK
/N0/IB6 Board 0	Temp. 0	29	Degrees C	7 sec	OK
/N0/IB6 Board 0	Temp. 1	28	Degrees C	7 sec	OK
/N0/IB6 Board 0	3.3 VDC 1	3.30	Volts DC	7 sec	OK
/N0/IB6 Board 0	3.3 VDC 2	3.28	Volts DC	7 sec	OK
/N0/IB6 Board 0	1.8 VDC 0	1.81	Volts DC	7 sec	OK
/N0/IB6 Board 0	2.5 VDC 0	2.51	Volts DC	7 sec	OK
/N0/IB6 Fan 0	Cooling 0	High		7 sec	OK
/N0/IB6 Fan 1	Cooling 0	High		7 sec	OK
/N0/IB6 SDC 0	Temp. 0	63	Degrees C	7 sec	OK
/N0/IB6 AR 0	Temp. 0	77	Degrees C	7 sec	OK
/N0/IB6 DX 0	Temp. 0	69	Degrees C	7 sec	OK
/N0/IB6 DX 1	Temp. 0	73	Degrees C	8 sec	OK

TABLE 8-8 Checking Temperature Conditions Using the `showenvironment` Command (Continued)

/N0/IB6	SBBC	0	Temp.	0	51	Degrees C	8 sec	OK
/N0/IB6	IOASIC	0	Temp.	0	46	Degrees C	8 sec	OK
/N0/IB6	IOASIC	1	Temp.	1	52	Degrees C	8 sec	OK

Power Supplies

Each power supply unit (PSU) has its own LEDs as follows:

- Power/Active – lit if PSU is supplying main power; blinks if PSU is in Standby mode
- Faulty – lit if PSU has detected a fault condition and has turned off its main output
- Predictive Fail – lit if PSU has detected a pending internal fault but is still providing main output power (degraded PSU fan speed is the only trigger for this condition).

In addition there are two System LEDs labelled SourceA and SourceB. These show the state of the power feeds to the system. There are four physical power feeds and they are split into A and B.

Feed A supplies PS0 and PS1, feed B supplies PS2 and PS3. If either PS0 or PS1 receives input power then the SourceA indicator is lit. If either PS2 or PS3 receives input power then the SourceB indicator is lit. If neither of the supplies receives input power, the indicator is turned off.

These indicators are set on the basis of periodic monitoring at least once every 10 seconds.

Displaying Diagnostic Information

For information on displaying diagnostic information, refer to the *Sun Hardware Platform Guide*, which is available with your Solaris operating environment release.

Assisting Sun Service Personnel in Determining Causes of Failure

Provide the following information to Sun service personnel so that they can help you determine the causes of your failure:

- A verbatim transcript of all output written to the system console leading up to the failure. Also include any output printed subsequent to user actions. If the transcript does not show certain user actions, in a separate file include comments on what actions prompted particular messages.
- A copy of the system log file from `/var/adm/messages` from the time leading up to the failure.
- The following system controller command output from the LOM shell:
 - `showsc -v` command
 - `showboards -v` command
 - `showlogs` command
 - `history`
 - `date`
 - `showresetstate`
 - `showenvironment`

Firmware Upgrade Procedures

This chapter explains how to upgrade the system firmware.

The firmware on the Sun Fire entry-level midrange systems system can be updated by two mechanisms:

- The `flashupdate` command from the System Controller LOM prompt.
- The `lom -G` command in the Solaris operating environment.

The first method requires that the 10/100 System Controller Ethernet port is connected to a suitable network and is configured so that it can see an external FTP or HTTP server which contains the new firmware images to be downloaded.

Using the `flashupdate` Command

The `flashupdate` command requires that the 10/100 Ethernet port can access an external FTP or HTTP server.

The `flashupdate` command updates the flash PROMs in the System Controller and the system boards (CPU/Memory boards and I/O assembly). The source flash image is normally held on an NFS server. In the case of CPU/Memory boards you can update one board with the flash image from another.

The syntax for the `flashupdate` command is:

```
flashupdate [-y|-n] -f <url> all|systemboards|scapp|rtos|<board> . . .
flashupdate [-y|-n] -c <source_board> <destination_board> . . .
flashupdate [-y|-n] -u
```

where:

`-y` does not prompt for confirmation.

-n does not execute this command if confirmation is required.

-f specifies a URL as the source of the flash images. This option requires a network connection with the flash image held on an NFS server. Use this option to install new firmware.

<url> is the URL of the directory containing the flash images and must be of the form:

ftp://[*<userid>*:*<password>*@]*<hostname>*/*<path>*

or

http://*<hostname>*/*<path>*

all causes all boards (CPU/Memory, I/O Assembly and System Controller) to be updated. This action reboots the System Controller.

systemboards causes all CPU/Memory boards and the I/O Assembly to be updated.

scapp causes the System Controller application to be updated. This action reboots the System Controller.

rtos causes the System Controller real time operating system to be updated. This action reboots the System Controller.

<board> names a specific board to be updated (sb0, sb2, sb4 or ib6).

-c specifies a board as the source of flash images. Use this option to update replacement CPU/Memory boards.

<source_board> is a pre-existing CPU/Memory board to be used as the source of the flash image (sb0, sb2 or sb4).

<destination_board> is the CPU/Memory board to be updated (sb0, sb2 or sb4).

-u automatically updates all CPU/Memory boards with the image from the board which currently has the highest firmware revision. Use this option to update replacement CPU/Memory boards.

-h displays help for this command.

A power cycle is required in order to activate the updated OpenBoot PROM.

Note – flashupdate cannot retrieve flash images from a secure (userid/password) protected HTTP URL. A message of the form flashupdate: failed, URL does not contain required file: *<file>* will be returned, although the file may exist.



Caution – Do not interrupt the `flashupdate` operation. If the `flashupdate` command is terminated abnormally, the System Controller will go into single use mode and will only be accessible from the serial port.



Caution – Before performing a `flashupdate`, check the firmware revisions of all boards using the `showboards -p version` command.



Caution – If the System Controller application (`scapp`) or real time operating system (`rtos`) are to be updated, you are strongly recommended to run the `flashupdate` command from a LOM shell running on the serial connection so that the results can be fully monitored.



Caution – Before updating CPU/Memory boards or the I/O Assembly, ensure that all boards to be updated are powered on by using the `poweron` command.

▼ To Upgrade a Sun Fire V1280 or Netra 1280 System Running Firmware Version 5.13.x to 5.17.0 Using the `flashupdate` Command

1. Upgrade the firmware on the SC:

```
lom>flashupdate -f <URL> scapp rtos
```

2. Power on all boards:

```
lom>poweron all
```

3. Upgrade the firmware on the system boards:

```
lom>flashupdate -f <URL> sb0 sb2 sb4 ib6
```

This step has brought `sb2`, `sb4`, and `IB6` up to the same firmware level as board `sb0`.

▼ To Downgrade the Firmware on a Sun Fire V1280 or Netra 1280 System From Firmware Version 5.17.0 to 5.13.x

1. Downgrade the firmware on the SC .
2. Power on all boards.
3. Downgrade the firmware on the other boards.

Using the `lom -G` Command

There are four image types which may need to be transferred using this method with names of the following form:

- `lw8pci.flash` (contains I/O board Local POST)
- `lw8cpu.flash` (contains CPU/Memory Board Local POST and OBP)
- `sgsc.flash` (contains LOM/System Controller firmware)
- `sgrtos.flash` (contains LOM/System Controller Real Time Operating System)

You must place these in a suitable directory, for instance `/var/tmp`, and issue the `lom -G` command with the filename of the file to be downloaded. The firmware knows from header information contained in the file which image type is being upgraded.

These images will be provided in a patch downloadable from www.sunsolve.sun.com or from your SunService representative.

The patch README file should contain full instructions for installing these new firmware images. It is very important that the instructions are followed exactly otherwise you may render your system unbootable.



Caution – Do not interrupt the `lom -G` operation. If the `lom -G` command is terminated abnormally, the System Controller will go into single use mode and will only be accessible from the serial port.



Caution – Before performing a `lom -G`, check the firmware revisions of all boards using the `showboards -p version` command.



Caution – You are strongly recommended to run the `lom -G` command from a Solaris console running on the serial connection so that the results can be fully monitored.



Caution – Before updating CPU/Memory boards or the I/O Assembly, ensure that all boards to be updated are powered on by using the `poweron` command.

Examples

Downloading the lw8pci.flash image:

CODE EXAMPLE 9-1 Downloading the lw8pci.flash Image

```
# lom -G lw8pci.flash
This program will replace LOM firmware with version 5.17.0
Are you sure you want to continue?
Enter 'C' and return to Continue or anything else to Terminate
C
Transferring 346 kB image to the system controller.
This may take several minutes.
.....

Validating image...
346 kB IO image transferred.
Programming /N0/IB6/FP0
Comparing image and flash
# Image and flash are different, proceeding with update.
Erasing      ..... Done
Programming  ..... Done
Verifying    ..... Done
Fri Dec 12 08:20:42 commando lom: /N0/IB6/FP0 updated with version 5.17.0
12/12/2003.
Dec 12 11:20:41 commando-a lw8: /N0/IB6/FP0 updated with version 5.17.0
12/12/2003.

Firmware update complete.

You must reboot Solaris to load the new firmware.
```

Downloading the lw8cpu.flash image:

CODE EXAMPLE 9-2 Downloading the lw8cpu.flash Image

```
# lom -G lw8cpu.flash
This program will replace LOM firmware with version 5.17.0
Are you sure you want to continue?
Enter 'C' and return to Continue or anything else to Terminate
C
Transferring 906 kB image to the system controller.
This may take several minutes.
.....

Validating image...
# 906 kB CPU image transferred.
Programming /N0/SB0/FP0
Comparing image and flash
```

CODE EXAMPLE 9-2 Downloading the lw8cpu.flash Image

```
Image and flash are different, proceeding with update.
Erasing ..... Done
Programming ..... Done
Verifying ..... Done
Fri Dec 12 08:23:43 commando lom: /N0/SB0/FP0 updated with version 5.17.0
12/12/2003.
Dec 12 11:23:42 commando-a lw8: /N0/SB0/FP0 updated with version 5.17.0
12/12/2003.
Programming /N0/SB0/FP1
Comparing image and flash
Image and flash are different, proceeding with update.
Erasing ..... Done
Programming ..... Done
Verifying ..... Done
Fri Dec 12 08:24:24 commando lom: /N0/SB0/FP1 updated with version 5.17.0
12/12/2003.
Dec 12 11:24:23 commando-a lw8: /N0/SB0/FP1 updated with version 5.17.0
12/12/2003.
Programming /N0/SB2/FP0
Comparing image and flash
Image and flash are different, proceeding with update.
Erasing ..... Done
Programming ..... Done
Verifying ..... Done
Fri Dec 12 08:25:06 commando lom: /N0/SB2/FP0 updated with version 5.17.0
12/12/2003.
Dec 12 11:25:06 commando-a lw8: /N0/SB2/FP0 updated with version 5.17.0
12/12/2003.
Programming /N0/SB2/FP1
Comparing image and flash
Image and flash are different, proceeding with update.
Erasing ..... Done
Programming ..... Done
Verifying ..... Done
Fri Dec 12 08:25:48 commando lom: /N0/SB2/FP1 updated with version 5.17.0
12/12/2003.
Dec 12 11:25:48 commando-a lw8: /N0/SB2/FP1 updated with version 5.17.0
12/12/2003.
Programming /N0/SB4/FP0
Comparing image and flash
Image and flash are different, proceeding with update.
Erasing ..... Done
Programming ..... Done
Verifying ..... Done
Fri Dec 12 08:26:31 commando lom: /N0/SB4/FP0 updated with version 5.17.0
12/12/2003.
```

CODE EXAMPLE 9-2 Downloading the lw8cpu.flash Image

```
Dec 12 11:26:30 commando-a lw8: /N0/SB4/FP0 updated with version 5.17.0
12/12/2003.
Programming /N0/SB4/FP1
Comparing image and flash
Image and flash are different, proceeding with update.
Erasing ..... Done
Programming ..... Done
Verifying ..... Done
Fri Dec 12 08:27:11 commando lom: /N0/SB4/FP1 updated with version 5.17.0
12/12/2003.
Dec 12 11:27:10 commando-a lw8: /N0/SB4/FP1 updated with version 5.17.0
12/12/2003.

Firmware update complete.

You must reboot Solaris to load the new firmware.
```

▼ To Upgrade a Sun Fire V1280 or Netra 1280 System Running Firmware Version 5.13.x to 5.17.0 Using the lom -G Command

1. Upgrade the firmware on the SC:

```
# lom -G sgsc.flash
# lom -G sgrtos.flash
```

2. Escape to lom> and reset the SC

```
lom>resetsc -y
```

3. Upgrade the firmware on the system boards:

```
# lom -G lw8cpu.flash
# lom -G lw8pci.flash
lom>shutdown
lom>poweron
```

▼ **To Downgrade the Firmware on a Sun Fire V1280 or Netra 1280 System From Firmware Version 5.17.0 to 5.13.x Using the `lom -G` Command**

- 1. Downgrade the firmware on the SC .**
- 2. Reset the SC.**
- 3. Downgrade the firmware on the other boards.**

CPU/Memory Board Replacement and Dynamic Reconfiguration (DR)

This chapter describes how to dynamically reconfigure the CPU/Memory boards on the Sun Fire entry-level midrange systems system.

Dynamic Reconfiguration

Overview

DR software is part of the Solaris operating environment. With the DR software you can dynamically reconfigure system boards and safely remove them or install them into a system while the Solaris operating environment is running and with minimum disruption to user processes running on the system. You can use DR to do the following:

- Minimize the interruption of system applications while installing or removing a board.
- Disable a failing device by removing it before the failure can crash the operating system.
- Display the operational status of boards.
- Initiate system tests of a board while the system continues to run.

Command Line Interface

The Solaris `cfgadm(1M)` command provides the command line interface for the administration of DR functionality.

DR Concepts

Quiescence

During the unconfigure operation on a system board with permanent memory (OpenBoot PROM or kernel memory), the operating environment is briefly paused, which is known as operating environment quiescence. All operating environment and device activity on the baseplane must cease during a critical phase of the operation.

Note – Quiescence may take several minutes, depending on workload and system configuration.

Before it can achieve quiescence, the operating environment must temporarily suspend all processes, CPUs, and device activities. It may take a few minutes to achieve quiescence depending on system usage and activities currently in progress. If the operating environment cannot achieve quiescence, it displays the reasons, which may include the following:

- An execution thread did not suspend.
- Real-time processes are running.
- A device exists that cannot be paused by the operating environment.

The conditions that cause processes to fail to suspend are generally temporary. Examine the reasons for the failure. If the operating environment encountered a transient condition—a failure to suspend a process—you can try the operation again.

RPC or TCP Time-out or Loss of Connection

Time-outs occur by default after two minutes. Administrators may need to increase this time-out value to avoid time-outs during a DR-induced operating system quiescence, which may take longer than two minutes. Quiescing a system makes the system and related network services unavailable for a period of time that can exceed two minutes. These changes affect both the client and server machines.

Suspend-Safe and Suspend-Unsafe Devices

When DR suspends the operating environment, all of the device drivers that are attached to the operating environment must also be suspended. If a driver cannot be suspended (or subsequently resumed), the DR operation fails.

A *suspend-safe* device does not access memory or interrupt the system while the operating environment is in quiescence. A driver is suspend-safe if it supports operating environment quiescence (suspend/resume). A suspend-safe driver also guarantees that when a suspend request is successfully completed, the device that the driver manages will not attempt to access memory, even if the device is open when the suspend request is made.

A *suspend-unsafe* device allows a memory access or a system interruption to occur while the operating environment is in quiescence.

Attachment Points

An attachment point is a collective term for a board and its slot. DR can display the status of the slot, the board, and the attachment point. The DR definition of a board also includes the devices connected to it, so the term ‘occupant’ refers to the combination of board and attached devices.

- A slot (also called a receptacle) has the ability to electrically isolate the occupant from the host machine. That is, the software can put a single slot into low-power mode.
- Receptacles can be named according to slot numbers or can be anonymous (for example, a SCSI chain). To obtain a list of all available logical attachment points, use the `-l` option with the `cfgadm(1M)` command.

There are two formats used when referring to attachment points:

- A *physical* attachment point describes the software driver and location of the slot. An example of a physical attachment point name is:

```
/devices/ssm@0,0:N0.SBx
```

where `N0` is node 0 (zero),

`SB` is a system board,

`x` is a slot number. A slot number can be 0, 2 or 4 for a system board.

- A *logical* attachment point is an abbreviated name created by the system to refer to the physical attachment point. Logical attachment points take the following form:

```
N0.SBx
```

- Note that `cfgadm` will also show the I/O assembly `N0.IB6`, but as this is non-redundant no DR actions will be allowed on this attachment point.

DR Operations

There are four main types of DR operation.

TABLE 10-1 Types of DR Operation

Connect	The slot provides power to the board and monitors its temperature.
Configure	The operating environment assigns functional roles to a board, and loads device drivers for the board, and brings the devices on that board into use by the Solaris operating environment.
Unconfigure	The system detaches a board logically from the operating environment. Environmental monitoring continues, but devices on the board are not available for system use.
Disconnect	The system stops monitoring the board, and power to the slot is turned off.

If a system board is in use, stop its use and disconnect it from the system before you power it off. After a new or upgraded system board is inserted and powered on, connect its attachment point and configure it for use by the operating environment. The `cfgadm(1M)` command can connect and configure (or unconfigure and disconnect) in a single command, but if necessary, each operation (connection, configuration, unconfiguration, or disconnection) can be performed separately.

Hot-Plug Hardware

Hot-plug devices have special connectors that supply electrical power to the board or module before the data pins make contact. Boards and devices that have hot-plug connectors can be inserted or removed while the system is running. The devices have control circuits to ensure they have a common reference and power control during the insertion process. The interfaces are not powered on until the board is home and the System Controller instructs them to.

The CPU/Memory boards used in the Sun Fire entry-level midrange systems system are hot-plug devices.

Conditions and States

A state is the operational status of either a receptacle (slot) or an occupant (board). A condition is the operational status of an attachment point.

Before you attempt to perform any DR operation on a board or component from a system, you must determine state and condition. Use the `cfgadm(1M)` command with the `-la` options to display the type, state, and condition of each component and the state and condition of each board slot in the system. See the section “Component Types” on page 109 for a list of the component types.

Board States and Conditions

This section contains descriptions of the states and conditions of CPU/Memory boards (also known as system slots).

Board Receptacle States

A board can have one of three receptacle states: empty, disconnected, or connected. Whenever you insert a board, the receptacle state changes from empty to disconnected. Whenever you remove a board the receptacle state changes from disconnected to empty.



Caution – Physically removing a board that is in the connected state, or that is powered on and in the disconnected state, crashes the operating system and can result in permanent damage to that system board.

TABLE 10-2 Board Receptacle States

Name	Description
empty	A board is not present.
disconnected	The board is disconnected from the system bus. A board can be in the disconnected state without being powered off. However, a board must be powered off and in the disconnected state before you remove it from the slot.
connected	The board is powered on and connected to the system bus. You can view the components on a board only after it is in the connected state.

Board Occupant States

A board can have one of two occupant states: configured or unconfigured. The occupant state of a disconnected board is always unconfigured.

TABLE 10-3 Board Occupant States

Name	Description
configured	At least one component on the board is configured.
unconfigured	All of the components on the board are unconfigured.

Board Conditions

A board can be in one of four conditions: unknown, ok, failed, or unusable.

TABLE 10-4 Board Conditions

Name	Description
unknown	The board has not been tested.
ok	The board is operational.
failed	The board failed testing.
unusable	The board slot is unusable.

Component States and Conditions

This section contains descriptions of the states and conditions for components.

Component Receptacle States

A component cannot be individually connected or disconnected. Thus, components can have only one state: connected.

Component Occupant States

A component can have one of two occupant states: configured or unconfigured.

TABLE 10-5 Component Occupant States

Name	Description
configured	Component is available for use by the Solaris operating environment.
unconfigured	Component is not available for use by the Solaris operating environment.

Component Conditions

A component can have one of three conditions: unknown, ok, failed.

TABLE 10-6 Component Conditions

Name	Description
unknown	Component has not been tested.
ok	Component is operational.
failed	Component failed testing.

Component Types

You can use DR to configure or to unconfigure several types of component.

TABLE 10-7 Component Types

Name	Description
cpu	Individual CPU
memory	All the memory on the board

Nonpermanent and Permanent Memory

Before you can delete a board, the environment must vacate the memory on that board. Vacating a board means flushing its nonpermanent memory to swap space and copying its permanent (that is, kernel and OpenBoot PROM memory) to another memory board. To relocate permanent memory, the operating environment on a system must be temporarily suspended, or quiesced. The length of the suspension depends on the system configuration and the running workloads. Detaching a board

with permanent memory is the only time when the operating environment is suspended; therefore, you should know where permanent memory resides so that you can avoid significantly impacting the operation of the system. You can display the permanent memory by using the `cfgadm(1M)` command with the `-v` option. When permanent memory is on the board, the operating environment must find another memory component of adequate size to receive the permanent memory. If that is not possible the DR operation will fail.

Limitations

Memory Interleaving

System boards cannot be dynamically reconfigured if system memory is interleaved across multiple CPU/Memory boards.

Reconfiguring Permanent Memory

When a CPU/Memory board containing non-relocatable (permanent) memory is dynamically reconfigured out of the system, a short pause in all domain activity is required which may delay application response. Typically, this condition applies to one CPU/Memory board in the system. The memory on the board is identified by a non-zero permanent memory size in the status display produced by the `cfgadm -av` command.

DR supports reconfiguration of permanent memory from one system board to another only if one of the following conditions is met:

- The target system board has the same amount of memory as the source system board;

-OR-

- The target system board has more memory than the source system board. In this case, the additional memory is added to the pool of available memory.

Command Line Interface

The following procedures are discussed in this section:

- “To Test a CPU/Memory Board” on page 114
- “To Install a New Board” on page 116
- “To Hot-Swap a CPU/Memory Board” on page 117
- “To Remove a CPU/Memory Board From the System” on page 118
- “To Disconnect a CPU/Memory Board Temporarily” on page 118

Note – There is no need to enable dynamic reconfiguration explicitly. DR is enabled by default.

The `cfgadm` Command

The `cfgadm(1M)` command provides configuration administration operations on dynamically reconfigurable hardware resources. TABLE 10-8 lists the DR board states.

TABLE 10-8 DR Board States from the System Controller (SC)

Board States	Description
Available	The slot is not assigned.
Assigned	The board is assigned, but the hardware has not been configured to use it. The board may be reassigned by the chassis port or released.
Active	The board is being actively used. You cannot reassign an active board.

Displaying Basic Board Status

The `cfgadm` program displays information about boards and slots. Refer to the `cfgadm(1)` man page for options to this command.

Many operations require that you specify the system board names. To obtain these system names, type:

```
# cfgadm
```

When used without options, `cfgadm` displays information about all known attachment points, including board slots and SCSI buses. The following display shows a typical output.

CODE EXAMPLE 10-1 Output of the Basic `cfgadm` Command

```
# cfgadm
Ap_Id Type Receptacle Occupant Condition
N0.IB6 PCI_I/O_Boa connected configured ok
N0.SB0 CPU_Board connected configured unknown
N0.SB4 unknown emptyunconfigured unknown
c0      scsi-bus connected configured unknown
c1      scsi-bus connected unconfigured unknown
c2      scsi-bus connected unconfigured unknown
c3      scsi-bus connected configured unknown
```

Displaying Detailed Board Status

For a more detailed status report, use the command `cfgadm -av`. The `-a` option lists attachment points and the `-v` option turns on expanded (verbose) descriptions.

CODE EXAMPLE 10-2 is a *partial* display produced by the `cfgadm -av` command. The output appears complicated because the lines wrap around in this display. (This status report is for the same system used in CODE EXAMPLE 10-1.) FIGURE 10-1 provides details of each display item.

CODE EXAMPLE 10-2 Output of the `cfgadm -av` Command

```
# cfgadm -av
Ap_Id Receptacle Occupant Condition Information
When Type Busy Phys_Id
N0.IB6 connected configured ok powered-on, assigned
Apr 3 18:04 PCI_I/O_Boa n /devices/ssm@0,0:N0.IB6
N0.IB6::pci0 connected configured ok device
/ssm@0,0/pci@19,70000
Apr 3 18:04 io n /devices/ssm@0,0:N0.IB6::pci0
N0.IB6::pci1 connected configured ok device
/ssm@0,0/pci@19,60000
Apr 3 18:04 io n /devices /ssm@0,0:N0.IB6::pci1
N0.IB6::pci2 connected configured ok device
/ssm@0,0/pci@18,70000
Apr 3 18:04 io n /devices/ssm@0,0:N0.IB6::pci2
N0.IB6::pci3 connected configured ok device
/ssm@0,0/pci@18,60000
Apr 3 18:04 io n /devices/ssm@0,0:N0.IB6::pci3
N0.SB0 connected configured unknown powered-on, assigned
Apr 3 18:04 CPU_Board n /devices/ssm@0,0:N0.SB0
```

CODE EXAMPLE 10-2 Output of the `cfgadm -av` Command (Continued)

```
N0.SB0::cpu0 connected configured ok cpuid 0, speed 750 MHz,
ecache 8 MBytes
Apr 3 18:04 cpu n /devices/ssm@0,0:N0.SB0::cpu0
N0.SB0::cpu1 connected configured ok cpuid 1, speed 750 MHz,
ecache 8 MBytes
Apr 3 18:04 cpu n /devices/ssm@0,0:N0.SB0::cpu1
N0.SB0::cpu2 connected configured ok cpuid 2, speed 750 MHz,
ecache 8 MBytes
Apr 3 18:04 cpu n /devices/ssm@0,0:N0.SB0::cpu2
```

FIGURE 10-1 shows details of the display in CODE EXAMPLE 10-2:

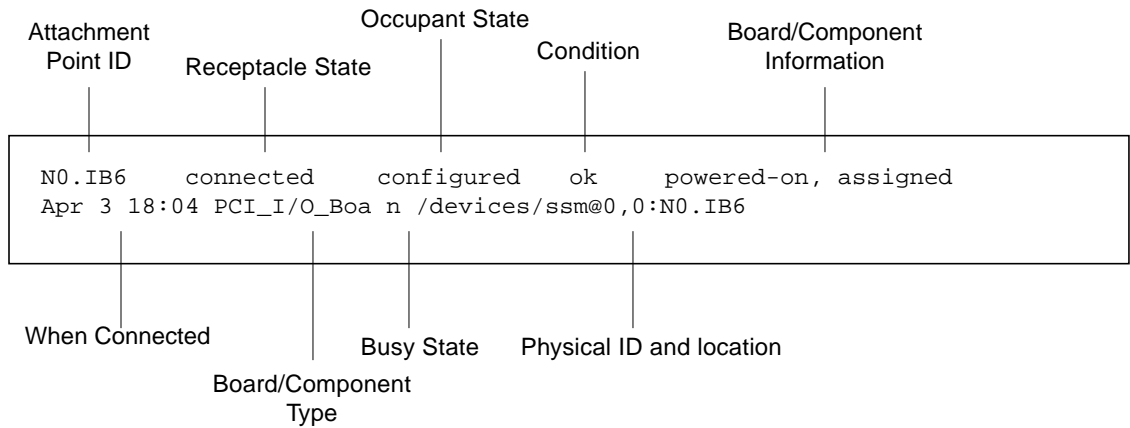

FIGURE 10-1 Details of the Display for `cfgadm -av`

Command Options

The options to the `cfgadm -c` command are listed in TABLE 10-9.

TABLE 10-9 `cfgadm -c` Command Options

cfgadm -c Option	Function
<code>connect</code>	The slot provides power to the board and begins monitoring the board. The slot is assigned if it was not previously assigned.
<code>disconnect</code>	The system stops monitoring the board and power to the slot is turned off.
<code>configure</code>	The operating system assigns functional roles to a board and loads device drivers for the board and for the devices attached to the board.
<code>unconfigure</code>	The system detaches a board logically from the operating system and takes the associated device drivers offline. Environmental monitoring continues, but any devices on the board are not available for system use.

The options provided by the `cfgadm -x` command are listed in TABLE 10-10.

TABLE 10-10 `cfgadm -x` Command Options

cfgadm -x Option	Function
<code>poweron</code>	Powers on a CPU/Memory board.
<code>poweroff</code>	Powers off a CPU/Memory board.

The `cfgadm_sbd` man page provides additional information on the `cfgadm -c` and `cfgadm -x` options. The `sbd` library provides the functionality for hot-plugging system boards of the class `sbd`, through the `cfgadm` framework.

Testing Boards and Assemblies

▼ To Test a CPU/Memory Board

Before you can test a CPU/Memory board, it must first be powered on and disconnected. If these conditions are not met, the board test fails.

You can use the Solaris `cfgadm` command to test CPU/memory boards. As superuser, type:

```
# cfgadm -t ap-id
```

To change the level of diagnostics that `cfgadm` runs, supply a diagnostic level for the `cfgadm` command as follows:

```
# cfgadm -o platform=diag=<level> -t ap-id
```

where *level* is a diagnostic level, and *ap-id* is one of the following: `N0.SB0`, `N0.SB2` or `N0.SB4`.

If you do not supply *level*, the default diagnostic level is set to the default. The diagnostic levels are:

TABLE 10-11 Diagnostic Levels

Diagnostic Level	Description
<code>init</code>	Only system board initialization code is run. No testing is done. This is a very fast pass through POST.
<code>quick</code>	All system board components are tested with few tests and test patterns.
<code>default</code>	All system board components are tested with all tests and test patterns, except for memory and Ecache modules. Note that <code>max</code> and <code>default</code> are the same definition.
<code>max</code>	All system board components are tested with all tests and test patterns, except for memory and Ecache modules. Note that <code>max</code> and <code>default</code> are the same definition.
<code>mem1</code>	Runs all tests at the <code>default</code> level, plus more exhaustive DRAM and SRAM test algorithms. For Memory and Ecache modules, all locations are tested with multiple patterns. More extensive, time-consuming algorithms are not run at this level.
<code>mem2</code>	The same as <code>mem1</code> , with the addition of a DRAM test that does explicit compare operations of the DRAM data.

Installing or Replacing CPU/Memory Boards



Caution – Physical board replacement should only be carried out by qualified service personnel.

▼ To Install a New Board



Caution – For complete information about physically removing and replacing CPU/Memory boards, refer to the *Sun Fire E2900 System Service Manual* or *Sun Fire V1280/Netra 1280 Service Manual*, as appropriate. Failure to follow the stated procedures can result in damage to system boards and other components.

Note – When replacing boards, you sometimes need filler panels.

If you are unfamiliar with how to insert a board into the system, read the *Sun Fire E2900 System Service Manual* or *Sun Fire V1280/Netra 1280 Service Manual*, as appropriate before you begin this procedure.

1. **Make sure you are properly grounded with a wrist strap.**
2. **After locating an empty slot, remove the system board filler panel from the slot.**
3. **Insert the board into the slot within one minute to prevent the system overheating.**

Refer to the *Sun Fire E2900 System Service Manual* or *Sun Fire V1280/Netra 1280 Service Manual*, as appropriate for complete step-by-step board insertion procedures.

4. **Power on, test, and configure the board using the `cfgadm -c configure` command:**

```
# cfgadm -c configure ap_id
```

where *ap_id* is one of the following: N0.SB0, N0.SB2 or N0.SB4.

▼ To Hot-Swap a CPU/Memory Board



Caution – For complete information about physically removing and replacing boards, refer to the *Sun Fire E2900 System Service Manual* or *Sun Fire V1280/Netra 1280 Service Manual*, as appropriate. Failure to follow the stated procedures can result in damage to system boards and other components.

1. **Make sure you are properly grounded using a wrist strap.**
2. **Power off the board with `cfgadm`.**

```
# cfgadm -c disconnect ap_id
```

where *ap_id* is one of the following: `N0.SB0`, `N0.SB2` or `N0.SB4`.

This command removes the resources from the Solaris operating environment and the OpenBoot PROM, and powers off the board.

3. **Verify the state of the Power and Hotplug OK LEDs.**

The green Power LED will flash briefly as the CPU/Memory board is cooling down. In order to safely remove the board from the systems the green Power LED must be off and the amber Hotplug OK LED must be on.

4. **Complete the hardware removal and installation of the board.**

For more information refer to the *Sun Fire E2900 System Service Manual* or *Sun Fire V1280/Netra 1280 Service Manual*, as appropriate.

5. **After removing and installing board, bring the board back to the Solaris operating environment with the Solaris dynamic reconfiguration `cfgadm` command.**

```
# cfgadm -c configure ap_id
```

where *ap_id* is one of the following: `N0.SB0`, `N0.SB2` or `N0.SB4`.

This command powers the board on, tests it, attaches the board, and brings all of its resources back to the Solaris operating environment.

6. **Verify that the green Power LED is lit.**

▼ To Remove a CPU/Memory Board From the System

Note – Before you begin this procedure, make sure you have ready a system board filler panel to replace the system board you are going to remove. A system board filler panel is a metal board with slots that allow cooling air to circulate.

1. **Detach and power off the board from the system by using the `cfgadm -c disconnect` command.**

```
# cfgadm -c disconnect ap_id
```

where *ap_id* is one of the following: N0.SB0, N0.SB2 or N0.SB4.



Caution – For complete information about physically removing and replacing boards, refer to the *Sun Fire E2900 System Service Manual* or *Sun Fire V1280/Netra 1280 Service Manual*, as appropriate. Failure to follow the stated procedures can result in damage to system boards and other components.

2. **Remove the board from the system.**

Refer to the *Sun Fire E2900 System Service Manual* or *Sun Fire V1280/Netra 1280 Service Manual*, as appropriate for complete step-by-step board removal procedures.

3. **Insert a system board filler panel into the slot within one minute of removing the board to prevent system overheating.**

▼ To Disconnect a CPU/Memory Board Temporarily

You can use DR to power down the board and leave it in place. For example, you might want to do this if the board fails and a replacement board or a system board filler panel is not available.

- **Detach and power off the board using the `cfgadm -c disconnect` command.**

```
# cfgadm -c disconnect ap_id
```

where *ap_id* is one of the following: N0.SB0, N0.SB2 or N0.SB4.

Troubleshooting

This section discusses common types of failure:

- Unconfigure Operation Failure
- Configure Operation Failure

The following are examples of `cfgadm` diagnostic messages. (Syntax error messages are not included here.)

```
cfgadm: hardware component is busy, try again
cfgadm: operation: Data error: error_text
cfgadm: operation: Hardware specific failure: error_text
cfgadm: operation: Insufficient privileges
cfgadm: operation: Operation requires a service interruption
cfgadm: System is busy, try again
WARNING: Processor number number failed to offline.
```

See the following man pages for additional error message detail: `cfgadm(1M)`, `cfgadm_sbd(1M)`, and `config_admin(3X)`.

Unconfigure Operation Failure

An unconfigure operation for a CPU/Memory board can fail if the system is not in a correct state before you begin the operation.

CPU/Memory Board Unconfiguration Failures

- Memory on a board is interleaved across boards before an attempt to unconfigure the board.
- A process is bound to a CPU before an attempt to unconfigure the CPU.
- Memory remains configured on a system board before you attempt a CPU unconfigure operation on that board.
- The memory on the board is configured (in use). See “Unable to Unconfigure Memory on a Board With Permanent Memory” on page 120.
- CPUs on the board cannot be taken off line. See “Unable to Unconfigure a CPU” on page 122.

Cannot Unconfigure a Board Whose Memory Is Interleaved Across Boards

If you try to unconfigure a system board whose memory is interleaved across system boards, the system displays an error message such as:

```
cfgadm: Hardware specific failure: unconfigure N0.SB2::memory: Memory is interleaved across boards: /ssm@0,0/memory-controller@b,400000
```

Cannot Unconfigure a CPU to Which a Process is Bound

If you try to unconfigure a CPU to which a process is bound, the system displays an error message such as the following:

```
cfgadm: Hardware specific failure: unconfigure N0.SB2::cpu3: Failed to off-line: /ssm@0,0/SUNW,UltraSPARC-III
```

- **Unbind the process from the CPU and retry the unconfigure operation.**

Cannot Unconfigure a CPU Before All Memory is Unconfigured

All memory on a system board must be unconfigured before you try to unconfigure a CPU. If you try to unconfigure a CPU before all memory on the board is unconfigured, the system displays an error message such as:

```
cfgadm: Hardware specific failure: unconfigure N0.SB2::cpu0: Can't unconfig cpu if mem online: /ssm@0,0/memory-controller
```

- **Unconfigure all memory on the board and then unconfigure the CPU.**

Unable to Unconfigure Memory on a Board With Permanent Memory

To unconfigure the memory on a board that has permanent memory, move the permanent memory pages to another board that has enough available memory to hold them. Such an additional board must be available before the unconfigure operation begins.

Memory Cannot Be Reconfigured

If the unconfigure operation fails with a message such as the following, the memory on the board could not be unconfigured:

```
cfgadm: Hardware specific failure: unconfigure N0.SB0: No available memory
target: /ssm@0,0/memory-controller@3,400000
```

Add to another board enough memory to hold the permanent memory pages, and then retry the unconfigure operation.

To confirm that a memory page cannot be moved, use the verbose option with the `cfgadm` command and look for the word `permanent` in the listing:

```
# cfgadm -av -s "select=type(memory)"
```

Not Enough Available Memory

If the unconfigure fails with one of the messages below, there will not be enough available memory in the system if the board is removed:

```
cfgadm: Hardware specific failure: unconfigure N0.SB0: Insufficient memory
```

- **Reduce the memory load on the system and try again. If practical, install more memory in another board slot.**

Memory Demand Increased

If the unconfigure fails with the following message, the memory demand has increased while the unconfigure operation was proceeding:

```
cfgadm: Hardware specific failure: unconfigure N0.SB0: Memory operation failed
```

```
cfgadm: Hardware specific failure: unconfigure N0.SB0: Memory operation refused
```

- **Reduce the memory load on the system and try again.**

Unable to Unconfigure a CPU

CPU unconfiguration is part of the unconfiguration operation for a CPU/Memory board. If the operation fails to take the CPU offline, the following message is logged to the console:

```
WARNING: Processor number failed to offline.
```

This failure occurs if:

- The CPU has processes bound to it.
- The CPU is the last one in a CPU set.
- The CPU is the last online CPU in the system.

Unable to Disconnect a Board

It is possible to unconfigure a board and then discover that it cannot be disconnected. The `cfgadm` status display lists the board as not detachable. This problem occurs when the board is supplying an essential hardware service that cannot be relocated to an alternate board.

Configure Operation Failure

CPU/Memory Board Configuration Failure

Cannot Configure Either CPU0 or CPU1 While the Other Is Configured

Before you try to configure either CPU0 or CPU1, make sure that the other CPU is unconfigured. Once both CPU0 and CPU1 are unconfigured, it is then possible to configure both of them.

CPUs on a Board Must Be Configured Before Memory

Before configuring memory, all CPUs on the system board must be configured. If you try to configure memory while one or more CPUs are unconfigured, the system displays an error message such as:

```
cfgadm: Hardware specific failure: configure N0.SB2::memory: Can't  
config memory if not all cpus are online: /ssm@0,0/memorycontroller
```

Glossary

ap_id	Attachment point identifier; an <code>ap_id</code> specifies the type and location of the attachment point in the system and is unambiguous. There are two types of identifier: physical and logical. A physical identifier contains a fully specified pathname, while a logical identifier contains a shorthand notation.
Attachment point	A collective term for a board and its card cage slot. A <i>physical</i> attachment point describes the software driver and location of the card cage slot. A <i>logical</i> attachment point is an abbreviated name created by the system to refer to the physical attachment point.
cfgadm command	<code>cfgadm</code> is the primary command for dynamic reconfiguration on the Sun Fire Entry-Level Midrange Systems system. For information about the command and its options, refer to the <code>cfgadm(1M)</code> , <code>cfgadm_sbd(1M)</code> , and <code>cfgadm_pci(1M)</code> man pages. For any late-breaking news about this and related commands, refer to the Solaris 8 section at the DR web site. See Chapter 10.
Condition	The operational status of an attachment point.
Configuration (system)	The collection of attached devices known to the system. The system cannot use a physical device until the configuration is updated. The operating system assigns functional roles to a board and loads device drivers for the board and for devices attached to the board.
Configuration (board)	The operating system assigns functional roles to a board and loads device drivers for the board and for devices attached to the board.
Connection	A board is present in a slot and is electrically connected. The temperature of the slot is monitored by the system.
Detachability	The device driver supports <code>DDI_DETACH</code> and the device (such as an I/O board or a SCSI chain) is physically arranged so that it can be detached.
Disconnection	The system stops monitoring the board and power to the slot is turned off. A board in this state can be unplugged.

DR See Dynamic Reconfiguration

Dynamic Reconfiguration

Dynamic Reconfiguration (DR) is software that allows the administrator to (1) view a system configuration; (2) suspend or restart operations involving a port, storage device, or board; and (3) reconfigure the system (detach or attach hotswappable devices such as disk drives or interface boards) without the need to power down the system. When DR is used with IPMP or Solstice DiskSuite software (and redundant hardware), the server can continue to communicate with disk drives and networks without interruption while a service provider replaces an existing device or installs a new device. DR supports replacement of a CPU/Memory, provided the memory on the board is not interleaved with memory on other boards in the system.

Hot-plug Hot-plug boards and modules have special connectors that supply electrical power to the board or module before the data pins make contact. Boards and devices that do not have hot-plug connectors cannot be inserted or removed while the system is running.

Hot swap A hot swap device has special DC power connectors and logic circuitry that allow the device to be inserted without the necessity of turning off the system.

IP Multipathing (IPMP)

Internet Protocol multipathing. Enables continuous application availability by load balancing failures when multiple network interface cards are attached to a system. If a failure occurs in a network adapter, and if an alternate adapter is connected to the same IP link, the system switches all the network accesses from the failed adapter to the alternate adapter. When multiple network adapters are connected to the same IP link, any increases in network traffic are spread across multiple network adapters, which improves network throughput.

Logical DR A DR operation in which hardware is not physically added or removed. An example is the deactivation of a failed board that is then left in the slot (to avoid changing the flow of cooling air) until a replacement is available.

Occupant Hardware resource such as a system board or a disk drive that occupies a DR receptacle or slot.

Platform A specific Sun Fire system model, such as the Sun Fire Entry-Level Midrange Systems system.

Physical DR A DR operation that involves the physical addition or removal of a board. See also "Logical DR."

Quiescence A brief pause in the operating environment to allow an unconfigure and disconnect operation on a system board with non-pageable OpenBoot PROM (OBP) or kernel memory. All operating environment and device activity on the backplane must cease for a few seconds during a critical phase of the operation.

Receptacle A receiver such as a board slot or SCSI chain.

Port	A board connector.
SNMP	Simple Network Management Protocol. SNMP is any system listening to SNMP events.
State	The operational status of either a receptacle (slot) or an occupant (board).
Suspendability	To be suitable for DR, a device driver must have the ability to stop user threads, execute the <code>DDI_SUSPEND</code> call, stop the clock, and stop the CPUs.
Suspend-safe	A suspend-safe device is one that does not access memory or interrupt the system while the operating system is in quiescence. A driver is considered suspend-safe if it supports operating system quiescence (suspend/resume). It also guarantees that when a suspend request is successfully completed, the device that the driver manages will not attempt to access memory, even if the device is open when the suspend request is made.
Suspend-unsafe	A suspend-unsafe device is one that allows a memory access or a system interruption while the operating system is in quiescence.
System Controller software	The main application that performs all of the System Controller hardware management functions.
Unconfiguration	The system detaches a board logically from the operating system and takes the associated device drivers off-line. Environmental monitoring continues, but any devices on the board are not available for system use.

Index

A

- alarms, checking status, 47
- alarms, setting, 54
- attachment points, 105
- auto-boot? OpenBoot variable, 59
- auto-diagnosis (AD) engine, 65
- auto-restoration, 67
- availability, 7

B

- blacklisting
 - components, 82
 - manual, 82
- board
 - condition, 108
 - displaying status, 111
 - occupant state, 107
 - receptacle state, 107
- board status, detailed, 112
- bootmode command, 58, 61

C

- cfgadm command, 103, 111
- componens
 - blacklisting, 82
 - disabling, 82
- component
 - condition, 109

- occupant state, 108
- receptacle state, 108
- state, 108
- type, 109

- component health status (CHS), 67
- condition, component, 107
- CPU/Memory board, replacement, 103
- CPU/Memory mapping, 75

D

- date and time, setting, 19
- device name mapping, 75
- device path names to physical system devices, 75
- diag-level OpenBoot variable, 58
- diagnostic information
 - auto-diagnosis, 66
- diagnostic information, displaying, 90
- disablecomponent command, 83
- disabling a component, 82
- domain
 - auto-restoration, 67
 - console, 4
 - hang recovery, 67
- Dynamic Reconfiguration, 103

E

- enablecomponent command, 83
- environmental monitoring, 4

error-level OpenBoot variable, 58
error-reset-recovery OpenBoot variable, 59
event reporting, 55

F

failures, determining causes, 91
fans, checking status, 49
fault LED, checking status remotely, 47
fault, system, 80
firmware, upgrading, 93
flashupdate command, 93

H

hangs, determining causes, 91
hard hung system, recovering from, 86
hardware, powering on, 18
hot-plug devices, 106
hung system, recovering, 85
hung system, recovering from, 86

I

I/O assemblies
 mapping, 76
initial power-on, 14
interleave-mode OpenBoot variable, 59
interleave-scope OpenBoot variable, 59
internal temperature, checking, 52
internal voltage sensors, 49

L

logical attachment point, 105
LOM

 escape sequence, changing, 55
 monitoring the system, 46 to 53
 online documentation, 46
 sample Event Log, 48
 setting the alarms, 54
lom -A command, 54

lom -E command, 55
lom -f command, 49
lom -G command, 97
lom -l command, 47

LOM prompt

 accessing, 39

LOM serial port, 55
 stopping event reporting, 55

lom -t command, 52
lom -v command, 49
lom -X command, 55

M

maintenance, 93
manual blacklisting, 82
mapping, 75
 CPU/Memory, 75
 I/O assembly, 76
 node, 75
memory
 interleaved, 110
 nonpermanent, 109
 permanent, 109
 reconfiguring, 110
messages
 event, 70
monitoring
 hung domains, 67
monitoring, environmental conditions, 4

N

navigation procedures, 29
network parameters, setting, 20
node mapping, 75
nonpermanent memory, 109

O

On/Standby switch, 13
OpenBoot PROM variables, 57
OpenBoot prompt, accessing, 41

overtemperature, 87

P

password command, 20
password, setting, 20
permanent memory, 109
physical attachment point, 105
POST, 57
 controlling, 57, 61
 OpenBoot PROM variables, 57
power supply, 90
powering on hardware, 18
power-off, 15
 to standby, 15
poweroff command, 17
power-on, 14
 from standby, 14
 initial, 14
poweron command, 15
power-on self test, *See* POST
printenv command, 58

Q

quiescence, 104

R

RAS, 6
reboot-on-error OpenBoot variable, 59
recovering from a hard hung system, 86
reliability, 6
restoration controls, 69

S

SCPOST, controlling, 62
serviceability, 8
setdate command, 19
setenv command, 58
setupnetwork command, 20

setupsc command, 62
showcomponent command, 73, 83
showenvironment command, 87
showlogs command, 70
shutdown command, 16
Solaris console
 accessing, 39
Solaris, installing and booting, 22
standby
 power off to, 15
 power on from, 14
state, component, 107
suspend-safe devices, 104
suspend-unsafe devices, 104
system
 hard hung, recovering from, 86
System Controller POST, *See* SCPOST
system faults, 80
system identity, moving, 87
system, hung, recovering, 85

T

temperature, 87
terminal, connecting, 30
troubleshooting, 75

U

use-nvramrc? OpenBoot variable, 59

V

verbosity-level OpenBoot variable, 58
voltage sensors, 49

