



Sun Enterprise™ 10000 Dynamic Reconfiguration User Guide

Sun Microsystems, Inc.
901 San Antonio Road
Palo Alto, CA 94303-4900
U.S.A. 650-960-1300

Part No. 806-2249-10
February 2000, Revision 01

Send comments about this document to: docfeedback@sun.com

Copyright 2000 Sun Microsystems, Inc., 901 San Antonio Road, Palo Alto, California 94303-4900 U.S.A. All rights reserved.

This product or document is protected by copyright and distributed under licenses restricting its use, copying, distribution, and decompilation. No part of this product or document may be reproduced in any form by any means without prior written authorization of Sun and its licensors, if any. Third-party software, including font technology, is copyrighted and licensed from Sun suppliers.

Parts of the product may be derived from Berkeley BSD systems, licensed from the University of California. UNIX is a registered trademark in the U.S. and other countries, exclusively licensed through X/Open Company, Ltd. For Netscape Communicator™, the following notice applies: (c) Copyright 1995 Netscape Communications Corporation. All rights reserved.

Sun, Sun Microsystems, the Sun logo, AnswerBook2, docs.sun.com, Solstice, DiskSuite, SunFastEthernet, Ultra Enterprise, Sun Enterprise, OpenBoot, and Solaris are trademarks, registered trademarks, or service marks of Sun Microsystems, Inc. in the U.S. and other countries. All SPARC trademarks are used under license and are trademarks or registered trademarks of SPARC International, Inc. in the U.S. and other countries. Products bearing SPARC trademarks are based upon an architecture developed by Sun Microsystems, Inc.

The OPEN LOOK and Sun™ Graphical User Interface was developed by Sun Microsystems, Inc. for its users and licensees. Sun acknowledges the pioneering efforts of Xerox in researching and developing the concept of visual or graphical user interfaces for the computer industry. Sun holds a non-exclusive license from Xerox to the Xerox Graphical User Interface, which license also covers Sun's licensees who implement OPEN LOOK GUIs and otherwise comply with Sun's written license agreements.

RESTRICTED RIGHTS: Use, duplication, or disclosure by the U.S. Government is subject to restrictions of FAR 52.227-14(g)(2)(6/87) and FAR 52.227-19(6/87), or DFAR 252.227-7015(b)(6/95) and DFAR 227.7202-3(a).

DOCUMENTATION IS PROVIDED "AS IS" AND ALL EXPRESS OR IMPLIED CONDITIONS, REPRESENTATIONS AND WARRANTIES, INCLUDING ANY IMPLIED WARRANTY OF MERCHANTABILITY, FITNESS FOR A PARTICULAR PURPOSE OR NON-INFRINGEMENT, ARE DISCLAIMED, EXCEPT TO THE EXTENT THAT SUCH DISCLAIMERS ARE HELD TO BE LEGALLY INVALID.

Copyright 2000 Sun Microsystems, Inc., 901 San Antonio Road, Palo Alto, Californie 94303 Etats-Unis. Tous droits réservés.

Ce produit ou document est protégé par un copyright et distribué avec des licences qui en restreignent l'utilisation, la copie, la distribution, et la décompilation. Aucune partie de ce produit ou document ne peut être reproduite sous aucune forme, par quelque moyen que ce soit, sans l'autorisation préalable et écrite de Sun et de ses bailleurs de licence, s'il y en a. Le logiciel détenu par des tiers, et qui comprend la technologie relative aux polices de caractères, est protégé par un copyright et licencié par des fournisseurs de Sun.

Des parties de ce produit pourront être dérivées des systèmes Berkeley BSD licenciés par l'Université de Californie. UNIX est une marque déposée aux Etats-Unis et dans d'autres pays et licenciée exclusivement par X/Open Company, Ltd. La notice suivante est applicable à Netscape Communicator™: (c) Copyright 1995 Netscape Communications Corporation. Tous droits réservés.

Sun, Sun Microsystems, le logo Sun, AnswerBook2, docs.sun.com, Solstice, DiskSuite, SunFastEthernet, Ultra Enterprise, Sun Enterprise, OpenBoot, et Solaris sont des marques de fabrique ou des marques déposées, ou marques de service, de Sun Microsystems, Inc. aux Etats-Unis et dans d'autres pays. Toutes les marques SPARC sont utilisées sous licence et sont des marques de fabrique ou des marques déposées de SPARC International, Inc. aux Etats-Unis et dans d'autres pays. Les produits portant les marques SPARC sont basés sur une architecture développée par Sun Microsystems, Inc.

L'interface d'utilisation graphique OPEN LOOK et Sun™ a été développée par Sun Microsystems, Inc. pour ses utilisateurs et licenciés. Sun reconnaît les efforts de pionniers de Xerox pour la recherche et le développement du concept des interfaces d'utilisation visuelle ou graphique pour l'industrie de l'informatique. Sun détient une licence non exclusive de Xerox sur l'interface d'utilisation graphique Xerox, cette licence couvrant également les licenciés de Sun qui mettent en place l'interface d'utilisation graphique OPEN LOOK et qui en outre se conforment aux licences écrites de Sun.

CETTE PUBLICATION EST FOURNIE "EN L'ETAT" ET AUCUNE GARANTIE, EXPRESSE OU IMPLICITE, N'EST ACCORDEE, Y COMPRIS DES GARANTIES CONCERNANT LA VALEUR MARCHANDE, L'APTITUDE DE LA PUBLICATION A REPENDRE A UNE UTILISATION PARTICULIERE, OU LE FAIT QU'ELLE NE SOIT PAS CONTREFAISANTE DE PRODUIT DE TIERS. CE DENI DE GARANTIE NE S'APPLIQUERAIT PAS, DANS LA MESURE OU IL SERAIT TENU JURIDIQUEMENT NUL ET NON AVENU.



Sun Enterprise 10000 SSP Attributions:

This software is copyrighted by the Regents of the University of California, Sun Microsystems, Inc., and other parties. The following terms apply to all files associated with the software unless explicitly disclaimed in individual files.

The authors hereby grant permission to use, copy, modify, distribute, and license this software and its documentation for any purpose, provided that existing copyright notices are retained in all copies and that this notice is included verbatim in any distributions. No written agreement, license, or royalty fee is required for any of the authorized uses. Modifications to this software may be copyrighted by their authors and need not follow the licensing terms described here, provided that the new terms are clearly indicated on the first page of each file where they apply.

IN NO EVENT SHALL THE AUTHORS OR DISTRIBUTORS BE LIABLE TO ANY PARTY FOR DIRECT, INDIRECT, SPECIAL, INCIDENTAL, OR CONSEQUENTIAL DAMAGES ARISING OUT OF THE USE OF THIS SOFTWARE, ITS DOCUMENTATION, OR ANY DERIVATIVES THEREOF, EVEN IF THE AUTHORS HAVE BEEN ADVISED OF THE POSSIBILITY OF SUCH DAMAGE.

THE AUTHORS AND DISTRIBUTORS SPECIFICALLY DISCLAIM ANY WARRANTIES, INCLUDING, BUT NOT LIMITED TO, THE IMPLIED WARRANTIES OF MERCHANTABILITY, FITNESS FOR A PARTICULAR PURPOSE, AND NON-INFRINGEMENT. THIS SOFTWARE IS PROVIDED ON AN "AS IS" BASIS, AND THE AUTHORS AND DISTRIBUTORS HAVE NO OBLIGATION TO PROVIDE MAINTENANCE, SUPPORT, UPDATES, ENHANCEMENTS, OR MODIFICATIONS.

RESTRICTED RIGHTS: Use, duplication or disclosure by the government is subject to the restrictions as set forth in subparagraph (c) (1) (ii) of the Rights in Technical Data and Computer Software Clause as DFARS 252.227-7013 and FAR 52.227-19.

This is scotty, a simple tcl interpreter with some special commands to get information about TCP/IP networks. Copyright (c) 1993, 1994, 1995, J. Schoenwaelder, TU Braunschweig, Germany, Institute for Operating Systems and Computer Networks. Permission to use, copy, modify, and distribute this software and its documentation for any purpose and without fee is hereby granted, provided that this copyright notice appears in all copies. The University of Braunschweig makes no representations about the suitability of this software for any purpose. It is provided "as is" without express or implied warranty.

Contents

1. Introduction to DR	1
2. DR Configuration Issues	3
dr-max-mem Variable	3
▼ To Enable the Kernel Cage	3
Configuration for DR Detach	4
I/O Devices	4
Memory	5
Pageable and Nonpageable Memory	5
Target Memory Constraints	6
Correctable Memory Errors	6
▼ To Re-Enable Dump Detection	7
Swap Space	7
Reconfiguration After a DR Operation	7
When to Reconfigure	8
Disk Devices	8
DR and AP Interaction	9
DR and IDNs	9
RPC Time-Out or Loss of Connection	10
System Quiescence Operation	11

Suspend-Safe/Suspend-Unsafe Devices	12
Special Handling for Tape Devices	13
Special Handling of Sun StorEdge A3000	14
DR and DDI	14
DR and DDI_DETACH	14
DR and DDI_SUSPEND/DDI_RESUME	15

3. Using Dynamic Reconfiguration 17

Attaching a System Board	17
Init Attach	17
Complete Attach	18
Attach Buttons	19
▼ To Attach a Board With Hostview	19
▼ To Attach a Board By Using <code>dr(1M)</code>	23
Detaching a System Board	26
Drain	26
Complete Detach	27
Network Devices	27
Non-Network Devices	28
Processes	29
Processors	30
Finishing the Complete Detach Operation	30
Hostview Detach Buttons	31
▼ To Detach a Board With Hostview	32
▼ To Detach a Board By Using <code>dr(1M)</code>	34
Viewing Domain Information	37
▼ To View Domain Information with Hostview	38
▼ To Specify How Windows Are Updated	38

- ▼ To View DR CPU Configuration Information 39
- ▼ To View DR Memory Configuration Information 41
- ▼ To View DR Device Configuration Information 43
- ▼ To View DR Device Detailed Information 44
- ▼ To View DR OBP Configuration Information 45
- ▼ To View the DR-Unsafe Devices 46

Figures

- FIGURE 3-1 Attach Board and Domain Selection Window 20
- FIGURE 3-2 Dynamic Reconfiguration Window With `init attach` Button 21
- FIGURE 3-3 Dynamic Reconfiguration Window With the `complete` Button 22
- FIGURE 3-4 Detach—Board and Domain Selection Window 32
- FIGURE 3-5 Dynamic Reconfiguration Window With the `drain` Button 33
- FIGURE 3-6 System Information Buttons 38
- FIGURE 3-7 DR Properties Window 39
- FIGURE 3-8 DR CPU Configuration Window 40
- FIGURE 3-9 DR Memory Configuration Window 41
- FIGURE 3-10 DR Device Configuration Window 43
- FIGURE 3-11 DR Detail Device Window 44
- FIGURE 3-12 DR OBP Configuration Window 46
- FIGURE 3-13 DR Unsafe Devices Window 47

Preface

This book describes the Dynamic Reconfiguration (DR) feature, which enables you to logically attach and detach system boards from the Sun Enterprise™ 10000 server while other domains continue running.

Before You Read This Book

This book is intended for the Sun Enterprise 10000 server system administrator who has a working knowledge of UNIX® systems, particularly those based on the Solaris™ operating environment. If you do not have such knowledge, first read the *Solaris User and System Administrator* in AnswerBook2™ format provided with this system and consider UNIX system administration training.

How This Book Is Organized

This document contains the following chapters:

Chapter 1 introduces basic concepts related to the Dynamic Reconfiguration feature.

Chapter 2 describes how to configure the Dynamic Reconfiguration system before you begin using it.

Chapter 3 describes how to use DR to attach and detach system boards.

Appendix A contains DR error messages.

Using UNIX Commands

This document does not contain information on basic UNIX commands and procedures such as shutting down the system, booting the system, and configuring devices.

See one or more of the following sources for this information:

- AnswerBook2 online documentation for the Solaris operating environment, particularly those dealing with Solaris system administration
- Other software documentation that you received with your system

Typographic Conventions

Typeface or Symbol	Meaning	Examples
AaBbCc123	The names of commands, files, and directories; on-screen computer output	Edit your <code>.login</code> file. Use <code>ls -a</code> to list all files. % You have mail.
AaBbCc123	What you type, when contrasted with on-screen computer output	% su Password:
<i>AaBbCc123</i>	Book titles, new words or terms, words to be emphasized	Read Chapter 6 in the <i>User's Guide</i> . These are called <i>class</i> options. You <i>must</i> be superuser to do this.
	Command-line variable; replace with a real name or value	To delete a file, type <code>rm filename</code> .

Shell Prompts

Shell	Prompt
C shell	<i>machine_name%</i>
C shell superuser	<i>machine_name#</i>
Bourne shell and Korn shell	\$
Bourne shell and Korn shell superuser	#

Related Documentation

TABLE P-1 Related Documentation

Application	Title	Part Number
User	<i>Sun Enterprise 10000 SSP User Guide</i>	805-2955
Reference	<i>Sun Enterprise 10000 SSP Reference Manual</i>	805-3362
	<i>Sun Enterprise 10000 Dynamic Reconfiguration Reference Manual</i>	806-2250
Release Notes	<i>Release Notes Supplement Solaris 8</i>	Printed in Media Kit.

Ordering Sun Documentation

Fatbrain.com, an Internet professional bookstore, stocks select product documentation from Sun Microsystems, Inc.

For a list of documents and how to order them, visit the Sun Documentation Center on Fatbrain.com at:

<http://www1.fatbrain.com/documentation/sun>

Accessing Sun Documentation Online

The `docs.sun.com`SM web site enables you to access Sun technical documentation on the Web. You can browse the `docs.sun.com` archive or search for a specific book title or subject at:

<http://docs.sun.com>

Sun Welcomes Your Comments

We are interested in improving our documentation and welcome your comments and suggestions. You can email your comments to us at:

`docfeedback@sun.com`

Please include the part number (806-2249-10) of your document in the subject line of your email.

Introduction to DR

Dynamic Reconfiguration (DR) enables you to logically attach and detach system boards to and from the operating system without causing machine downtime. DR is used in conjunction with hot swap, which is the process of physically removing or inserting a system board. You can use DR to add a new system board, reinstall a repaired system board, or modify the domain configuration on the Sun Enterprise 10000 system.

If a system board is being used by a domain, you must detach it before you can power it off and remove it. After a new or upgraded system board is inserted and powered on, you may attach it to the domain.

You can execute DR operations from the SSP through the Hostview GUI (see `hostview(1M)`) or through the `dr(1M)` shell application. DR supports the following operations:

- **DR Attach** – Logically attaches a system board to the operating system running in a domain. A system board is logically attached when its resources—processors, memory, and I/O adapters—are configured into a domain and are available to the Solaris operating environment. The system board must already be present in the system, powered on, and not be a member of a domain. Normally, you attach a system board after it is inserted and powered on by your service provider or after it is detached from another domain.
- **DR Detach** – Logically detaches a system board from a domain. A system board is logically detached when its resources—processors, memory, and I/O adapters—are removed from the domain configuration and are no longer available to the domain. Normally, you detach a system board to either move it to another domain or prepare it for removal.

While DR operations are being performed within a domain, the `dr_daemon(1M)` (see the *Sun Enterprise 10000 Dynamic Reconfiguration Reference Manual*) and the operating environment write messages regarding the status or exceptions of DR requests to the domain syslog message buffer (`/var/adm/messages`) and the SSP message files (`$$SSPOPT/adm/host/messages` and `$$SSPOPT/adm/messages`). In

addition to the status and exception information displayed by Hostview and the `dr(1M)` shell application, the `dr_daemon(1M)` and operating environment messages are useful for determining the status of DR requests.

Note – Only one DR operation per platform can be active at any time. A DR operation that is partially completed and then dismissed within one domain does not prevent a subsequent DR operation from being started in a different domain. A partially completed DR operation must be finished before a subsequent DR operation is permitted in the same domain.

DR Configuration Issues

This chapter describes how to configure a domain for all DR operations and capabilities.



Caution – Be careful when choosing the slot into which a board is inserted to prevent disk controller renumbering. For more information, see “Reconfiguration After a DR Operation” on page 7.

dr-max-mem Variable

With the Solaris 7 and Solaris 8 operating environments, `dr-max-mem` is no longer used. Instead, the DR feature, specifically DR Detach, must be enabled by using the `system(4)` variable `kernel_cage_enable`. A caged kernel confines the nonpageable memory to a minimal (most often one) number of systems boards. By default, the kernel cage is disabled, preventing DR Detach operations.

Note – DR Attach is enabled regardless of the setting of `kernel_cage_enable`.

▼ To Enable the Kernel Cage

1. Edit the `/etc/system` file so that `kernel_cage_enable` equals 1.

```
set kernel_cage_enable=1
```

2. Reboot the domain.

After the reboot completes successfully, you can verify that the kernel cage is enabled by reviewing the `/var/adm/messages` file for the following message.

```
NOTICE: DR Kernel Cage is ENABLED
```

Configuration for DR Detach

This section describes how to configure DR before you perform a detach operation.

I/O Devices

The DR Detach feature works with Alternate Pathing (AP) or Solstice™ DiskSuite™ mirroring when you detach a board that hosts I/O controllers that are attached to vital system resources. If, for example, the root (`/`) or `/usr` partition is on a disk attached to a controller on the board, the board cannot be detached unless there is a hardware alternate path to the disk, and AP has been configured to take advantage of it, or the disk is mirrored. The alternate path or the mirrors must be hosted by other boards in the domain. The same applies to network controllers. The board that hosts the Ethernet controller that connects the SSP to the Sun Enterprise 10000 platform cannot be detached unless an alternate path exists to an Ethernet controller on another board for this network connection.

To enable device suspension for the `soc` and `pln` drivers, you must edit the `/etc/system` file so that the `pln_enable_detach_suspend` and `soc_enable_detach_suspend` variables are set to 1, as in the following example:

```
set pln:pln_enable_detach_suspend=1
set soc:soc_enable_detach_suspend=1
```

The domain swap space should be configured as multiple partitions on disks attached to controllers hosted by different boards. With this kind of configuration, a particular swap partition is not a vital resource because swap partitions can be added and deleted dynamically (see `swap(1M)` for more information).

Note – When memory (`swapfs`) or swap space on a disk is detached, there must be enough memory or swap space remaining in the domain to accommodate currently running programs.

A board that hosts non-vital system resources can be detached whether or not there are alternate paths to the resources. All of the devices on the board must be closed before the board can be detached; all of its file systems must be unmounted; and, its swap partitions must be deleted. You may have to kill processes that have open files or devices, or place a hard lock on the file systems (using `lockfs(1M)`) before you unmount the boards.

All I/O device drivers involved with I/O devices on the board(s) must support the `DDI_DETACH` option in the detach entry-point of the driver. This option releases all system resources associated with that device or adapter.

Memory

If you use memory interleaving between system boards, those system boards cannot be detached because DR does not yet support interboard interleaving. By default, `hpost(1M)` does not set up boards with interleaved memory. Look for the following line in the `hpost(1M)` file `.postrc` (see `postrc(4)`):

```
mem_board_interleave_ok
```

If `mem_board_interleave_ok` is present, you may not be able to detach a board that uses memory interleaving.

Note – If you use the `ndd(1m)` command to set the configuration parameters for network drivers, the parameters may not persist after a DR Detach or DR Attach operation. Use the `/etc/system` file or the `driver.conf` file for a specific driver to set the parameters permanently.

Pageable and Nonpageable Memory

Before you can detach a board, the operating system must vacate the memory on that board. Vacating a board means flushing its pageable memory to swap space and copying its nonpageable (that is, kernel and OBP memory) to another memory board. To relocate nonpageable memory, the operating environment on a domain must be temporarily suspended, or quiesced. The length of the suspension depends on the domain I/O configuration and the running workloads. Detaching a board with nonpageable memory is the only time when the operating environment is suspended; therefore, you should know where nonpageable memory resides, so you can avoid significantly impacting the operation of the domain. When permanent memory is on the board, the operating environment must find other memory to receive the copy.

You can use the `dr(1M)` command `drshow(1M)` to determine if the memory on a board is pageable or nonpageable:

```
% dr
dr> drshow board_number mem
```

Similarly, you can determine if the memory on a board is pageable by looking at the DR Memory Configuration window, which is available when you perform a detach operation within Hostview. The DR Memory Configuration window is described in “Viewing Domain Information” on page 37.

Target Memory Constraints

When permanent memory is detached, DR chooses a target memory area to receive a copy of the memory. The DR software automatically checks for total adherence. It does not allow the DR memory operation to continue if it cannot verify total adherence. A DR memory operation might be disallowed because of the following reasons:

- The domain is not large enough to hold a copy of the nonpageable memory.
- The domain is interleaved with memory on other boards.

In the Solaris 7 5/99 version, if no target board is found, the detach operation is refused, and DR displays the following warning message on the system console:

```
WARNING: sfdr: sfdr_pre_release_mem: no available target for mem-
unit (board.0)
```

Correctable Memory Errors

Correctable memory errors indicate that the memory on a system board (that is, one or more of its Dual Inline Memory Modules (DIMMs), or portions of the hardware interconnect) may be faulty and need replacement. When the SSP detects correctable memory errors, it initiates a record-stop dump to save the diagnostic data, which can interfere with a DR detach operation. Therefore, Sun Microsystems suggests that when a record-stop occurs from a correctable memory error, you allow the record-stop dump to complete its process before you initiate a DR Detach operation.

If the faulty component causes repeated reporting of correctable memory errors, the SSP performs multiple record-stop dumps. If this happens, you should temporarily disable the dump-detection mechanism on the SSP, allow the current dump to finish, then initiate the DR Detach operation. After the detach operation finishes, you should re-enable the dump detection.

▼ To Re-Enable Dump Detection

1. **Log in to the SSP as the user ssp.**
2. **Disable record-stop dump detection:**

```
SSP% edd_cmd -x stop
```

This command suspends all event detection on all of the domains.

3. **Monitor the in-progress record-stop dump:**

```
SSP% ps -ef | grep hpost
```

In the `grep(1)` output, the `-D` option of `hpost` indicates that a record-stop dump is in progress.

4. **Perform the DR Detach operation.**
5. **Enable event detection:**

```
SSP% edd_cmd -x start
```

Swap Space

The domain swap configuration consists of the swap devices and `swapfs` (memory). The domain must contain enough swap space so that it can flush pageable memory. For example, if you want to remove 1 Gbyte of memory from a 2-Gbyte domain, you will need 1 Gbyte of swap space, depending on the load. Insufficient swap space prevents DR from completing the detach of a board that contains memory. If this happens, the memory drain phase does not complete, so you must abort the detach operation.

Reconfiguration After a DR Operation

This section describes how to reconfigure your domain after you have attached or detached a system board.

The DR user interface enables you reconfigure the domain after a DR Attach or DR Detach operation. The reconfiguration sequence is the same as the reconfiguration boot sequence (`boot -r`):

```
drvconfig; devlinks; disks; ports; tapes;
```

When you execute the reconfiguration sequence after you attach a board, device path names not previously seen by the domain are written to the `/etc/path_to_inst` file. The same path names are also added to the `/devices` hierarchy, and links to them are created in the `/dev` directory.

When to Reconfigure

You should reconfigure the domain if any of the following conditions occur:

- **Board Addition** – When you add a board to a domain, you must execute the reconfiguration sequence to configure the I/O devices that are associated with the board.
- **Board Deletion** – If you remove a board that is not to be replaced, you may, but do not have to, execute the reconfiguration sequence to clean up the `/dev` links.
- **Board Replacement** – If you remove a board then reinsert it in a different slot or if you replace a board with another board that has different I/O devices, you must execute the reconfiguration sequence to configure the I/O devices that are associated with the board. However, if you replace a board with another board that hosts the *same* set of I/O devices, inserting the replacement into the *same* slot, you do not need to execute the reconfiguration sequence. But, be sure to insert a replacement board into the same slot that was vacated to retain the original mapping of `/dev` links to physical names.

Disk Devices

Disk controllers are numbered consecutively as the `disks(1M)` program encounters them. All disk partitions are assigned `/dev` names according to the disk controller number that `disks(1M)` assigns. For example, all disk partitions that are accessible using disk controller 1 are named `/dev/dsk/cXtYdZsW`

where:

`x` is the disk controller number,

`Y`, in most cases, corresponds to the disk target number,

`Z` corresponds to the logical unit number, and

W corresponds to the partition number.

When the reconfiguration sequence is executed after a board is detached, the `/dev` links for all of the disk partitions on that board are deleted. The remaining boards retain their current numbering. Disk controllers on a newly inserted board are assigned the next available lowest number by `disks(1M)`.

Note – The disk controller number is part of the `/dev` link name used to access the disk. If that number changes during the reconfiguration sequence, the `/dev` link name also changes. This change may affect file system tables and software, such as Solstice DiskSuite™, which use the `/dev` link names. Update `/etc/vfstab` files and execute other administrative actions to change the `/dev` link names.

DR and AP Interaction

DR notifies the AP subsystem when system boards are attached, detached, or placed in the drain state. In addition, DR queries AP about which controllers are in the AP database and their status (active or inactive). This communication occurs between the `dr_daemon(1M)` and `ap_daemon(1M)`. If the `ap_daemon(1M)` is not present, an error message is placed in the `syslog` messages buffer of the domain and DR operations continue without error. To disable this interaction, use the `-a` option when you invoke `dr_daemon(1M)`. See the `dr_daemon(1M)` man page in the *Sun Enterprise 10000 Dynamic Reconfiguration Reference Manual*.

If you are using AP version 2.1, the operating environment automatically switches off the active disk controllers on outgoing boards during the complete-detach phase of DR. If you are using AP version 2.0, you need to manually switch off the active disk controllers before you start the complete-detach phase. For the Solaris 8 operating environment, you must upgrade to AP version 2.3. For more information about DR and AP interaction, see the *Sun Enterprise Servers Alternate Pathing 2.3 User's Guide*. For more information about AP and SDS, refer to the *RAS Companion*.

DR and IDNs

The IDN feature allows domains to communicate to each other over the interconnect by using standard TCP/IP protocols. To provide this capability, the IDN feature maintains detailed information about the hardware configuration and is dependent on the hardware configuration of the member domains.

The DR feature allows the user to reconfigure the hardware while the operating system is running. Thus, DR is required to make an IDN aware of the changes so that the IDN can maintain consistent, up-to-date information about the hardware.

DR accomplishes this requirement by unlinking the domain from the IDN, reconfiguring the hardware, and relinking the domain to the IDN. The unlinking and relinking of the domain occurs during the Complete Attach or Complete Detach phase of the DR operation. DR determines if the domain is a member of an IDN, and it performs the unlinking and relinking of the domain during the Complete phase. No interaction is needed by the user. However, if a member domain is in an unknown state (that is, AWOL), the unlink operation will not succeed, especially if the domain is in a non-responsive state. If one or more domains were in an unknown state when you attempted to perform a DR operation, you must unlink all of the AWOL domains within the IDN in a single step (that is, use the `domain_unlink(1M)` command with all of the names of the AWOL domains).

During the period in which the domain is not linked to the IDN, no transmission to or from the domain are allowed. In contrast, the domain remains a member of the IDN as defined in the `domain_config(4)` file on the SSP, and the domain continues to be listed as a member of the IDN when you use the `domain_status(1M)` command.

Note – Due to the interaction between the DR and IDN features, only one DR or IDN operation is allowed at any given time within a single Sun Enterprise 10000 system.

Certain conditions may require you to use the force option. In the context of a DR operation, you can use the DR force option, which is passed to the `domain_unlink(1M)` command. When used on a domain that is a member of an IDN, the force option should be used with extreme care. See the *Sun Enterprise 10000 Inter-Domain Networks User Guide* for more information about the force option and its use.

RPC Time-Out or Loss of Connection

The `dr_daemon(1M)`, which runs in each domain, communicates with Hostview and the `dr(1M)` shell application (both of which run on the SSP) by way of Remote Procedure Calls (RPCs). If an RPC time-out or connection failure is reported during

a DR operation, check the domain. The daemon must be configured in the `/etc/inetd.conf` file of the domain. The following line (which appears on a single line) must be present in the file:

```
300326/4 tli rpc/tcp wait root \  
/platform/SUNW,Ultra-Enterprise-10000/lib/dr_daemon/ dr_daemon
```

If the DR daemon is configured in `/etc/inetd.conf`, kill the `dr_daemon(1M)` if it is currently running. In addition, send a HUP signal to the `inetd(1M)` daemon to cause it to re-read the `inetd.conf(4)` configuration file:

```
# kill dr_daemon_pid  
# kill -HUP inetd_pid
```

In the first command, `dr_daemon_pid` is the process ID of the DR daemon. In the second command, `inetd_pid` is the process ID of the `inetd(1M)` daemon. You can check `/var/adm/messages` for possible error messages from `inetd(1M)` if it is having trouble starting the `dr_daemon(1M)`. The DR daemon executable file should exist in the `/platform/SUNW,Ultra-Enterprise-10000/lib` directory.

At this point, try the DR operation again, starting from the beginning.

System Quiescence Operation

During a DR Detach operation on a system board with nonpageable OBP or kernel memory, the operating environment is briefly quiesced; that is, all operating environment and device activity on the domain centerplane must cease during the critical phase of the operation. The quiescence only affects the target domain; other domains in the system are not affected.

Before it can quiesce, the operating environment must temporarily suspend all processes, processors, and device activities. If the operating environment cannot quiesce, it displays its reasons, which may include the following:

- Real-time processes are running in the domain.
- A device that cannot be quiesced by the operating environment (that is, a suspend-unsafe device) is open.

The conditions that cause processes not to suspend are generally temporary in nature. You can retry the operation until the quiescence succeeds.

A quiescent failure due to real-time processes or open suspend-unsafe devices is known as a forcible condition. You have the option of performing either a retry or forced retry. When you force the quiescence, you give the operating environment permission to continue with the quiescence even if forcible conditions are still present.



Caution – Exercise care when using the `force` option.

If a real-time process is running, determine if suspending the process would produce an adverse effect on the functions performed by the process. If not, you can force the operating environment to quiesce. (To force a quiescence, you can either click the `Force` button within Hostview as described in “To Detach a Board With Hostview” on page 32, or enter the `complete_detach` command with the `force` option within the `dr(1M)` shell application. Otherwise, you can abort the operation and try again later.

If any suspend-unsafe device is open and cannot be closed, you can manually suspend the device, and then force the operating environment to quiesce. After the operating environment resumes, you can manually resume the device (see “Suspend-Safe/Suspend-Unsafe Devices” on page 12).

If the operating environment fails to quiesce, pay close attention to the reasons for the failure. If the operating environment encountered a transient condition—a failure to suspend a process—you can try the operation again. If, however, the condition(s) requires your approval (for example, a real-time process is running) or intervention (for example, a suspend-unsafe device is open), you can force the operating environment to quiesce.

Suspend-Safe/Suspend-Unsafe Devices

A suspend-safe device is one that does not access the domain centerplane (for example, it does not access memory or interrupt the system) while the operating environment is quiesced. A driver is considered suspend-safe if it supports operating environment quiescence (suspend/resume) and guarantees that when a suspend request is successfully completed, the device that the driver manages will not attempt to access the domain centerplane, even if the device is open when the suspend request is made. All other I/O devices are suspend-unsafe when open.

Note – At the time of this printing, the drivers released by Sun Microsystems™ that are known to be suspend-safe are `st`, `sd`, `isp`, `esp`, `fas`, `sbus`, `pci`, `pei-pci`, `qfe`, `hme` (SunFastEthernet™), `nf` (NPI-FDDI), `qe` (Quad Ethernet), `le` (Lance Ethernet), the SSA drivers (`soc`, `pln`, and `ssd`), and the Sun StorEdge™ A5000 drivers (`sf`, `socal`, `ses`).

To enable device suspension for the `soc` and `pln` drivers, you must edit the `/etc/system` file so that the `pln_enable_detach_suspend` and `soc_enable_detach_suspend` variables are set to 1, as in the following example:

```
set pln:pln_enable_detach_suspend=1
set soc:soc_enable_detach_suspend=1
```

The operating environment refuses a quiesce request if a suspend-unsafe device is open. If you can manually suspend the device, you can force the operating environment to quiesce. To manually suspend the device, you may have to close the device by killing the processes that have it open, ask users not to use the device, or disconnect the cables. For example, if a device that allows asynchronous unsolicited input is open, you can disconnect its cables prior to quiescing the operating environment, preventing traffic from arriving at the device and the device from accessing the domain centerplane. You can reconnect the cables after the operating environment resumes. If you cannot make a device suspend its access to the domain centerplane, you should not force the operating environment to quiesce. Doing so could cause a domain to crash or hang. Instead, postpone the DR operation until the suspend-unsafe device is no longer open.



Caution – If you attempt a forced quiesce operation while activity is occurring on a suspend-unsafe device, the domain may hang. However, if the domain hangs, it will not affect other domains that are running on the Sun Enterprise 10000 system.

Special Handling for Tape Devices

For the Solaris 8 operating environment, tape devices that are natively supported by Sun Microsystems™ are suspend-safe and detach-safe (see `st(7D)` for a list of natively-supported drives). If a system board that you are detaching contains a natively-supported tape device, you can safely detach the board without suspending the device. If you want to use a tape device that is not natively supported by Sun Microsystems, you can use it, but you should make it detach-safe. To ensure correct input/output and DR operations, you need to make a suitable entry in `/kernel/drv/st.conf` with the `ST_UNLOADABLE (0x0400)` flag set in the entry (see `st(7D)` for more information). After you update `st.conf`, you must reboot the domain to process the new entry.

Special Handling of Sun StorEdge A3000

The Sun StorEdge™ A3000 (formerly known as the RSM Array 2000) has dual controller paths with automatic load balancing and automatic failover. To detach a system board that has one or both of the StorEdge A3000 controllers, the controllers on the board that is being detached must be idle or offline. You can take these controllers offline manually by using the `rm6` or `rdacutil` programs before you attempt to detach the system board.

DR and DDI

Not all drivers support the Sun Enterprise 10000 system Dynamic Reconfiguration (DR) features. To support DR, a driver must be able to perform two basic DDI/DKI (Device Driver Interface/Device Kernel Interface) functions, `DDI_DETACH` and `DDI_SUSPEND/DDI_RESUME`. These two functions impact DR in different ways. The DR driver verifies the support of these entry points within the I/O drivers by verifying the existence of the `D_HOTPLUG` bit in the `flags` field of the `cb_ops` of the I/O drivers.

DR and `DDI_DETACH`

You can detach a system board that hosts a device only if the driver for that device supports the `DDI_DETACH` interface, or is not currently loaded. `DDI_DETACH` provides the ability to detach a particular instance of a driver without impacting other instances that are servicing other devices. A driver that supports `DDI_DETACH` is called *detach-safe*; a driver that does not support `DDI_DETACH` is called *detach-unsafe*.

Detaching a detach-unsafe driver that is loaded involves the following process.

- Stopping all usage of the controller for the detach-unsafe device and all other controllers of the same type on all of the boards in the domain.

Because the detach-unsafe driver must be unloaded, you must stop usage of that controller type on *all* of the system boards in the domain. The remaining controllers can be used again after the DR Detach is complete.
- Using standard Solaris interfaces to manually close and to unload all such drivers on the board.

See `modload(1M)` in the *SunOS Reference Manual*.
- Detaching the system board in the normal fashion.

If you cannot accomplish the above process, you can reboot the domain with the board blacklisted (see `blacklist(4)`), so the board can be removed later.

Note – Many third-party drivers (those purchased from vendors other than Sun Microsystems) do not support the standard Solaris `modunload(1M)` interface. Conditions that invoke the functions occur infrequently during normal operation and the functions are sometimes missing or work improperly. Sun Microsystems suggests that you test these driver functions during the qualification and installation phases of any third-party device.

DR and DDI_SUSPEND/DDI_RESUME

To perform a DR Detach of a board that contains nonpageable memory, the domain must be quiesced. Memory can be detached only when all of the drivers throughout the entire domain (not just on the board being detached) either support the `DDI_SUSPEND/DDI_RESUME` driver interface, or are closed. Drivers that support these DDI functions are called *suspend-safe*; drivers that do not are called *suspend-unsafe*.

The most straightforward way to quiesce a domain is to close any *suspend-unsafe* devices. For each network driver you must execute the `ifconfig(1M)` command with its `down` parameter, then again with its `unplumb` parameter (see `ifconfig(1M)` for more information).

Note – It should be possible to unplumb all network drivers. However, this action is rarely tested in normal environments and may result in driver error conditions. If you use DR, Sun Microsystems suggests that you test these driver functions during the qualification and installation phases of any *suspend-unsafe* device.

If the system refuses to quiesce because a *suspend-unsafe* driver is open, you can force the operating domain to quiesce. Doing so forces the operating environment to permit the detach. Note that, although a detach can be forced to proceed when there are open *suspend-unsafe* devices in the system, it is not possible to force a detach when a *detach-unsafe* device resides on the board and its driver is loaded.

To successfully force the operating environment to quiesce, you must manually quiesce the controller. Procedures to do that, if any, are device-specific. The device must not transfer any data, reference memory, or generate interrupts during the operation. Be sure to test any procedures used to quiesce the controller while it is open prior to executing them on a production system.



Caution – Using the `force` option to quiesce the operating environment, without first successfully quiescing the controller, can result in a domain failure and subsequent reboot.

Using Dynamic Reconfiguration

Attaching a System Board

This section gives a broad overview of the actions that occur when you execute DR Attach. For step-by-step instructions, see “To Attach a Board With Hostview”.

You can attach system boards that are present in the machine, powered on, and not part of an active domain (that is, not being used by an operating environment). These unattached boards may have been hot-swapped into the domain after the domain was booted, blacklisted when the domain was booted, or detached from another domain.

Note – If the system board has been hot-swapped into the domain, you should use the `thermal_config(1M)` command immediately after the board has been powered on.

Prior to attaching a board, diagnostics are run on the board, requiring that at least one processor be present on the board and not be blacklisted. After you have selected an eligible board and a target domain, the DR Attach operation proceeds through two operations: Init Attach and Complete Attach.

Init Attach

During the Init Attach phase, DR diagnoses and configures the selected board, preparing it and its devices for attachment to the operating environment. During this phase, DR performs the following tasks:

- Adds the board to the board list of the target domain in the `domain_config(4)` file on the SSP.
- Runs `hpost -H` on the board to configure it. `hpost(1M)` isolates the board on the Sun Enterprise 10000 system centerplane by placing it into a single-board hardware domain (see `hpost(1M)`).
- Runs `obp_helper -H` which loads `download_helper` to the board, and takes the processors on the board out of reset mode, allowing them to spin in `download_helper`.
- Reconfigures the centerplane and board domain mask registers, placing the board in the target hardware domain.

DR displays the output of these `hpost(1M)` and `obp_helper(1M)` operations, including the steps that succeeded and those that caused exceptions.

If `hpost(1M)` and `obp_helper(1M)` succeed, the operating system is notified and requests OBP to probe the board. The operating environment then scans the OBP device tree and adds the devices to its configuration, but the drivers are not loaded.

After the Init Attach phase is completed, the OBP board configuration can be displayed to confirm which devices are present on the board. You can then enter the Complete Attach phase, or you can abort the operation.

If you abort the operation, DR removes the board configuration from the operating environment data structures and removes the board from the `domain_config(4)` file, leaving the board in a state where it is not assigned to any domain. The board can then be removed from the system by using hot swap, left in the system unattached, or attached at a later time.

Complete Attach

During the Complete Attach phase, DR attempts to complete the attach operation by making the resources that are hosted by the new system board available to the operating environment. If a problem occurs that prevents the attachment of any device on the board, the `dr_daemon(1M)` (described in the *Sun Enterprise 10000 Dynamic Reconfiguration Reference Manual*) logs that problem in the system message buffer. To determine which devices were successfully attached, display and check the domain configuration for the board.

After a board is successfully attached, you have the option of reconfiguring the I/O devices. See “Reconfiguration After a DR Operation” on page 7 for more information. This operation can take several minutes to complete.

Attach Buttons

When you perform an attach operation using the Hostview GUI (which transparently calls a separate executable: `drview(1M)`), the following buttons appear at various times during the attach process:

- `init attach` – Begins the attach operation (see “Init Attach” on page 17). After the operation has completed successfully, the label on this button changes to `complete`.
- `complete` – Completes the attach operation (see “Complete Attach” on page 18).
- `reconfig` – Automatically reconfigures the device directories in the domain. You may want to run the reconfiguration operation after attaching a board (see “Reconfiguration After a DR Operation” on page 7).
- `abort` – Cancels the attach operation. This button is enabled after the Init Attach operation has been successfully completed (see “Init Attach” on page 17).
- `dismiss` – Terminates the step that is currently in progress, but leaves the board in its current state (Present, Init Attach, In Use). You can remove the DR Attach window by choosing `dismiss` at any point during the attach operation. The `dismiss` button terminates any work being done on the SSP for the attach operation. For example, if `hpost(1M)` is running when you click `dismiss`, that `hpost(1M)` process is terminated. Note that `dismiss` does not terminate work being done on the host by way of RPCs to the `dr_daemon(1M)`. After an RPC is initiated, the host completes the RPC regardless of whether or not the calling program is waiting for the RPC to finish. The host `dr_daemon(1M)` keeps track of the progress of the attach operation. After the Init Attach operation completes successfully, it remembers this state. Therefore, you can dismiss the window, then return to the DR operation later and complete or abort the attach.
- `help` – Accesses online information regarding DR Attach operations.

▼ To Attach a Board With Hostview

Note – Before you perform the following steps, you should read “Attaching a System Board” on page 17.

- 1. From Hostview, select the proper view of the system from the View menu.**
Choose the view that contains the board you want to attach.
- 2. From Hostview, select the board you want to attach.**
- 3. From Hostview, choose Configuration > Board > Attach.**
The Attach Board and Domain Selection window is displayed (FIGURE 3-1 on page 20).

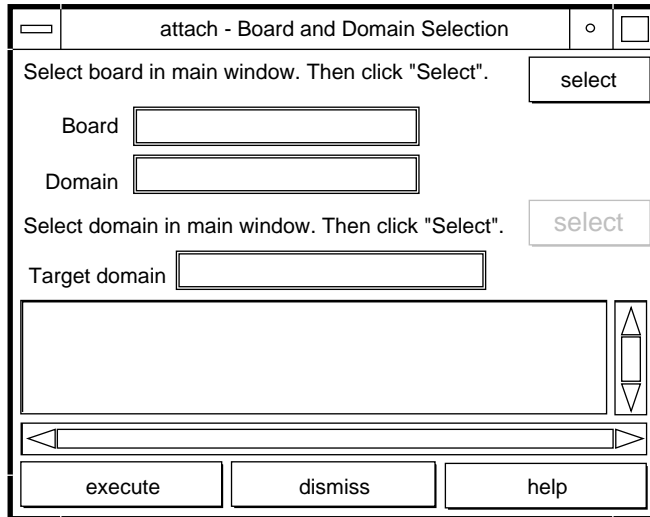

FIGURE 3-1 Attach Board and Domain Selection Window

4. Click the top select button.

The Board field is automatically filled in for you. If the board is part of a domain, the Domain field is also filled in for you. (You can also manually edit these fields.)

5. In the main Hostview window, use the View menu to select the domain to which you want to attach the board.

6. Click the bottom Select button.

The Target Domain field is automatically filled in for you. (You can also manually edit that field.)

7. Click the execute button.

If any errors occur, the error messages appear in the main Hostview window. Otherwise, the Dynamic Reconfiguration window is displayed with the init attach button visible (FIGURE 3-2 on page 21).

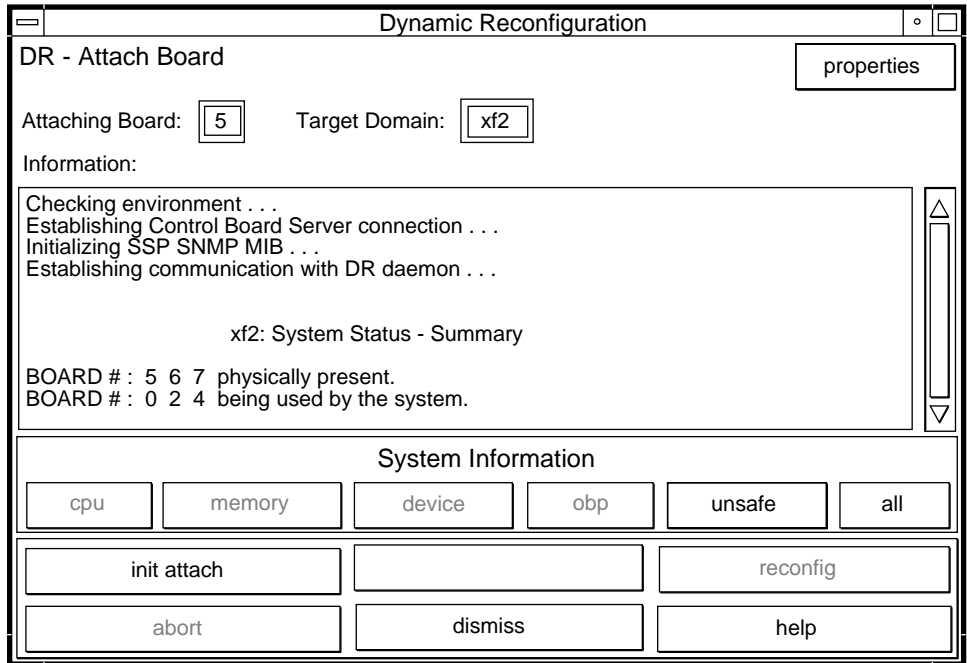

FIGURE 3-2 Dynamic Reconfiguration Window With `init attach` Button

8. Click the `init attach` button.

Clicking on the `init attach` button begins the first phase of the board attach process. First, the system updates the `SSP domain.config(4)` file by adding the system board to the board list of the target domain. Next, the system uses `hpost(1M)` to self-test the system board. After the self-test is complete, the board is made visible to the running target domain by merging it into the hardware domain by modifying the centerplane and the system board hardware registers. Finally, during the conclusion of the `init attach`, OBP probes the new board to discover what CPU, I/O, and memory resources are present on the board. When this phase is finished, the caption on the button changes to `complete`. Before you click the `complete` button, however, you may want to view the domain information to verify that you want to proceed, as described in “Viewing Domain Information” on page 37.

Typically, the `Init Attach` operation can take a few minutes to complete. Output from the `hpost(1M)` command is directed to the Information pane of the Dynamic Reconfiguration window.

If the `Init Attach` fails, look for the cause in the output in the Information pane. After you have determined the cause, you may want to choose `Init Attach` again.

If the `Init Attach` operation completes successfully, the window changes to that shown in FIGURE 3-3 on page 22, with the `complete` button enabled.

9. Click the complete button.

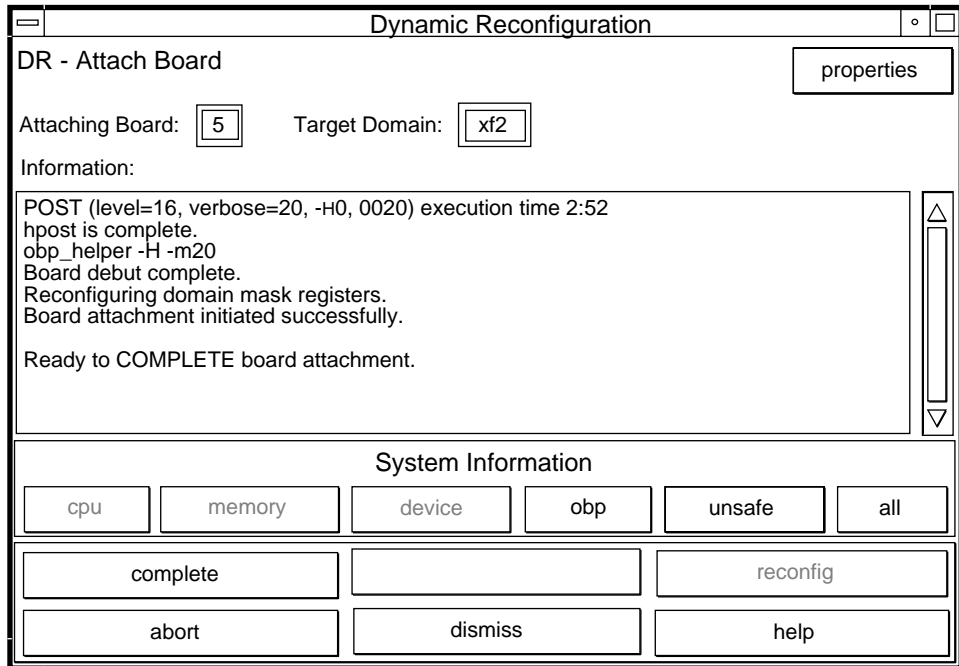

FIGURE 3-3 Dynamic Reconfiguration Window With the complete Button

The complete operation normally takes less than one minute to finish. When it has successfully completed, DR displays the following message:

```
Board attachment completed successfully
```

The system board resources—processors, memory, and I/O devices—are now available to the operating system.

You can view the domain information about the newly attached board by using the buttons (CPU, Memory, Device, and so forth), as described in “Viewing Domain Information” on page 37.



Caution – Before you choose the reconfig button, be sure to read “Reconfiguration After a DR Operation” on page 7.

10. Click the dismiss button.

The DR Attach operation is complete.

▼ To Attach a Board By Using dr(1M)

Note – The following procedure explains how to attach a board by using dr(1M) with SSP version 3.1, or higher. If you are using SSP version 3.0, refer to a previous version of the *Dynamic Reconfiguration User's Guide*.

Before you perform the following steps, read “Attaching a System Board” on page 17. The process of attaching a board is very similar whether you use Hostview or dr(1M). The basic concepts are not repeated in this section.

The dr(1M) shell was introduced in Chapter 1. A quick reference guide is available in the dr(1M) application by using the help command.

1. **Set SUNW_HOSTNAME to the appropriate domain by using the domain_switch(1M) command.**

```
% domain_switch domain_name
```

2. **Use the dr(1M) command in an SSP Window to bring up the dr(1M) prompt.**
In the following example, the target domain is called xf3.

```
% dr
Checking environment...
Establishing Control Board Server connection...
Initializing SSP SNMP MIB...
Establishing communication with DR daemon...

      xf3: Domain Status - Summary

BOARD #: 0 1 2 5 6 8 9 10 11 13 physically present.
BOARD #: 4 7 being used by the domain.
dr>
```

3. Begin the `init_attach(1M)` operation for the designated board.

In this example, board 6 is being attached to `xf3` domain.

```
dr> init_attach 6
Initiate attaching board 6 to domain xf3.
Adding board 6 to domain_config file.
/opt/SUNWssp/bin/hpost -H40,28
Opening SNMP server library...

Significant contents of /export/home/ssp/.postrc:
blacklist_file ./bf
redlist_file ./rf
Reading centerplane asics to obtain bus configuration...
Bus configuration established as 3F.
phase cplane_isolate: CP domain cluster mask clear...
...
phase final_config: Final configuration...
Configuring in 3F, FOM = 2048.00: 4 procs, 4 SCards, 1024 MBytes.
Creating OBP handoff structures...
Configured in 3F with 4 processors, 4 SBus cards, 1024 MBytes
memory.
Interconnect frequency is 83.294 MHz, from SNMP MIB.
Processor frequency is 166.631 MHz, from SNMP MIB.
Boot processor is 6.0 = 24
POST (level=16, verbose=20, -H28,0040) execution time 3:07
hpost is complete.
obp_helper -H -m24
Board debut complete.
Reconfiguring domain mask registers.
Board attachment initiated successfully.

Ready to COMPLETE board attachment.
```

4. Abort or complete the attach operation.

- After the system successfully completes the `init_attach(1M)` operation, you can use the `drshow(1M)` OBP display to see an inventory of the board resources.

```
dr> drshow board_number OBP
```

- If you wish to abort the attach operation, use the `abort_attach(1M)` command.

```
dr> abort_attach board_number
```

- If you wish to complete the board attach operation, use the `complete_attach(1M)` command.

```
dr> complete_attach 6
Completing attach for board 6.
...Checking IDN state of domain_name_a : UP
Issuing IDN UNLINK (domain_name_a)
Verifying IDN UNLINK...
IDN (XM) UNLINK succeeded (domain_name)
...Checking IDN state of domain_name_a : UP
...Checking IDN state of domain_name_b : UP
Initiating IDN LINK...
IDN LINK succeeded (domain_name_a + domain_name_b)
Board attachment completed successfully.
dr>
```

After you successfully attach the board, all of the `drshow(1M)` displays become available.

5. Use the `drshow(1M)` to display the I/O information for the newly attached board.

```
dr> drshow 6 IO

      SBus Controllers and Devices for Board 6

----- Sbus 0 : Slot 0 : SUNW,pln0 -----

device      opens  name                      usage
-----      -
ssd0         0      /dev/dsk/clt0d0s0
ssd16        0      /dev/dsk/clt1d0s0
ssd32        0      /dev/dsk/clt2d0s0
ssd48        0      /dev/dsk/clt3d0s0
ssd64        0      /dev/dsk/clt4d0s0
ssd80        0      /dev/dsk/clt5d0s0

----- Sbus 0 : Slot 1 : SUNW,pln2 -----

device      opens  name                      usage
-----      -
ssd96        0      /dev/dsk/c2t0d0s0
ssd97        0      /dev/dsk/c2t0d1s0
...
```

6. Type `exit` to terminate this `dr(1M)` session.

```
dr> exit
%
```

The SSP login shell prompt is again displayed.

Detaching a System Board

This section gives a broad overview of the actions that occur when you execute DR Detach. For step-by-step instructions, see “To Detach a Board With Hostview” on page 32.

System boards that are currently being used by the operating environment can be detached if they meet the requirements covered in “Configuration for DR Detach” on page 4. After you select an eligible board, you can detach that board by performing two operations: Drain and Complete Detach.

Drain

The primary function of the Drain operation is to determine how the board’s memory is to be vacated by the operating environment and, if required, to select a target memory area for copying the nonpageable memory on a board. If a suitable target memory area is not available when the drain operation is requested, the request is denied. If the drain is rejected for this reason, you can continue to retry until target memory is available. See “Configuration for DR Detach” on page 4.

After the Drain operation is started, the pageable memory on the board is flushed to a disk, which removes it from use by the domain. Whenever a page of memory becomes free, that page is locked from further use. The drain has no noticeable impact on the processes using the CPU and I/O resources on the board. However, less memory is available to the domain.

Note – After memory is drained, enough memory and swap space must remain in the domain to accommodate the current workloads.

During the drain period, Hostview and `dr(1M)` are available to monitor the detach progress. You can view the current status of the drain operation, including the number of memory pages remaining to be drained, and the usage of devices on the board. With this information, you can prepare the domain for detaching the remaining board devices.

If you decide not to proceed with the detach operation, you can abort the operation, and the memory on the board is returned to regular usage. You can also abort the operation during the drain process or after the drain has been completed. If extreme memory pressure exists during the drain, you will see little, or no, progression in the percentage of drained pages, and you may want to abort the drain and wait until the workload on the domain has decreased, enabling it to accommodate the reduction in memory.

The drain operation is complete when all of the memory pages are free from usage. You can then complete the detach operation.

Complete Detach

Before you can complete the detach operation, you must terminate all usage of board resources (processors, memory, and I/O devices). DR terminates the use of memory, processors, and network devices automatically, but you must terminate the use of all non-network I/O devices.

Note – To identify the components that are on the board to be detached, use `drshow(1M)`, which is an option of the `dr(1M)` command, or use the display windows in Hostview (select the Configuration menu and then choose the Board pull-down menu and the Detach menu item). Another somewhat less informative way to identify the components is to use the `prtdiag(1M)` command on the domain.

Network Devices

DR automatically terminates usage of all network interfaces on the board that is being detached. When you complete the detach operation, the `dr_daemon(1M)` identifies all configured interfaces on the board being detached and issues the following `ifconfig(1M)` commands on each such interface.

```
ifconfig interface down
ifconfig interface unplumb
```

Additionally, if FDDI interfaces are detached, DR kills the FDDI network monitoring daemon before you perform the detach operation. DR then restarts it after the detach is complete. Note that the `/usr/sbin/nf_snmd` daemon for `nf` devices is neither started nor stopped when a board that contains a FDDI interface is attached.

DR does not execute these commands on a board that contains a network interface that fits any of the following conditions. In these cases, the detach operation fails and DR displays an error message.

- The interface is the primary network interface for the domain; that is, the interface whose IP address corresponds to the network interface name contained in the file `/etc/nodename`. Note that bringing down the primary network interface for the domain prevents network information name services from operating, which results in the inability to make network connections to remote hosts using applications such as `ftp(1)`, `rsh(1)`, `rcp(1)`, `rlogin(1)`. NFS client and server operations are also affected.
- The interface is on the same subnet as the SSP host for the system; that is, the subnet of the IP address that corresponds to the SSP host name found in `/etc/ssphostname`. Bringing down this interface interrupts communication between the host and SSP. Since DR operations are initiated on the SSP, control of the detach process would be lost. (Note that the `/etc/ssphostname` file contains the name of the SSP that controls the host; therefore, if you rename the SSP, the `/etc/ssphostname` must be manually updated.)
- The interface is the active alternate for an Alternate Pathing (AP) metadvice when the AP metadvice is plumbed. Interfaces used by AP should not be the active path when the board is being detached. AP 2.1 performs the switch automatically; however, you can manually switch the active path to an interface that is not on the board being detached. If no such path exists, manually execute the `ifconfig down` and `ifconfig unplumb` commands on the AP interface. (To manually switch an active path, use the `apconfig(1M)` command.)



Caution – Unmounting network interfaces may affect NFS client systems.

Non-Network Devices

All non-network devices must be closed before they are detached. In the Hostview device display and in the `drshow(1M)` I/O listing, there is an open count field that indicates how many processes have opened particular devices. To see which processes have these devices open, use the `fuser(1M)` command on the domain.

You must perform certain tasks for non-network devices. Although the following list of tasks implies a sequence of order, strict adherence to the order is not necessary.

1. If the redundancy features of Alternate Pathing or Solstice DiskSuite mirroring are used to access a device connected to the board, reconfigure these subsystems so that the device or network is accessible using controllers on other system boards. Note that for Alternate Pathing 2.1, the system automatically switches the disk devices to an alternate interface if one is available.
2. Unmount file systems, including Solstice DiskSuite metadevices that have a board-resident partition (for example, `umount /partit`).
3. Remove Alternate Pathing or Solstice DiskSuite databases from board-resident partitions. The location of Alternate Pathing or Solstice DiskSuite databases is explicitly chosen by the user and can be changed.
4. Remove any private regions used by Sun Enterprise Volume Manager™ or Veritas Volume Manager. Volume manager by default uses a private region on each device that it controls, so such devices must be removed from volume manager control before they can be detached.
5. Remove disk partitions from the swap configuration by using `swap(1M)`.
6. Either kill any process that directly opens a device or raw partition, or direct it to close the open device on the board.
7. If a detach-unsafe device is present on the board, close all instances of the device and use `modunload(1M)` to unload the driver.
8. Kill all of the real-time processes that are open if the operating environment must be suspended.



Caution – Unmounting shared file systems by using the `share(1M)` utility may affect NFS client systems.

Processes

You must perform certain tasks for non-network devices. Although the following list of tasks implies a sequence of order, strict adherence to the order is not necessary.

1. If the operating environment must be suspended, kill all of the real-time processes that are open.
2. Kill any processes that are bound to on-board processors.

When a board is detached, all processes bound to its processors are automatically unbound. You can use `pbind(1M)` to rebind them to other processors.

Processors

The boot processor is responsible for servicing the tick-timer interrupts and for maintaining the netcon BBSRAM buffer. Before detaching a board on which the boot processor resides, the `dr_daemon(1M)` must assign the boot processor role to another active (online) processor.

Finishing the Complete Detach Operation

After all board usage is terminated, you can perform the Complete Detach operation. If a device is still in use at this time, the detach operation fails and the device in use is reported. After you resolve the problem, you can perform the Complete Detach operation again.

If the board that you want to detach contains nonpageable memory, the Complete Detach operation may also fail due to quiescence problems, which are described in “System Quiescence Operation” on page 11. After you resolve the quiescent problem, you can again execute the complete detach operation.

If you decide that you do not want to proceed with the detach operation at this time, you can abort the detach. The memory on a board is returned to normal usage and detached board devices are reattached. If the system configuration was modified to remove board usage (that is, file systems were unmounted and networks were unplumbed), you must undo these modifications and return the devices to normal operation.

After the board is successfully detached from the operating environment, it is isolated from the centerplane. In addition, the board list is automatically updated in the SSP `domain_config(4)` file.

You can now attach the board to another domain, power it off, and remove it by way of hot-swapping, leaving it in the system unattached, or reattaching it at a later time.

Hostview Detach Buttons

The Hostview detach window displays the following buttons at various times during a detach operation:

TABLE 3-1 Hostview Buttons

Button	Description
drain	Drains the memory (see “Drain” on page 26). After the drain operation is finished, the drain button becomes the complete button.
complete	Completes the detach operation after the board has been fully drained (see “Complete Detach” on page 27).
force	Permits you to complete the detach operation by forcibly quiescing the domain (see “System Quiescence Operation” on page 11). If the complete detach operation fails due to a forcible quiesce condition, the force button is enabled.
reconfig	Reconfigures device directories in a domain automatically. You may want to run reconfig after permanently detaching a board. Use reconfig with extreme caution (see “Reconfiguration After a DR Operation” on page 7 for more information).
abort	Cancels the DR operation, and returns the board to normal operation. This button is enabled after the drain operation starts and remains enabled until the complete detach operation starts. To stop the draining of memory and cancel the detach, choose abort (see “Detaching a System Board” on page 26).
dismiss	Cancels any step that is in progress, and leaves the board in its current state (In Use, drain, Present). At any point during the DR Detach operation you can remove the DR Detach window by choosing dismiss which terminates any work being done on the SSP for the detach operation. Note that dismiss does not terminate work being done on the host through RPC calls to the <code>dr_daemon(1M)</code> . After an RPC call is initiated, the host completes the RPC call regardless of whether or not Hostview is waiting for the RPC call to finish. The host <code>dr_daemon(1M)</code> keeps track of the progress of the detach operation. After the drain is started, it remembers this state. Therefore, you can dismiss the window and then return later to either complete or abort the detach operation.
help	Accesses online information regarding DR detach operations.

▼ To Detach a Board With Hostview

Note – Before you execute the following steps, read “Detaching a System Board” on page 26.

1. From the Hostview window, use the View menu to select the domain in which the board is attached.
2. Click the icon of the board you want to detach.
3. From the Hostview menu, choose Configuration > Board > Detach.

The Detach Board and Domain Selection window is displayed (FIGURE 3-4 on page 32).

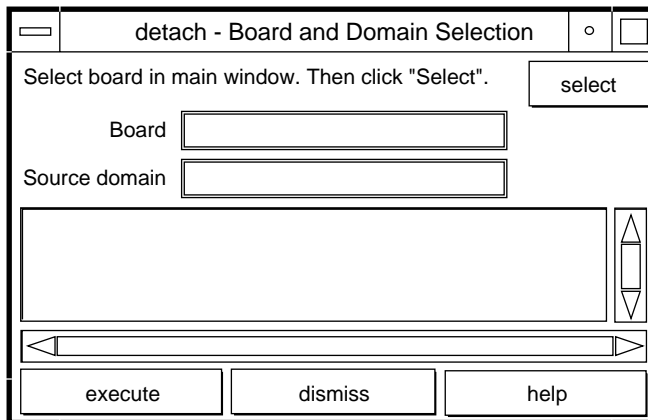

FIGURE 3-4 Detach—Board and Domain Selection Window

4. Click the select button.

The Board and Source domain fields are automatically filled in for you. (You can also manually edit these fields if you wish.)

5. Click the execute button.

If the target domain is not currently booted, the detach operation simply manipulates the domain configuration file on the SSP. However, if the domain is running, the following window is displayed (FIGURE 3-5 on page 33).

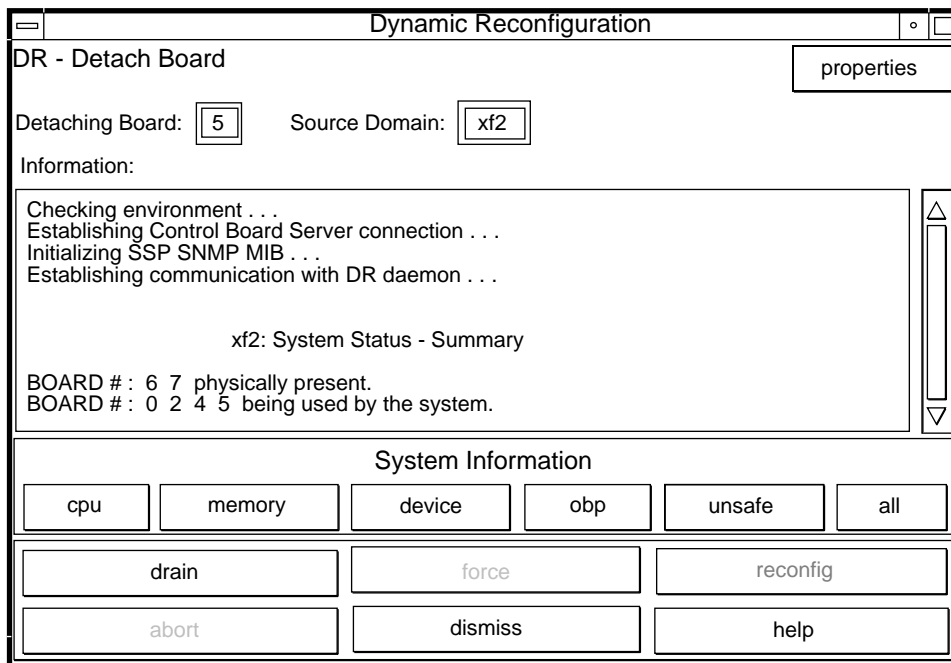

FIGURE 3-5 Dynamic Reconfiguration Window With the drain Button

6. Click the drain button.

Hostview begins draining memory. The memory information is displayed and enables you to monitor the progress of the drain operation.

The memory drain statistics are automatically updated at periodic intervals if you enable the Auto Update Domain Information Displays option in the DR Properties window, as described in “Viewing Domain Information” on page 37.

If the drain operation fails, an explanatory message appears in the Information pane. After you have determined the cause, and corrected it, you can choose drain again.

You may proceed to the next step without waiting; it does not depend on completion of the drain.

7. To determine which devices are active on the board, click the device button.

The DR Device Configuration window is displayed and is periodically updated, providing you with a current snapshot of device usage.

8. Terminate all usage of board-resident I/O devices.

For more information, see “Complete Detach” on page 27.

When the complete button is displayed, DR is finished draining the memory, and you can proceed to the next step.

9. Select the complete button.

This operation may take several minutes to complete, particularly if an operating environment quiescence is necessary. When it is finished, the board devices are detached from the operating system.

If your attempt to complete the detach fails, it may be due to any of the following reasons:

- All online processors in the domain are on the board being detached.
- The board you want to detach contains the last processor in the “default” processor set. You must add an additional processor from another system board before you retry the Detach operation.
- Primary network interfaces are on the board being detached. You must stop all usage of these networks manually (see “Complete Detach” on page 27).
- All usage of the I/O devices on the board you want to detach has not been stopped. The Information pane identifies the device on which the error was encountered (see “Complete Detach” on page 27).
- The operating environment quiescence failed. You must determine and resolve the cause of the error (see “System Quiescence Operation” on page 11).

After you have resolved the reason for the failure, you can select either complete or force to complete the detach. If there are no further problems, the board is detached and reset. When the board is successfully detached, the following message is displayed:

```
Board detachment completed successfully.
```



Caution – Before you choose the reconfig button, you should read “Reconfiguration After a DR Operation” on page 7.

You can now either reconfigure the device directories or dismiss the Detach window. The board can be powered off and removed by hot-swapping, or it can be attached to another domain, left in the system unattached, or reattached at a later time.

▼ To Detach a Board By Using `dr (1M)`

Before you execute the following steps, read “Detaching a System Board” on page 26. The process of detaching a board is very similar with either Hostview or `dr (1M)`. The basic concepts are not repeated in this section. The `dr (1M)` program was introduced in Chapter 1.

1. **Set `SUNW_HOSTNAME` to the appropriate domain using the `domain_switch(1M)` command.**

- 2. Use the `dr(1M)` command in an SSP Window to bring up the `dr(1M)` prompt.**
In the following example, the target domain is called `xf3`.

```
% dr
Checking environment...
Establishing Control Board Server connection...
Initializing SSP SNMP MIB...
Establishing communication with DR daemon...

xf3: Domain Status - Summary

BOARD #: 0 1 2 5 6 8 9 10 11 13 physically present.
BOARD #: 4 7 being used by the domain.
dr>
```

3. Use the `drain(1M)` to drain the board.

```
dr> drain 6
Removing board 6 from domain_config file.
Start draining board 6
Board drain started. Retrieving Domain Info...

    Bound Processes for Board 6

cpu    user  sys  procs
----  -
24     0    1
25     0    1
26     0    1
27     0    1

    Active Devices for Board 6

device    opens  name                usage
-----  -
ssd384    0     /dev/rdisk/c5t0d0s4  AP database

    Memory Drain for Board 6 - IN PROGRESS

Reduction= 1024 MBytes
Remaining in Domain= 1024 MBytes
Percent Complete= 99% (5696 KBytes remaining)

Drain operation started at Wed Oct 09 18:06:00 1996
Current time                Wed Oct 09 18:06:34 1996
Memory Drain is in progress. When Drain has finished,
you may COMPLETE the board detach.

dr>
```

The `drain(1M)` command initiates the drain operation and returns to the shell prompt immediately. You can monitor the progress of the drain operation with the following command:

```
dr> drshow board_number drain
```

Note – In addition, you can initiate the drain with the `wait` option of the `drain(1M)` command, which does not return to the shell prompt until after the drain has completed. Refer to `drain(1M)` for more information regarding the `wait` option.

4. After the drain operation has finished successfully, use the `complete_detach(1M)` command to complete the detach.

```
dr> complete_detach 6
Completing detach of board 6
...Checking IDN state of domain_name_a : UP
Issuing IDN UNLINK (domain_name_a)
Verifying IDN UNLINK...
IDN (XM) UNLINK succeeded (domain_name)
Operating System has detached the board.
Reconfiguring domain mask registers.
...Checking IDN state of domain_name_a : UP
...Checking IDN state of domain_name_b : UP
Initiating IDN LINK...
IDN LINK succeeded (domain_name_a + domain_name_b)
Board 6 placed into loopback.
Board detachment completed successfully.
dr>
```

If the Complete Detach fails with the message “Operating system failed to quiesce due to forcible conditions” and if you have determined the root cause of the quiescent failure, you can retry the `complete_detach` with the `force` option. (You can see the console messages to help determine the cause of the quiescent failure.) Refer to `complete_detach(1M)` for more information.

You can abort the Detach operation, rather than complete it. To do so, use the command `abort_detach board_number`, instead of the `complete_detach` command shown above.

Viewing Domain Information

Both `dr(1M)` and `Hostview` enable you to display information about the suspend-unsafe devices as well as information about the board selected during DR operations. For `dr(1M)`, this information is accessible by using the `drshow(1M)` command. From `Hostview`, this information is available by clicking the `cpu`, `memory`, `device`, `obp`, and `unsafe` buttons in the `attach` or `detach` windows.

Note – You should view and use the domain information *before* you attempt to drain the memory on the board.

The informational content is the same for both `dr(1M)` and `Hostview`. Note that the `cpu`, `memory`, and `device` displays are only enabled when the board is attached to the operating environment. When the `cpu`, `memory`, and `device` displays are available, they always contain accurate information. The `obp` display shows the information known to OBP, but it is not as detailed as the other three displays. This section shows how to use the displays.

▼ To View Domain Information with Hostview

- **Click on any of the System Info buttons during the DR operation** (FIGURE 3-6).

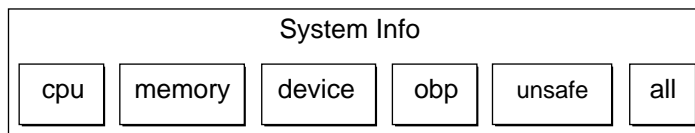

FIGURE 3-6 System Information Buttons

When you click any of these buttons, a window is displayed, and it remains open until you click the dismiss button within that window.

If you click the `All` button, all of the currently enabled windows are displayed.

▼ To Specify How Windows Are Updated

1. **Click the Properties button in the Dynamic Reconfiguration window** (FIGURE 3-7).

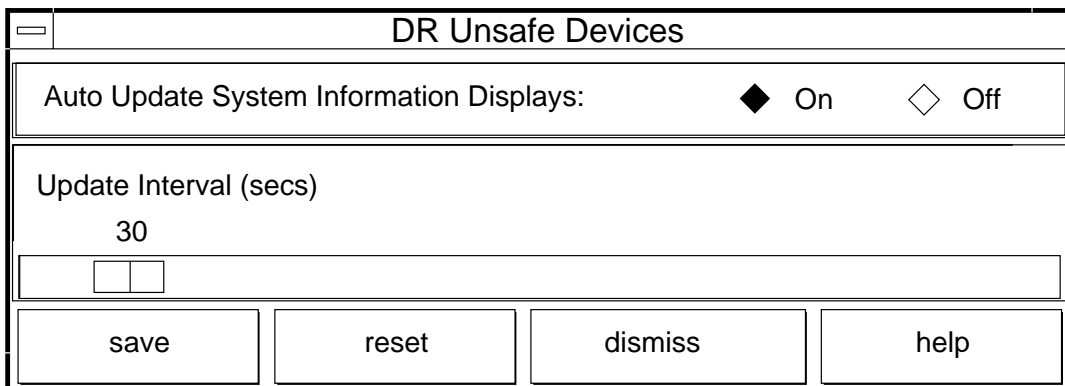

FIGURE 3-7 DR Properties Window

2. **To cause displays to be updated, set Auto Update Domain Information Displays to On (the default).**
3. **Set the Update Interval to a value (in seconds) to determine how often updates occur.**

If you set Auto Update Domain Information Displays to Off, the displays are not updated; each display is a snapshot taken at the time the button was pressed.

4. **Click the Save button to save the settings between Hostview invocations.**

Note – When the update interval is set to a low value, such as 10 seconds, and several information windows are displayed, responsiveness of the DR windows may be degraded. This is especially true when device detail windows are displayed. Each time an information window is updated, an RPC is issued to the `dr_daemon(1M)` running on the domain. The `dr_daemon` is an iterative RPC server, so each RPC request is run sequentially.

▼ To View DR CPU Configuration Information

- **Click the cpu button.**

The DR CPU Configuration window is displayed (FIGURE 3-8).

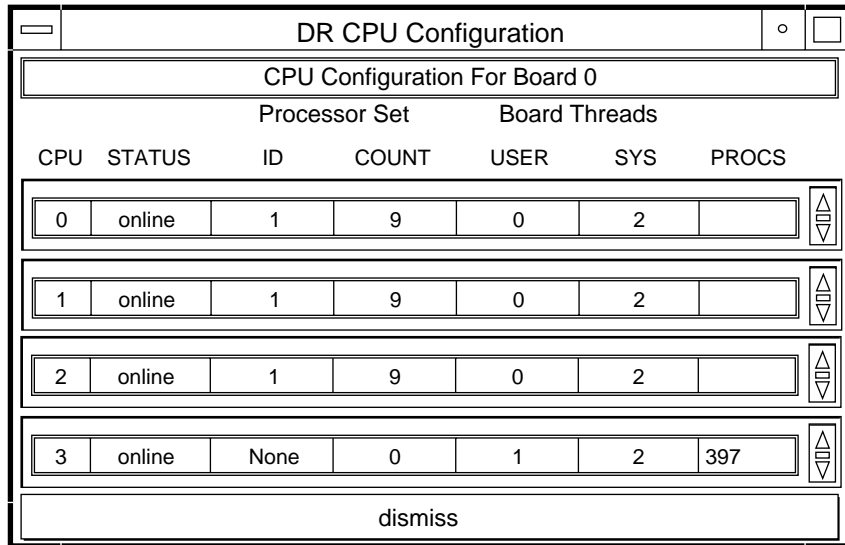

FIGURE 3-8 DR CPU Configuration Window

The DR CPU Configuration window shows specific information about each processor on the selected board.

TABLE 3-2 DR CPU Configuration Information

Heading	Description
CPU ID	Displays the ID number of the selected board.
STATUS	Displays the status of the selected board (that is, whether the board is online or offline).
Processor Set	ID - Displays the ID number of the processor set to which the processor belongs. If the processor belongs to the default set, the word none appears in the box. COUNT - Displays the number of CPUs in the processor set.
Bound Threads	Displays the number of user and system bound threads and the process IDs of the bound threads. Some operating system device drivers may bind threads to processors to provide better servicing of a device. Threads may be bound to a processor by use of the <code>pbind(1M)</code> command.
PROCS	Displays the process IDs of the user processes that are bound to a CPU.

▼ To View DR Memory Configuration Information

- **Click the memory button.**

The DR Memory Configuration window is displayed (FIGURE 3-9).

DR Memory Configuration	
System Memory Sizes (MB)	
Current System:	2048
Attached Capacity:	63488
dr-max-mem:	65536
Memory Detach:	enabled
Memory Configuration for Board 0	
Memory Size(MB):	1024
Interleave Board:	no interleave
Physical Pages:	9437184-9568255
Board contains all pageable memory.	
Memory Drain for Board 0	ESTIMATED
Reduction:	1024
Remaining in System:	1024
Percent Complete:	
Drain Start Time:	
Current Time:	
dismiss	

FIGURE 3-9 DR Memory Configuration Window

The DR Memory Configuration window is divided into three panels:

TABLE 3-3 DR Memory Configuration Information

System Memory Sizes (Domain Memory Information)

Current Domain	Total size of memory in the domain from all boards
Attach Capacity	Amount of memory that can be added by using the DR Attach operation
<code>dr-max-mem</code>	Current value of the OBP variable <code>dr-max-mem</code> (for more information, see “ <code>dr-max-mem</code> Variable” on page 3)

Memory Configuration for Board 0 (Board-Level Information)

Memory Size (MB)	Amount of memory on the selected board
Interleave Board	Board that the selected board is interleaved with
Physical Pages	Highest and lowest physical pages that are occupied by the memory on this board (Small memory areas in the middle of this range may not be used by this board. Note that DR is not able to detach boards that have interleaved memory.)

Status/State (the display depends on the status/state of the operation)

Unavailable	A suitable target memory area is not currently available.
Estimated	The estimated values are displayed prior to starting the drain operation. The values displayed reflect the memory configuration that would result if the drain operation were started at this point. Note that the estimated values may differ from the in-progress values depending on the domain memory usage at the time drain was started.
In Progress	The drain operation is in progress.
Complete	The drain operation is finished.

Memory Drain Information

Reduction	Amount of memory to be removed from domain usage when the board is detached
Remaining in Domain	Domain memory size after the board is detached

TABLE 3-3 DR Memory Configuration Information (*Continued*)

Percent Complete	How far the drain operation has progressed. Note that the time required to drain each memory page is not constant. Some memory pages take longer to drain than others.
Drain Start Time	The time the drain operation was started.
Current Time	The current time, which can be compared to the drain start time to see how long the drain operation has been in progress.

▼ To View DR Device Configuration Information

- **Click the device button.**

The DR Device Configuration window is displayed (FIGURE 3-10).

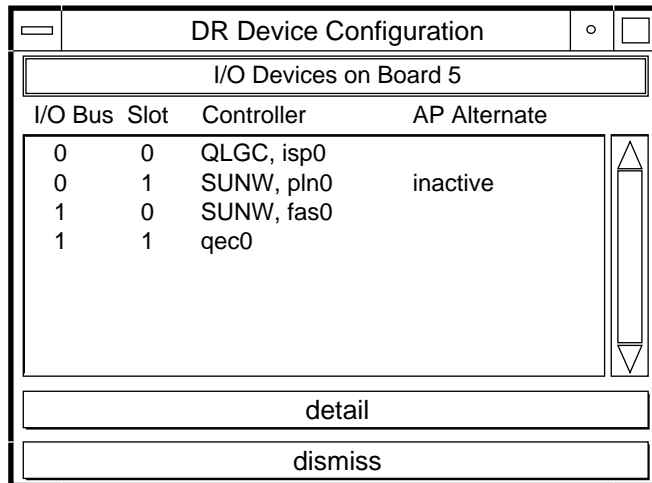

FIGURE 3-10 DR Device Configuration Window

The controllers or devices in each slot are listed. The controller and device names are a concatenation of their device name and their operating environment instance number (for example, `sd31`).

Note – The DR Device Configuration window may not show all of the devices that are physically present on the board. For example, controllers whose drivers are unattached do not appear in the list. The device display that is available by using the `obp` button lists the cards on the board that were successfully probed and identified.

▼ To View DR Device Detailed Information

1. **Highlight one or more controller(s).**
2. **Choose Detail.**

The following window is displayed for each selected controller (FIGURE 3-11).

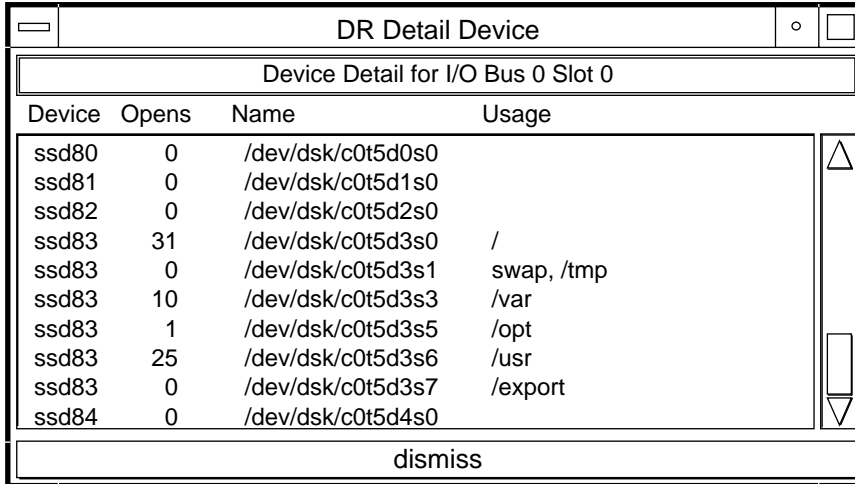

The screenshot shows a window titled "DR Detail Device" with a subtitle "Device Detail for I/O Bus 0 Slot 0". The window contains a table with the following data:

Device	Opens	Name	Usage
ssd80	0	/dev/dsk/c0t5d0s0	
ssd81	0	/dev/dsk/c0t5d1s0	
ssd82	0	/dev/dsk/c0t5d2s0	
ssd83	31	/dev/dsk/c0t5d3s0	/
ssd83	0	/dev/dsk/c0t5d3s1	swap, /tmp
ssd83	10	/dev/dsk/c0t5d3s3	/var
ssd83	1	/dev/dsk/c0t5d3s5	/opt
ssd83	25	/dev/dsk/c0t5d3s6	/usr
ssd83	0	/dev/dsk/c0t5d3s7	/export
ssd84	0	/dev/dsk/c0t5d4s0	

At the bottom of the window is a "dismiss" button.

FIGURE 3-11 DR Detail Device Window

The current usage information for each device is shown. The window includes an open count (if available) and the common name (for example, a disk partition, a metadvice, or an interface name) by which the device is known. Additional usage information is also provided, including the partition mount points, network interface configuration, swap space usage, and metadvice usage.

Note – Some device usage, such as disk partitions used for Sun Solstice DiskSuite databases, Alternate Pathing databases, and Sun Enterprise Volume Manager usage, may not be reported.

If a controller or network interface is part of the AP database, the window indicates that it is active or that it is an AP alternate. For active AP alternates, the usage of the AP metadvice is displayed.

▼ To View DR OBP Configuration Information

Note – The information in the DR OBP Configuration window is derived from the OBP device tree, and is less detailed than the information that is available from the other windows described in this section. For example, in the init attach state, only the I/O adapters are known—not the devices attached to those controllers nor the memory interleave configuration. This window is usually used when a board is in the init attach state.

- **Click the obp button.**

The DR OBP Configuration window is displayed (FIGURE 3-12).

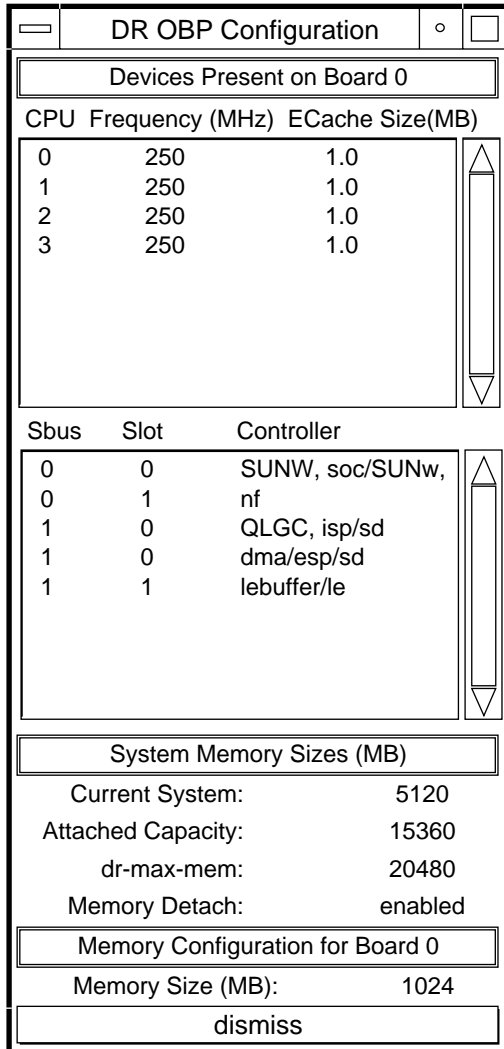

FIGURE 3-12 DR OBP Configuration Window

▼ To View the DR-Unsafe Devices

- **Click the unsafe button.**

The DR Unsafe Devices window is displayed (FIGURE 3-13).

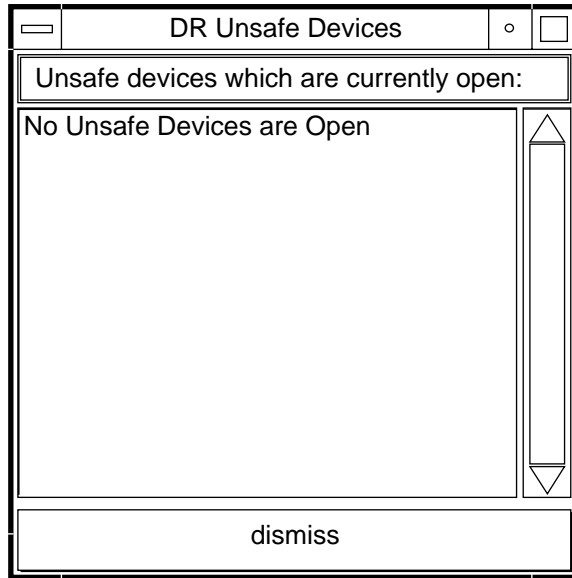

FIGURE 3-13 DR Unsafe Devices Window

The DR Unsafe Devices window shows the suspend-unsafe devices that are open across the entire domain, not just those that are resident on the selected system board. This information is useful for determining the cause of operating environment quiescence errors due to unsafe devices being open.

DR Error Messages

This appendix contains a list of some of the error messages that you might see while you are performing DR operations. The list does not include Protocol Independent Module (PIM) layer errors, which are more generic than the error messages in the following tables.

All DR error messages are sent to the one or both of the following locations:

- SSP applications
- System error logs

Searching This Appendix

Before you use this appendix, take time to read the following list of search tips so that you can find a specific message.

- Search on a specific string of text in the error message.
- Avoid using numeric values. They are treated as replaceable text in this appendix.
- Avoid using text that is replaceable. In this appendix, the following names are used to represent replaceable text in the error messages: *descriptive message*, *errno_description*, *device_name*, *target_path*, *mount_point*, *interface_name_instance*, *interface_name*, and *partition_name*.
- If you are reading this text in hard-copy form, the tables are presented in order by the type of error or failure. The contents of the tables is sorted alphabetically in descending order.

Error-Type Links

Use one of the following links to start your search.

- “DR Daemon Start-Up Errors” on page 50
- “Memory Allocation Error Messages” on page 52
- “DR Driver Failures” on page 59
- “PSM Error Messages” on page 61
- “General Failures” on page 63
- “Protocol and Communication Error Messages” on page 65
- “Attach-Related Failures” on page 70
- “Detach-Related Error Messages” on page 72
- “Auto-Configuration Error Messages” on page 77
- “System Exploration Error Messages” on page 79
- “OpenBoot PROM Error Messages” on page 93
- “Unsafe-Device Query Failures” on page 96
- “AP-Related Error Messages” on page 98

DR Daemon Start-Up Errors

The following table contains a list of the DR daemon start-up errors. These messages are sent only to the domain console window.

TABLE A-1 DR Daemon Start-Up Error Messages

Error Message	Probable Cause	Suggested Action
Cannot create server handle	The DR daemon could not start up the RPC server. You will see this message only if you manually execute the DR daemon without properly configuring the network services on the domain. Normally, network services spawn the DR daemon in response to an incoming RPC from the SSP.	On the domain, fix the <code>inetd.conf</code> entry for the DR daemon.

TABLE A-1 DR Daemon Start-Up Error Messages

Error Message	Probable Cause	Suggested Action
Cannot fork: <i>descriptive message</i>	The DR daemon could not fork a process from which to run its RPC server.	The descriptive error message corresponds to an <i>errno_value</i> and offers clues as to why the DR daemon could not fork off the RPC server. Check the resource limits and the load of the system to find a way to fix this error.
Permission denied	A user other than root tried to run the DR daemon.	Only the superuser (root) can run the DR daemon because the daemon needs all of the root privileges to fully explore the system and to access the driver to detach and attach boards.
Unable to register (300326, 4)	The DR daemon was executed without being properly registered with the network services in the domain. The first number represents the RPC number that is registered for the DR daemon. The second number represents the RPC version used by the DR daemon.	On the domain, fix the <code>inetd.conf</code> entry for the DR daemon.
Unable to create (300326, 4) for netpath	The DR daemon was executed without being properly registered with the network services in the domain. The first number represents the RPC number that is registered for the DR daemon. The second number represents the RPC version used by the DR daemon.	On the domain, fix the <code>inetd.conf</code> entry for the DR daemon.

Memory Allocation Error Messages

The following table contains the memory allocation error messages that are sent to the system logs and to the SSP applications. Although the list contains several error messages, each of them describe one of two possible errors: `ENOMEM` or `EAGAIN`. All of the `ENOMEM` errors have the same suggested action, as do the `EAGAIN` errors.

TABLE A-2 Memory Allocation Error Messages

Error Message	Probable Cause	Suggested Action
DR Error: malloc failed (add notnet ap info) <i>errno_description</i>	While it queried the system information, the DR daemon could not allocate enough memory for a structure in which to return the requested information. The daemon may have encountered a resource limit. If the DR daemon cannot allocate memory, then it cannot continue to work. The <i>errno_description</i> usually describes an <code>ENOMEM</code> or <code>EAGAIN</code> error.	First, check the size of the daemon by using the <code>ps(1)</code> command. Normally, the daemon uses about 300- to 400-Kbytes of memory. If the daemon is larger than the above memory sizes, then it may have a memory leak. If it does, you should report this problem. An <code>ENOMEM</code> error means that the DR daemon is in a state from which it cannot recover. An <code>EAGAIN</code> error means that the problem may have been temporary. You can retry the operation, which may succeed eventually, or you may have to stop and restart the daemon.
DR Error: malloc failed (alias_namelen) <i>errno_description</i>	While it queried the system information, the DR daemon could not allocate enough memory for a structure in which to return the requested information. The daemon may have encountered a resource limit. If the DR daemon cannot allocate memory, then it cannot continue to work. The <i>errno_description</i> usually describes an <code>ENOMEM</code> or <code>EAGAIN</code> error.	First, check the size of the daemon by using the <code>ps(1)</code> command. Normally, the daemon uses about 300- to 400-Kbytes of memory. If the daemon is larger than the above memory sizes, then it may have a memory leak. If it does, you should report this problem. An <code>ENOMEM</code> error means that the DR daemon is in a state from which it cannot recover. An <code>EAGAIN</code> error means that the problem may have been temporary. You can retry the operation, which may succeed eventually, or you may have to stop and restart the daemon.

TABLE A-2 Memory Allocation Error Messages (Continued)

Error Message	Probable Cause	Suggested Action
DR Error: malloc failed (AP_ctrl_t array) <i>errno_description</i>	While it queried the system information, the DR daemon could not allocate enough memory for a structure in which to return the requested information. The daemon may have encountered a resource limit. If the DR daemon cannot allocate memory, then it cannot continue to work. The <i>errno_description</i> usually describes an ENOMEM or EAGAIN error.	First, check the size of the daemon by using the ps(1) command. Normally, the daemon uses about 300- to 400-Kbytes of memory. If the daemon is larger than the above memory sizes, then it may have a memory leak. If it does, you should report this problem. An ENOMEM error means that the DR daemon is in a state from which it cannot recover. An EAGAIN error means that the problem may have been temporary. You can retry the operation, which may succeed eventually, or you may have to stop and restart the daemon.
DR Error: malloc failed (ap_controller) <i>errno_description</i>	While it queried the system information, the DR daemon could not allocate enough memory for a structure in which to return the requested information. The daemon may have encountered a resource limit. If the DR daemon cannot allocate memory, then it cannot continue to work. The <i>errno_description</i> usually describes an ENOMEM or EAGAIN error.	First, check the size of the daemon by using the ps(1) command. Normally, the daemon uses about 300- to 400-Kbytes of memory. If the daemon is larger than the above memory sizes, then it may have a memory leak. If it does, you should report this problem. An ENOMEM error means that the DR daemon is in a state from which it cannot recover. An EAGAIN error means that the problem may have been temporary. You can retry the operation, which may succeed eventually, or you may have to stop and restart the daemon.
DR Error: malloc failed (board_cpu_config_t) <i>errno_description</i>	While it queried the system information, the DR daemon could not allocate enough memory for a structure in which to return the requested information. The daemon may have encountered a resource limit. If the DR daemon cannot allocate memory, then it cannot continue to work. The <i>errno_description</i> usually describes an ENOMEM or EAGAIN error.	First, check the size of the daemon by using the ps(1) command. Normally, the daemon uses about 300- to 400-Kbytes of memory. If the daemon is larger than the above memory sizes, then it may have a memory leak. If it does, you should report this problem. An ENOMEM error means that the DR daemon is in a state from which it cannot recover. An EAGAIN error means that the problem may have been temporary. You can retry the operation, which may succeed eventually, or you may have to stop and restart the daemon.

TABLE A-2 Memory Allocation Error Messages (Continued)

Error Message	Probable Cause	Suggested Action
DR Error: malloc failed (board_mem_config_t) <i>errno_description</i>	While it queried the system information, the DR daemon could not allocate enough memory for a structure in which to return the requested information. The daemon may have encountered a resource limit. If the DR daemon cannot allocate memory, then it cannot continue to work. The <i>errno_description</i> usually describes an ENOMEM or EAGAIN error.	First, check the size of the daemon by using the ps(1) command. Normally, the daemon uses about 300- to 400-Kbytes of memory. If the daemon is larger than the above memory sizes, then it may have a memory leak. If it does, you should report this problem. An ENOMEM error means that the DR daemon is in a state from which it cannot recover. An EAGAIN error means that the problem may have been temporary. You can retry the operation, which may succeed eventually, or you may have to stop and restart the daemon.
DR Error: malloc failed (board_mem_cost_t) <i>errno_description</i>	While it queried the system information, the DR daemon could not allocate enough memory for a structure in which to return the requested information. The daemon may have encountered a resource limit. If the DR daemon cannot allocate memory, then it cannot continue to work. The <i>errno_description</i> usually describes an ENOMEM or EAGAIN error.	First, check the size of the daemon by using the ps(1) command. Normally, the daemon uses about 300- to 400-Kbytes of memory. If the daemon is larger than the above memory sizes, then it may have a memory leak. If it does, you should report this problem. An ENOMEM error means that the DR daemon is in a state from which it cannot recover. An EAGAIN error means that the problem may have been temporary. You can retry the operation, which may succeed eventually, or you may have to stop and restart the daemon.
DR Error: malloc failed (board_mem_drain_t) <i>errno_description</i>	While it queried the system information, the DR daemon could not allocate enough memory for a structure in which to return the requested information. The daemon may have encountered a resource limit. If the DR daemon cannot allocate memory, then it cannot continue to work. The <i>errno_description</i> usually describes an ENOMEM or EAGAIN error.	First, check the size of the daemon by using the ps(1) command. Normally, the daemon uses about 300- to 400-Kbytes of memory. If the daemon is larger than the above memory sizes, then it may have a memory leak. If it does, you should report this problem. An ENOMEM error means that the DR daemon is in a state from which it cannot recover. An EAGAIN error means that the problem may have been temporary. You can retry the operation, which may succeed eventually, or you may have to stop and restart the daemon.

TABLE A-2 Memory Allocation Error Messages (Continued)

Error Message	Probable Cause	Suggested Action
DR Error: malloc failed (dr_io) <i>errno_description</i>	While it queried the system information, the DR daemon could not allocate enough memory for a structure in which to return the requested information. The daemon may have encountered a resource limit. If the DR daemon cannot allocate memory, then it cannot continue to work. The <i>errno_description</i> usually describes an ENOMEM or EAGAIN error.	First, check the size of the daemon by using the ps(1) command. Normally, the daemon uses about 300- to 400-Kbytes of memory. If the daemon is larger than the above memory sizes, then it may have a memory leak. If it does, you should report this problem. An ENOMEM error means that the DR daemon is in a state from which it cannot recover. An EAGAIN error means that the problem may have been temporary. You can retry the operation, which may succeed eventually, or you may have to stop and restart the daemon.
DR Error: malloc failed (leaf array) <i>errno_description</i>	While it queried the system information, the DR daemon could not allocate enough memory for a structure in which to return the requested information. The daemon may have encountered a resource limit. If the DR daemon cannot allocate memory, then it cannot continue to work. The <i>errno_description</i> usually describes an ENOMEM or EAGAIN error.	First, check the size of the daemon by using the ps(1) command. Normally, the daemon uses about 300- to 400-Kbytes of memory. If the daemon is larger than the above memory sizes, then it may have a memory leak. If it does, you should report this problem. An ENOMEM error means that the DR daemon is in a state from which it cannot recover. An EAGAIN error means that the problem may have been temporary. You can retry the operation, which may succeed eventually, or you may have to stop and restart the daemon.
DR Error: malloc failed (leaf) <i>errno_description</i>	While it queried the system information, the DR daemon could not allocate enough memory for a structure in which to return the requested information. The daemon may have encountered a resource limit. If the DR daemon cannot allocate memory, then it cannot continue to work. The <i>errno_description</i> usually describes an ENOMEM or EAGAIN error.	First, check the size of the daemon by using the ps(1) command. Normally, the daemon uses about 300- to 400-Kbytes of memory. If the daemon is larger than the above memory sizes, then it may have a memory leak. If it does, you should report this problem. An ENOMEM error means that the DR daemon is in a state from which it cannot recover. An EAGAIN error means that the problem may have been temporary. You can retry the operation, which may succeed eventually, or you may have to stop and restart the daemon.

TABLE A-2 Memory Allocation Error Messages (Continued)

Error Message	Probable Cause	Suggested Action
DR Error: malloc failed (net_leaf_array) <i>errno_description</i>	While it queried the system information, the DR daemon could not allocate enough memory for a structure in which to return the requested information. The daemon may have encountered a resource limit. If the DR daemon cannot allocate memory, then it cannot continue to work. The <i>errno_description</i> usually describes an ENOMEM or EAGAIN error.	First, check the size of the daemon by using the ps(1) command. Normally, the daemon uses about 300- to 400-Kbytes of memory. If the daemon is larger than the above memory sizes, then it may have a memory leak. If it does, you should report this problem. An ENOMEM error means that the DR daemon is in a state from which it cannot recover. An EAGAIN error means that the problem may have been temporary. You can retry the operation, which may succeed eventually, or you may have to stop and restart the daemon.
DR Error: malloc failed (sbus_cntrl_t) <i>errno_description</i>	While it queried the system information, the DR daemon could not allocate enough memory for a structure in which to return the requested information. The daemon may have encountered a resource limit. If the DR daemon cannot allocate memory, then it cannot continue to work. The <i>errno_description</i> usually describes an ENOMEM or EAGAIN error.	First, check the size of the daemon by using the ps(1) command. Normally, the daemon uses about 300- to 400-Kbytes of memory. If the daemon is larger than the above memory sizes, then it may have a memory leak. If it does, you should report this problem. An ENOMEM error means that the DR daemon is in a state from which it cannot recover. An EAGAIN error means that the problem may have been temporary. You can retry the operation, which may succeed eventually, or you may have to stop and restart the daemon.
DR Error: malloc failed (sbus_config) <i>errno_description</i>	While it queried the system information, the DR daemon could not allocate enough memory for a structure in which to return the requested information. The daemon may have encountered a resource limit. If the DR daemon cannot allocate memory, then it cannot continue to work. The <i>errno_description</i> usually describes an ENOMEM or EAGAIN error.	First, check the size of the daemon by using the ps(1) command. Normally, the daemon uses about 300- to 400-Kbytes of memory. If the daemon is larger than the above memory sizes, then it may have a memory leak. If it does, you should report this problem. An ENOMEM error means that the DR daemon is in a state from which it cannot recover. An EAGAIN error means that the problem may have been temporary. You can retry the operation, which may succeed eventually, or you may have to stop and restart the daemon.

TABLE A-2 Memory Allocation Error Messages (Continued)

Error Message	Probable Cause	Suggested Action
DR Error: malloc failed (sbus_device_t) <i>errno_description</i>	While it queried the system information, the DR daemon could not allocate enough memory for a structure in which to return the requested information. The daemon may have encountered a resource limit. If the DR daemon cannot allocate memory, then it cannot continue to work. The <i>errno_description</i> usually describes an ENOMEM or EAGAIN error.	First, check the size of the daemon by using the ps(1) command. Normally, the daemon uses about 300- to 400-Kbytes of memory. If the daemon larger than the above memory sizes, then it may have a memory leak. If it does, you should report this problem. An ENOMEM error means that the DR daemon is in a state from which it cannot recover. An EAGAIN error means that the problem may have been temporary. You can retry the operation, which may succeed eventually, or you may have to stop and restart the daemon.
DR Error: malloc failed (sbus_usage_t) <i>errno_description</i>	While it queried the system information, the DR daemon could not allocate enough memory for a structure in which to return the requested information. The daemon may have encountered a resource limit. If the DR daemon cannot allocate memory, then it cannot continue to work. You may have to stop and restart the daemon. The <i>errno_description</i> usually describes an ENOMEM or EAGAIN error.	First, check the size of the daemon by using the ps(1) command. Normally, the daemon uses about 300- to 400-Kbytes of memory. If the daemon is larger than the above memory sizes, then it may have a memory leak. If it does, you should report this problem. An ENOMEM error means that the DR daemon is in a state from which it cannot recover. An EAGAIN error means that the problem may have been temporary. You can retry the operation, which may succeed eventually, or you may have to stop and restart the daemon.
DR Error: malloc failed (struct devnm) <i>errno_description</i>	While it queried the system information, the DR daemon could not allocate enough memory for a structure in which to return the requested information. The daemon may have encountered a resource limit. If the DR daemon cannot allocate memory, then it cannot continue to work. The <i>errno_description</i> usually describes an ENOMEM or EAGAIN error.	First, check the size of the daemon by using the ps(1) command. Normally, the daemon uses about 300- to 400-Kbytes of memory. If the daemon larger than the above memory sizes, then it may have a memory leak. If it does, you should report this problem. An ENOMEM error means that the DR daemon is in a state from which it cannot recover. An EAGAIN error means that the problem may have been temporary. You can retry the operation, which may succeed eventually, or you may have to stop and restart the daemon.

TABLE A-2 Memory Allocation Error Messages (Continued)

Error Message	Probable Cause	Suggested Action
DR Error: malloc failed (swap name entries) <i>errno_description</i>	While it queried the system information, the DR daemon could not allocate enough memory for a structure in which to return the requested information. The daemon may have encountered a resource limit. If the DR daemon cannot allocate memory, then it cannot continue to work. The <i>errno_description</i> usually describes an ENOMEM or EAGAIN error.	First, check the size of the daemon by using the <code>ps(1)</code> command. Normally, the daemon uses about 300- to 400-Kbytes of memory. If the daemon larger than the above memory sizes, then it may have a memory leak. If it does, you should report this problem. An ENOMEM error means that the DR daemon is in a state from which it cannot recover. An EAGAIN error means that the problem may have been temporary. You can retry the operation, which may succeed eventually, or you may have to stop and restart the daemon.
DR Error: malloc failed (swaptbl) <i>errno_description</i>	While it queried the system information, the DR daemon could not allocate enough memory for a structure in which to return the requested information. The daemon may have encountered a resource limit. If the DR daemon cannot allocate memory, then it cannot continue to work. The <i>errno_description</i> usually describes an ENOMEM or EAGAIN error.	First, check the size of the daemon by using the <code>ps(1)</code> command. Normally, the daemon uses about 300- to 400-Kbytes of memory. If the daemon is larger than the above memory sizes, then it may have a memory leak. If it does, you should report this problem. An ENOMEM error means that the DR daemon is in a state from which it cannot recover. An EAGAIN error means that the problem may have been temporary. You can retry the operation, which may succeed eventually, or you may have to stop and restart the daemon.
DR Error: malloc failed (unsafe_devs) <i>errno_description</i>	While it queried the system information, the DR daemon could not allocate enough memory for a structure in which to return the requested information. The daemon may have encountered a resource limit. If the DR daemon cannot allocate memory, then it cannot continue to work. The <i>errno_description</i> usually describes an ENOMEM or EAGAIN error.	First, check the size of the daemon by using the <code>ps(1)</code> command. Normally, the daemon uses about 300- to 400-Kbytes of memory. If the daemon larger than the above memory sizes, then it may have a memory leak. If it does, you should report this problem. An ENOMEM error means that the DR daemon is in a state from which it cannot recover. An EAGAIN error means that the problem may have been temporary. You can retry the operation, which may succeed eventually, or you may have to stop and restart the daemon.

DR Driver Failures

The following table contains the DR driver failures that are sent to the system logs and to the SSP applications. In general, refer to the descriptions of the daemon and PSM errors for details about what goes to the system logs and what goes to the SSP.

Note – All of the possible DR driver failure messages are related to the three probable causes given in the table. Likewise, all of the failure messages have one suggested action.

TABLE A-3 Memory Allocation Error Messages

Error Message	Probable Cause	Suggested Action
DR: Error: initiate_attach: ioctl failed	An ioctl failure (that is, a failure that was encountered by the DR daemon when it tried to use the DR driver) can occur at three separate levels.	The context of the <code>ioctl()</code> failure (that is, which function precedes the <code>ioctl()</code> failed portion of the message), combined with the text of the error message, indicates what failed. Use the error number to identify the probable cause by checking the information on the <code>ioctl(2)</code> man page. You can also use the <code>/usr/include/errno.h</code> header file if the <code>ioctl(2)</code> man page does not have a specific reference for the error number.
DR: Error: complete_attach: ioctl failed	At the first level—within the DR daemon, occur when the DR daemon and the DR driver are not interacting properly. The driver could be missing; the DR driver files in the <code>/devices/pseudo</code> directory could be missing, or the file permissions could be wrong.	
DR: Error: abort_attach: ioctl failed	The DR daemon could also be experiencing memory corruption or resource limitations. The <code>ioctl</code> failure message is followed by a message in the form: <code>Daemon (errno #error_number): error description.</code>	
DR: Error: get_cpu_info: ioctl failed		
DR: Error: get_mem_config: ioctl failed		

TABLE A-3 Memory Allocation Error Messages (Continued)

Error Message	Probable Cause	Suggested Action
DR: Error: get_mem_cost: ioctl failed	At the second level—within the platform independent module (PIM) layer of the DR driver, an ioctl failure could indicate busy resources, failing I/O devices on the system board, or	See above.
DR: Error: get_mem_drain: ioctl failed	improper interaction between the PIM and the platform specific module (PSM) layers. The ioctl failure message is followed by a PIM message in the form: PIM (error #errornumber):	
DR: Error: update_attach: ioctl failed	<i>errno_description.</i>	
DR: Error: ioctl failed, error draining resources	At the third level—the PSM layer, an ioctl failure could indicate busy resources, failing I/O devices on the system board, memory detach failures, CPU detach failures, or internal	
DR: Error: detach_board: UNCONFIGURE ioctl failed	failures encountered by the PSM driver. The error description usually cites specific physical devices that are failing or includes detailed	
DR: Error: detach_board: DISCONNECT ioctl failed	explanations for a memory or CPU detachment failure. The ioctl failure message is followed by a PSM message appears in the following form: PSM (error #errornumber):	
DR: Error: abort_detach: CANCEL ioctl failed	<i>errno_description.</i>	
DR: Error: abort_detach: CONFIGURE ioctl failed	Note that failures in the PSM layer do not have corresponding errno values. PSM failure messages use an error number. You can find explanations of the error numbers in the <code>/usr/include/sys/sfdr.h</code> header file.	
DR: Error: get_dr_state: ioctl failed		
DR: Error: get_dr_status: ioctl failed		

PSM Error Messages

The following table contains a list of PSM error messages that are sent to the system logs and to the SSP applications.

TABLE A-4 PSM Error Messages

Error Message	Probable Cause	Suggested Action
1 SFDR_ERR_INTERNAL	An internal driver failed.	None
2 SFDR_ERR_SUSPEND	Failed to suspend devices.	None
3 SFDR_ERR_RESUME	Failed to resume suspended devices.	None
4 SFDR_ERR_UNSAFE	Attempted to detach unsafe devices.	None
5 SFDR_ERR_UTHREAD	User thread could not be stopped.	Retry the operation. If this error persists, try stopping the process with the <code>kill(1)</code> command.
6 SFDR_ERR_RTTHREAD	Realtime thread could not be stopped.	Retry the operation. If this error persists, try stopping the process with the <code>kill(1)</code> command.
7 SFDR_ERR_KTHREAD	Kernel thread could not be stopped.	Retry the operation. If this error persists, try stopping the process with the <code>kill(1)</code> command.
8 SFDR_ERR_OSFAILURE	The kernel is not processing DR operations properly for the DR driver.	None
9 SFDR_ERR_OUTSTANDING	The <code>ioctl()</code> failed because an error from a previous DR drain operation still has not been reported through the DR status command.	Retry the operation.
11 SFDR_ERR_CONFIG	The current system configuration will not allow the DR operation to execute.	Check the <code>/etc/system</code> file to ensure that memory detach is enabled.
12 SFDR_ERR_NOMEM	Not enough memory	None
13 SFDR_ERR_PROTO	Protocol failure	None

TABLE A-4 PSM Error Messages (Continued)

Error Message	Probable Cause	Suggested Action
14 SFDR_ERR_BUSY	The device is busy.	Check the I/O usage of the device to determine the cause of this error (for example, a mounted file system or the last path to an AP device). If possible, manually adjust the system to correct this error (for instance, unmount the file system). If the cause of the error is not apparent, contact your Sun service provider.
15 SFDR_ERR_NODEV	No devices are present.	None
16 SFDR_ERR_INVALID	Invalid argument and/or operation	None
17 SFDR_ERR_STATE	Invalid board state (transition)	None
18 SFDR_ERR_PROBE	Failed to probe OBP nodes for a board.	None
19 SFDR_ERR_DEPROBE	Failed to deprobe OBP nodes for a board.	None
20 SFDR_ERR_HW_INTERCONNECT	Interconnect hardware failed.	None
21 SFDR_ERR_OFFLINE	Failed to place a CPU offline.	None
22 SFDR_ERR_ONLINE	Failed to bring a CPU online.	None
23 SFDR_ERR_CPUSTART	Failed to start a CPU.	None
24 SFDR_ERR_CPUSTOP	Failed to stop a CPU.	None
25 SFDR_ERR JUGGLE_ BOOTPROC	Failed to move the clock-signal CPU.	None
26 SFDR_ERR_CANCEL	Could not cancel a RELEASE operation.	Retry the Abort Detach operation after the Drain operation is complete.

General Failures

The following table contains a list of the general failure error messages that are sent to the system logs and/or to the SSP applications.

TABLE A-5 General Failure Error Messages

Error Message	Probable Cause	Suggested Action
DR Error: Cannot fork() process . . . <i>errno_description</i>	The DR daemon could not fork off a process for the command to run in. A message in the form “running command” appears in the system logs prior to this error message, or any other error message about failed commands.	The <i>errno_description</i> offers hints on how to fix the command that you want to run. Also check the man page for the command. It may have an explanation of the error.
DR Error: <i>command</i> has continued	While the DR daemon was running external commands, one of the commands failed or exited abnormally. The DR feature executes external commands (for example, <i>drvconf</i>) to configure the software subsystems.	Run the program manually on the domain. If the command fails again, refer to the man page for the command. It may have an explanation of the error.
DR Error: <i>command</i> stopped by signal <i>signal_number</i>	While the DR daemon was running external commands, one of the commands failed or exited abnormally. The DR feature executes external commands (for example, <i>drvconf</i>) to configure the software subsystems.	Run the program manually on the domain. If the command fails again, refer to the man page for the command. It may have an explanation of the error.
DR Error: <i>command</i> terminated due to signal <i>signal_number</i>	While the DR daemon was running external commands, one of the commands failed or exited abnormally. The DR feature executes external commands (for example, <i>drvconf</i>) to configure the software subsystems.	Run the program manually on the domain. If the command fails again, refer to the man page for the command. It may have an explanation of the error.
DR Error: <i>command</i> terminated due to signal <i>signal_number</i> . Core dumped.	While the DR daemon was running external commands, one of the commands failed or exited abnormally. The DR feature executes external commands (for example, <i>drvconf</i>) to configure the software subsystems.	Run the program manually on the domain. If the command fails again, refer to the man page for the command. It may have an explanation of the error.

TABLE A-5 General Failure Error Messages (*Continued*)

Error Message	Probable Cause	Suggested Action
DR Error: dr_issue_ioctl: failed closing driver . . . <i>errno_description</i>	The DR daemon encountered a failure while it tried to close a DR driver entry point. A more detailed explanation of this failure accompanies the error message.	Use the <code>close(2)</code> man page and the <i>errno_description</i> to determine what caused this error and how to solve it.
Cannot exec command (<i>errno</i> = <i>errno_value</i>).	The DR daemon could not execute the external command. A more detailed explanation of this failure accompanies the error message.	Check the system logs to determine which command failed. See the <code>exec(2)</code> man page for more details about the specified <i>errno_value</i> . Use this information to solve the error.
dr_get_sysbrd_info: NULL parameter	An invalid pointer was given to the DR daemon during a query of the slot-to-memory address mapping. Either an RPC gave an incorrect value, or the DR daemon called itself with an invalid parameter.	You should gather as much information about this problem as possible from the system logs so that you can determine the cause of the failure. Try stopping and starting the DR daemon and the SSP application. If this error persists, report it to your Sun service representative.
update_cpu_info: bad board number	A problem within the DR daemon occurred, causing it to call its internal routines with incorrect values.	You should gather as much information about this problem as possible from the system logs so that you can determine the cause of the failure. You should also report this problem, and if it persists, you may have to stop and restart the daemon.
WARNING: Failed to update board <i>board_number</i> 's modification time [non- fatal].	Updating the board modification time has failed. After a board has been modified (for example, memory or CPUs added), it is probed or deprobed by OBP so that OBP can inform other programs of the change. Then, the modification time is updated.	This error is non-fatal.

Protocol and Communication Error Messages

The following table contains the protocol and communication error messages that are sent to the system logs and/or the SSP applications.

TABLE A-6 Protocol and Communication Failure Error Messages

Error Message	Probable Cause	Suggested Action
<p>DR Error: abort_attach_board: invalid board number</p> <p>This error message is sent to the system logs and to the SSP applications.</p>	<p>The RPC is attempting to perform a DR operation on a board number that is not in the range of valid numbers. The DR applications carefully filter the user input to catch out-of-range board numbers before they send the RPC. Therefore, this error indicates a breakdown on the SSP or in the network connection to the SSP. Or, it indicates an incompatibility between the SSP applications and the DR daemon.</p>	<p>Check the SSP network connection and/or the SSP and DR applications to ensure that they are operating properly.</p>
<p>DR Error: abort_detach_board: invalid board number</p> <p>This error message is sent to the system logs and to the SSP applications.</p>	<p>The RPC is attempting to perform a DR operation on a board number that is not in the range of valid numbers. The DR applications carefully filter the user input to catch out-of-range board numbers before they send the RPC. Therefore, this error indicates a breakdown on the SSP or in the network connection to the SSP. Or, it indicates an incompatibility between the SSP applications and the DR daemon.</p>	<p>Check the SSP network connection and/or the SSP and DR applications to ensure that they are operating properly.</p>

TABLE A-6 Protocol and Communication Failure Error Messages (Continued)

Error Message	Probable Cause	Suggested Action
<p>DR Error: attach_finished: invalid board number</p> <p>This error message is sent to the system logs and to the SSP applications.</p>	<p>The RPC is attempting to perform a DR operation on a board number that is not in the range of valid numbers. The DR applications carefully filter the user input to catch out-of-range board numbers before they send the RPC. Therefore, this error indicates a breakdown on the SSP or in the network connection to the SSP. Or, it indicates an incompatibility between the SSP applications and the DR daemon.</p>	<p>Check the SSP network connection and/or the SSP and DR applications to ensure that they are operating properly.</p>
<p>DR Error: complete_attach_board: invalid board number</p> <p>This error message is sent to the system logs and to the SSP applications.</p>	<p>The RPC is attempting to perform a DR operation on a board number that is not in the range of valid numbers. The DR applications carefully filter the user input to catch out-of-range board numbers before they send the RPC. Therefore, this error indicates a breakdown on the SSP or in the network connection to the SSP. Or, it indicates an incompatibility between the SSP applications and the DR daemon.</p>	<p>Check the SSP network connection and/or the SSP and DR applications to ensure that they are operating properly.</p>
<p>DR Error: cpu0_move_finished: invalid board number</p> <p>This error message is sent to the system logs and to the SSP applications.</p>	<p>The RPC is attempting to perform a DR operation on a board number that is not in the range of valid numbers. The DR applications carefully filter the user input to catch out-of-range board numbers before they send the RPC. Therefore, this error indicates a breakdown on the SSP or in the network connection to the SSP. Or, it indicates an incompatibility between the SSP applications and the DR daemon.</p>	<p>Check the SSP network connection and/or the SSP and DR applications to ensure that they are operating properly.</p>

TABLE A-6 Protocol and Communication Failure Error Messages (Continued)

Error Message	Probable Cause	Suggested Action
<p>DR Error: detach_board: invalid board number</p> <p>This error message is sent to the system logs and to the SSP applications.</p>	<p>The RPC is attempting to perform a DR operation on a board number that is not in the range of valid numbers. The DR applications carefully filter the user input to catch out-of-range board numbers before they send the RPC. Therefore, this error indicates a breakdown on the SSP or in the network connection to the SSP. Or, it indicates an incompatibility between the SSP applications and the DR daemon.</p>	<p>Check the SSP network connection and/or the SSP and DR applications to ensure that they are operating properly.</p>
<p>DR Error: detach_finished: invalid board number</p> <p>This error message is sent to the system logs and to the SSP applications.</p>	<p>The RPC is attempting to perform a DR operation on a board number that is not in the range of valid numbers. The DR applications carefully filter the user input to catch out-of-range board numbers before they send the RPC. Therefore, this error indicates a breakdown on the SSP or in the network connection to the SSP. Or, it indicates an incompatibility between the SSP applications and the DR daemon.</p>	<p>Check the SSP network connection and/or the SSP and DR applications to ensure that they are operating properly.</p>
<p>DR Error: detachable_board: invalid board number</p> <p>This error message is sent to the system logs and to the SSP applications.</p>	<p>The RPC is attempting to perform a DR operation on a board number that is not in the range of valid numbers. The DR applications carefully filter the user input to catch out-of-range board numbers before they send the RPC. Therefore, this error indicates a breakdown on the SSP or in the network connection to the SSP. Or, it indicates an incompatibility between the SSP applications and the DR daemon.</p>	<p>Check the SSP network connection and/or the SSP and DR applications to ensure that they are operating properly.</p>

TABLE A-6 Protocol and Communication Failure Error Messages (Continued)

Error Message	Probable Cause	Suggested Action
<p>DR Error: <code>drain_board_resources:</code> <code>invalid board number</code></p>	<p>The RPC is attempting to perform a DR operation on a board number that is not in the range of valid numbers. The DR applications carefully filter the user input to catch out-of-range board numbers before they send the RPC. Therefore, this error indicates a breakdown on the SSP or in the network connection to the SSP. Or, it indicates an incompatibility between the SSP applications and the DR daemon.</p>	<p>Check the SSP network connection and/or the SSP and DR applications to ensure that they are operating properly.</p>
<p>This error message is sent to the system logs and to the SSP applications.</p>		
<p>DR Error: <code>get_board_config:</code> <code>invalid board number</code></p>	<p>The RPC is attempting to perform a DR operation on a board number that is not in the range of valid numbers. The DR applications carefully filter the user input of catch out-of-range board numbers before they send the RPC. Therefore, this error indicates a breakdown on the SSP or in the network connection to the SSP. Or, it indicates an incompatibility between the SSP applications and the DR daemon.</p>	<p>Check the SSP network connection and/or the SSP and DR applications to ensure that they are operating properly.</p>
<p>This error message is sent to the system logs and to the SSP applications.</p>		
<p>DR Error: <code>get_board_state:</code> <code>invalid board number</code></p>	<p>The RPC is attempting to perform a DR operation on a board number that is not in the range of valid numbers. The DR applications carefully filter the user input to catch out-of-range board numbers before they send the RPC. Therefore, this error indicates a breakdown on the SSP or in the network connection to the SSP. Or, it indicates an incompatibility between the SSP applications and the DR daemon.</p>	<p>Check the SSP network connection and/or the SSP and DR applications to ensure that they are operating properly.</p>
<p>This error message is sent to the system logs and to the SSP applications.</p>		

TABLE A-6 Protocol and Communication Failure Error Messages (Continued)

Error Message	Probable Cause	Suggested Action
<p>DR Error: <code>get_cpu_info:</code> <code>invalid board number</code></p> <p>This error message is sent to the system logs and to the SSP applications.</p>	<p>The RPC is attempting to perform a DR operation on a board number that is not in the range of valid numbers. The DR applications carefully filter the user input to catch out-of-range board numbers before they send the RPC. Therefore, this error indicates a breakdown on the SSP or in the network connection to the SSP. Or, it indicates an incompatibility between the SSP applications and the DR daemon.</p>	<p>Check the SSP network connection and/or the SSP and DR applications to ensure that they are operating properly.</p>
<p>DR Error: <code>get_obp_board_config:</code> <code>invalid board number</code></p> <p>This error message is sent to the system logs and to the SSP applications.</p>	<p>The RPC is attempting to perform a DR operation on a board number that is not in the range of valid numbers. The DR applications carefully filter the user input to catch out-of-range board numbers before they send the RPC. Therefore, this error indicates a breakdown on the SSP or in the network connection to the SSP. Or, it indicates an incompatibility between the SSP applications and the DR daemon.</p>	<p>Check the SSP network connection and/or the SSP and DR applications to ensure that they are operating properly.</p>
<p>DR Error: <code>initiate_attach_board:</code> <code>invalid board number</code></p> <p>This error message is sent to the system logs and to the SSP applications.</p>	<p>The RPC is attempting to perform a DR operation on a board number that is not in the range of valid numbers. The DR applications carefully filter the user input to catch out-of-range board numbers before they send the RPC. Therefore, this error indicates a breakdown on the SSP or in the network connection to the SSP. Or, it indicates an incompatibility between the SSP applications and the DR daemon.</p>	<p>Check the SSP network connection and/or the SSP and DR applications to ensure that they are operating properly.</p>

TABLE A-6 Protocol and Communication Failure Error Messages (*Continued*)

Error Message	Probable Cause	Suggested Action
DR Error: initiate_attach_board: invalid cpu number This error message is sent to the system logs and to the SSP applications.	The RPC is attempting to perform a initiate an attach of a board that contains a CPU that is not on the board. The DR applications carefully filter the user input or catch invalid CPU numbers before they send the RPC. Therefore, this error indicates a breakdown on the SSP or in the network connection to the SSP. Or, it indicates an incompatibility between the SSP applications and the DR daemon.	Check the SSP network connection and/or the SSP and DR applications to ensure that they are operating properly.
DR Error: Unauthorized RPC call . . . Not owner This error message is sent to the system logs and to the SSP applications.	The DR daemon received an RPC that failed authentication.	Check the system log for more information about this error. Also, make sure that the version numbers match for the SSP and the DR daemon and that the SSP user and network services are properly configured.

Attach-Related Failures

The following table contains attach-related failure errors that are sent to the system logs and/or the SSP applications.

TABLE A-7 Attach-Related Failure Error Messages

Error Message	Probable Cause	Suggested Action
DR Error: abort_attach_board: invalid board state	The Attach operation could not be aborted because the board is not in the Init-Attach state, awaiting to be configured into the domain.	Wait for the board to enter the Init-Attach state. Only then can the Attach operation be aborted.
DR Error: attach_finished: invalid board state	Communication protocol has been breached over the state of the attach operation. The DR driver and daemon disagree with the SSP that the board was waiting for the confirmation of the Attach operation from the SSP.	Exit and restart the current DR application, then retry the operation. If this error persists, stop and restart the DR daemon. You may need to reboot the domain to recover from this error.

TABLE A-7 Attach-Related Failure Error Messages (Continued)

Error Message	Probable Cause	Suggested Action
DR Error: Cannot abort attach. Board ineligible for further DR operations.	The board entered the FATAL state after the abort command was issued, causing the abort operation to fail and the board to be lost from the system.	Reboot the domain.
dr_attach: failure executing A3000 hot_add script . . . <i>error message</i>	The Sun™ StoreEdge™ A3000 hot_add script is executed directly after a DR Attach operation. If the script exists, but it cannot be executed, the error message explains why.	If you are not using, nor plan to use, A3000 devices, you can rename the script so that it will not be found.
initiate_attach_board: already init-attached	You attempted to initiate the attach of a board that was already initiated.	Go to the Complete Attach window and continue the attach process.
DR Error: complete_attach_board: invalid board state	You tried to initiate an Attach operation on a board that is not eligible—the board is not in the Init-Attach state awaiting attachment to the domain.	Wait for the board to enter the Init-Attach state. Only then can the Attach operation be aborted.
DR Error: initiate_attach_board: invalid board state	You tried to initiate an Attach operation on a board that is not eligible—the board is not in the PRESENT state awaiting attachment to the domain.	Wait for the board to enter the Init-Attach state. Only then can the Attach operation be aborted.
DR Error: Some devices not attached. Examine the host syslog for details . . . <i>errno_description</i>	Some of the devices were not configured into the domain.	Look at the system logs for more details about what devices were not configured into the domain and why they were not configured. Some devices on the board may not be supported by the operating environment or by the DR feature. You should blacklist unsupported devices.

Detach-Related Error Messages

The following table contains detach-related error messages that are sent to the system logs and/or to the SSP applications.

TABLE A-8 Detach-Related Failure Error Messages

Error Message	Probable Cause	Suggested Action
DR Error: Cannot detach board <code>board_number</code> . It has <code>interface_name</code> interfaces configured.	The board is not eligible to be detached because it has one or more network interfaces attached to it that are critical to the operation of the domain. The network interfaces can be any mix of primary, SSP, AP, or PBF interfaces.	Use the <code>ifconfig(1M)</code> command to determine the role of the interface(s). If the configured interface is the primary network or the SSP, manually switch the interface to the alternate interface if one exists. For an interface other than the primary and the SSP, unplumbing it may enable the Detach operation to succeed. Otherwise, the domain must be shut down, and the interfaces must be moved to another board.
DR Error: <code>cpu0_move_finished: invalid board state</code>	Communication protocol has been breached over the eligibility of a CPU. To the SSP, the CPU has been moved off of the board. To the DR driver, the move operation is an invalid operation for that board.	None
<code>ifconfig down failed.</code>	The <code>ifconfig(1M)</code> command failed to bring down the network interfaces. The <code>ifconfig(1M)</code> command unplumbs and brings down the network interfaces before the board is detached. One of the network interfaces on the board could be busy, so manual intervention may be needed.	Log in to the domain, and, if possible, bring down the network interfaces on the board manually by using the <code>ifconfig(1M)</code> command with the <code>down</code> option. The manual execution of the command may yield more detailed information about the failure.

TABLE A-8 Detach-Related Failure Error Messages (Continued)

Error Message	Probable Cause	Suggested Action
<code>ifconfig unplumb failed.</code>	The <code>ifconfig(1M)</code> command failed to unplumb the network interfaces. The <code>ifconfig(1M)</code> command unplumbs and brings down the network interfaces before the board is detached. One of the network interfaces on the board could be busy, so manual intervention may be needed.	Log in to the domain, and, if possible, unplumb the network interfaces manually by using the <code>ifconfig(1M)</code> command with the <code>unplumb</code> option. The manual execution of the command may yield more detailed information about the failure.
Warning: Error return from <code>/opt/SUNWconn/bin/nf_snmd_kill (return_value)</code>	The command failed. Certain daemons keep network interfaces open continuously. Those daemons must be stopped before the devices they control can be detached.	Analyze the <code>return_value</code> to determine why the <code>kill(1)</code> command failed, and try to correct the problem. If necessary, use the <code>ps(1)</code> command to obtain the PID number for the daemons, and use the <code>kill(1)</code> command to stop the daemons manually.
Warning: Error return from <code>/opt/SUNWconn/bin/pf_snmd_kill (return_value)</code>	The <code>kill(1)</code> command failed. The daemons that are used to control certain network devices must be stopped before the devices can be detached because the daemons keep the interfaces open continually.	Analyze the <code>return_value</code> to determine why the <code>kill</code> command failed, and try to correct the problem. If necessary, use the <code>ps(1)</code> command to obtain the PID number for the daemons, and use the <code>kill(1)</code> command to stop the daemons manually.
DR Error: <code>abort_detach: board already drained</code>	The <code>CANCEL ioctl()</code> failed while the DR daemon was trying to abort the Detach operation. The failure caused the board to be reported as being in the <code>UNREFERENCED</code> state, indicating that the memory has already been drained.	The board must be completely detached before you can recover from this error. Retry the DR operation after the board has been successfully detached.
DR Error: <code>abort_detach_board: invalid board state</code>	Communication protocol has been breached over the eligibility of a board. To the SSP, the board is part of the domain and has been, or is being, drained of its resources. The SSP, therefore, issues the <code>abort</code> command to stop the Detach operation. However, to the DR driver and daemon, the board is not part of the domain.	Exit and restart the DR application.

TABLE A-8 Detach-Related Failure Error Messages (Continued)

Error Message	Probable Cause	Suggested Action
DR Error: board configuration query failed.	The DR daemon failed to ascertain the eligibility of the configuration of the board.	Stop and start the DR daemon and/or the DR driver. If this error persists, use the <code>modinfo(?)</code> , <code>modload(1M)</code> , and <code>modunload(1M)</code> commands to work with the driver after you have stopped the DR daemon. Also, check the size of the DR daemon with the <code>ps(1)</code> command. If it is not between 300- and 400 Kbytes, report this error, providing as much information from the system logs as possible.
DR Error: Cannot abort detach. Board detached from OS (detach completed).	This message indicates that the Detach operation has completed. It follows the message that is displayed for the DR Error: <code>abort_detach: board already drained</code> error message.	See the DR Error: <code>abort_detach: board already drained</code> message.
DR Error: couldn't query cpu configuration	The Complete-Detach operation has failed because the DR daemon could not ascertain the CPU configuration just prior to the beginning of the Complete-Detach operation. After a board is detached, the DR daemon uses the information about the CPU configuration to update the <code>utmp</code> and <code>wtmp</code> entries for each CPU on the board. Although the Complete-Attach operation does not depend on the updates, if the mechanisms through which the CPU configuration is queried are broken, serious problems exist, so a completion of the Detach operation should not proceed.	Stop and start the DR daemon and/or the DR driver. Also, check the size of the DR daemon with the <code>ps(1)</code> command. If it is not between 300- and 400-Kbytes, report this error, providing as much information from the system logs as possible.
DR Error: detach_board: invalid board state	Communication protocol has been breached over the eligibility of a board. To the SSP, the board is part of the domain, and its resources have been drained, causing the SSP to attempt to complete the detach operation. However, to the DR driver and daemon, the board is not part of the domain.	Examine the state of the board by using the <code>dr_cmd_board_states(?)</code> command, and determine the cause of the problem. Retry the Drain and/or Complete-Detach operations to determine if the error is recoverable. Stop and start the DR daemon and driver.

TABLE A-8 Detach-Related Failure Error Messages (*Continued*)

Error Message	Probable Cause	Suggested Action
DR Error: detach_board: invalid board state	The proper sequence of board states has not been followed, meaning that the board went into the error state or that an earlier failure in the drain-detach sequence of events was not properly reported.	Examine the state of the board by using the <code>dr_cmd_board_states(?)</code> command, and determine the cause of the problem. Retry the Drain and/or Complete-Detach operations to determine if the error is recoverable. Stop and start the DR daemon and driver.
DR Error: detach_finished: invalid board state	Communication protocol has been breached over the eligibility of a board. To the SSP, the board has been detached. However, to the DR driver and daemon, the board has not been detached from the domain.	Examine the state of the board by using the <code>dr_cmd_board_states(?)</code> command, and determine the cause of the problem. Retry the Drain and/or Complete-Detach operations to determine if the error is recoverable. Stop and start the DR daemon and driver.
DR Error: detachable_board: invalid board state	Communication protocol has been breached over the eligibility of a board. To the SSP, the board is part of the domain, so the SSP attempts to drain the resources. However, to the DR driver and daemon, the board is not part of the domain.	Examine the state of the board by using the <code>dr_cmd_board_states(?)</code> command, and determine the cause of the problem. Retry the Drain and/or Complete-Detach operations to determine if the error is recoverable. Stop and start the DR daemon and driver.
DR Error: detaching board would leave no online CPUs	The Detach operation failed because no CPUs would be left online after the board is detached.	Bring more CPUs online on other boards in the domain, or add more boards with online CPUs to the domain, so that the domain will have enough online CPUs after the board is detached.

TABLE A-8 Detach-Related Failure Error Messages (*Continued*)

Error Message	Probable Cause	Suggested Action
<p>DR Error: <code>drain_board_resources:</code> invalid board state</p>	<p>Communication protocol has been breached over the eligibility of a board. To the SSP, the board is part of the domain, so the SSP attempts to drain the resources. However, to the DR driver and daemon, the board is not part of the domain.</p>	<p>Examine the state of the board by using the <code>dr_cmd_board_states(?)</code> command, and determine the cause of the problem. Retry the Drain and/or Complete-Detach operations to determine if the error is recoverable. Stop and start the DR daemon and driver.</p>
<p>DR Error: Remaining system memory (<i>memory_size</i> mb) below minimum threshold (<i>minimum_memory_size</i> mb)Not enough space</p>	<p>The domain must have enough memory to accommodate the memory of the board that is being detached. The detach operation failed because the domain does not have enough memory to detach the board.</p>	<p>Attach as many boards as necessary so that the memory in the domain will hold the memory on the board being detached.</p>
<p>DR Error: Some devices not re-attached. Examine the host syslog for details <i>errno_description</i></p>	<p>Devices could not be reattached to the operating environment during an Abort Detach operation. Errors were encountered while the DR daemon tried to communicate with the device drivers for one or more devices on the board.</p>	<p>Examine the system logs to determine which devices were not reattached. If possible, fix the problem then issue the <code>complete_attach(1M)</code> command again to fully configure the board. If this action fails, the failure may be caused by an unsupported device for which a state cannot be resolved until the domain is rebooted.</p>
<p>DR Error: <code>sysconf</code> failed (<code>_SC_NPROCESSORS_ONLN</code>) <i>errno_description</i></p>	<p>The <code>sysconf(3c)</code> system call failed to return the total number of online CPUs in the domain. Thus, the DR daemon cannot determine if the domain would be left with any online CPUs after the board is detached.</p>	<p>See the <code>sysconf(3c)</code> man page for more details about this error. Use those details and the <i>errno_description</i> to diagnose and solve the error. Retry the DR operation after you have solved the error. If no fix is apparent, stop and restart the DR daemon, then retry the DR operation.</p>

Auto-Configuration Error Messages

The following table contains the list of auto-configuration error messages that are sent to the system logs and/or to the SSP applications.

TABLE A-9 Auto-Configuration Error Messages

Error Message	Probable Cause	Suggested Action
DR Error: Complete pending DR operation prior to running autoconfig . . . Invalid argument	The autoconfig(1M) command failed because a DR operation was still pending (that is, the board was not fully detached or attached before you issued the autoconfig(1M) command to reconfigure the operating environment).	Use the <code>dr_cmd_board_states(1M)</code> command to determine the state of the board. Decide to abort or complete the pending operation before you try to use the <code>autoconfig(1M)</code> command to reconfigure the operating environment.
DR Error: Could not get / tmp/AdDrEm.lck lock . . . <i>errno_description</i>	The DR daemon failed to get the lock it needs so that it can reconfigure the operating environment.	Check the additional <i>errno_description</i> and/or error number that is sent with the error message to determine why the lock could not be acquired.
DR Error: Could not unlock /tmp/AdDrEm.lck lock . . . <i>errno_description</i>	The DR daemon could not release the lock.	Check the additional <i>errno_description</i> and/or error number that is sent with the error message to determine why the lock was not released.
DR Error: devlinks cmd failed. . . <i>error descriptions</i>	The devlinks(1M) command failed to reconfigure the operating environment.	Check the additional <i>error descriptions</i> and/or error number that is sent with the error message to determine why the command failed. Manually run the command on the domain.
DR Error: disks cmd failed . . . <i>error descriptions</i>	The disks(1M) command failed to reconfigure the operating environment.	Check the additional <i>error descriptions</i> and/or error number that is sent with the error message to determine why the command failed. Manually run the command on the domain.

TABLE A-9 Auto-Configuration Error Messages (*Continued*)

Error Message	Probable Cause	Suggested Action
DR Error: drvconfig cmd failed. . . <i>error description</i>	The drvconfig(1M) command failed to reconfigure the operating environment.	Check the additional <i>error description</i> and/or error number that is sent with the error message to determine why the command failed. Manually run the command on the domain.
DR Error: ports cmd failed . . . <i>error description</i>	The ports(1M) command failed to reconfigure the operating environment.	Check the additional <i>error description</i> and/or error number that is sent with the error message to determine why the command failed. Manually run the command on the domain.
DR Error: sync cmd failed . . . <i>error description</i>	The sync(1M) command failed to reconfigure the operating environment.	Check the additional <i>error description</i> and/or error number that is sent with the error message to determine why the command failed. Manually run the command on the domain.
DR Error: tapes cmd failed . . . <i>error descriptions</i>	The tapes(1M) command failed to reconfigure the operating environment.	Check the additional <i>error description</i> and/or error number that is sent with the error message to determine why the command failed. Manually run the command on the domain.

System Exploration Error Messages

The following table contains the system exploration error messages that are sent to the system logs and/or to the SSP applications.

TABLE A-10 System Exploration Error Messages

Error Message	Probable Cause	Suggested Action
Cannot open /etc/ driver_aliases; dr_daemon may not operate correctly without driver alias mappings . . . <i>errno_description</i>	The DR daemon made an incorrect decision about the detachability and usage of devices in the domain. It is a non-fatal error.	Analyze what caused this error by using the <i>errno_description</i> , and try to correct the error. Look for incorrect file permissions or some kind of resource limit that has been encountered. After you correct the error, you must stop the DR daemon, then restart it so that it attempts to read the driver alias mappings again.
Cannot open mnttab (<i>errno=errno_value</i>)	The DR daemon does not allow a detachability test to pass if the <i>mnttab</i> file cannot be opened and examined to determine which file systems are mounted. If the test is not stopped, a mounted file system could be detached from the domain.	Analyze the cause of this error by using the <i>errno_value</i> , and try to correct the error. The DR daemon may have encountered a resource limit. If so, stop the daemon then restart it. Also, check the size of the DR daemon. It should be between 300- and 400-Kbytes. If it is not within this range, stop the daemon then restart it.

TABLE A-10 System Exploration Error Messages (Continued)

Error Message	Probable Cause	Suggested Action
<p>Cannot open socket (<i>errno=errno_value</i>)</p> <p>This error message is sent only to the system logs.</p>	<p>The DR daemon could not open a network device. All network devices are opened to test their usage.</p>	<p>Determine what caused this error by using the <i>errno_value</i>. The DR daemon may have encountered a resource limit. If so, stop the daemon then restart it. Also, check the size of the DR daemon. It should be between 300- and 400-Kbytes. If it is not within this range, stop the daemon then restart it. If you cannot recover the domain from this error or if symptoms of a memory leak exist, report this error to your Sun service representative, providing as much information from the system logs as possible.</p>
<p><code>get_cpu_bindings: can't access /proc filesystem [non-fatal].</code></p>	<p>The /proc filesystem cannot be opened. When the DR daemon explores the domain to determine the CPU information for a board, the /proc filesystem is examined to determine which PIDs, if any, are bound to the CPUs on the board. Bound processes negatively affect the detachability of a board. A complete detach operation will fail if processes are bound to a CPU.</p>	<p>Check to see why the /proc filesystem cannot be accessed. In the domain, process binding and processor set management programs, or processor management programs, can be used to manually determine the CPU information for a board.</p>
<p><code>get_mem_config: couldn't determine total system memory size; only 1 board counted [non-fatal].</code></p>	<p>When the DR daemon tried to count the amount of total memory, it could report only the amount of memory on the selected board, meaning that the system memory field reported by the <code>drshow board_number mem</code> command is inaccurate. The inaccuracy also negatively affects the eligibility of a board for a Detach operation because if the total memory cannot be calculated, then the effects of removing a board from the domain cannot be calculated as well.</p>	<p>Stop and restart the DR daemon and driver. Report this error, providing as much information from the system logs as possible. A memory leak could also have occurred over time. Check the size of the DR daemon by using the <code>ps(1)</code> command. The size should be between 300- and 400-Kbytes. If the size is not within this range, stop and start the DR daemon and driver.</p>

TABLE A-10 System Exploration Error Messages (Continued)

Error Message	Probable Cause	Suggested Action
get_net_config_info: interface_name no address (errno=errno_value)	The DR daemon encountered a failure while it tried to obtain information about a network interface that was configured by using the ifconfig(1M) command.	Determine what caused this error by using the <i>errno_value</i> , then correct the error.
getmntent returned error	The getmntent(3c) system call failed because the mount-point entries could not be properly examined. If the mount-point entries cannot be properly examined, a mounted file system could be detached from the domain.	Analyze the <i>mnttab</i> file for possible corruption. If any exists, correct it. Also, the DR daemon may have encountered a resource limit. If so, stop the daemon then restart it. Finally, check the size of the DR daemon. It should be between 300- and 400-Kbytes. If it is not within this range, stop the daemon then restart it. If you cannot recover the domain from this error or symptoms of a memory leak exist, report this error to your Sun service representative, providing as much information from the system logs as possible.
Host addr for <i>interface_name</i> not found (h_errno=errno_value)	The file that is needed to test each active network device may not exist, or it may be corrupted. While the network devices are examined, each active network device is tested to determine if it is the primary network interface for the domain. The DR daemon will not allow the detachability test to pass if it cannot determine which active network device is the primary network interface for the domain.	Use the <i>errno_value</i> to determine if the file exists or if it is corrupted, and correct the error as necessary. The file is named <i>/etc/hostname.interface_name</i> , where <i>interface_name</i> is the interface named in the error message.
Host address field for <i>interface_name</i> is null!!	The IP address for the primary interface (<i>interface_name</i>) is not set properly. While the network devices are examined, each active network device is tested to determine if it is the primary network interface for the domain. The DR daemon will not allow the detachability test to pass if it cannot determine which active network device is the primary network interface for the domain.	Reconfigure the network setup for the domain. You may need to reboot the domain to configure network devices.

TABLE A-10 System Exploration Error Messages (Continued)

Error Message	Probable Cause	Suggested Action
Host address for <i>interface_name</i> must be internet address.	The file that is needed to test each active network device may have a corrupted value or an incorrect network address. While the network devices are examined, each active network device is tested to determine if it is the primary network interface for the domain. The DR daemon will not allow the detachability test to pass if it cannot determine which active network device is the primary network interface for the domain.	Make sure that the hostname file for the primary network interface contains an IP address in the proper form (that is, <i>xxx.xxx.xxx.xxx</i>). The file is named <i>/etc/hostname.interface_name</i> , where <i>interface_name</i> is the interface named in the error message.
I/O bus device tree not built.	This error message continues added information about the DR Error: device tree not built error message, in which the libdevinfo API failed to build the device tree for the system board.	See the DR Error: device tree not built error message.
minor_walk: failed to build net leaf.	This error message continues added information about the DR Error: device tree not built error message, in which the libdevinfo API failed to build the device tree for the system board. This message indicates that the libdevinfo API at least started to look at the minor devices for a network leaf node.	See the DR Error: device tree not built error message.
minor_walk: failed to build non-net leaf.	This error message continues added information about the device tree not built error message, indicating that the libdevinfo API at least started to look at the minor devices for a non-network leaf node.	See the DR Error: I/O bus device tree not built error message.
Partition <i>partition_name</i> does not have parent.	The device tree is in error because it includes a disk partition that does not have a parent device, such as the disk to which the partition belongs.	A device could be bad, or a reboot may be necessary. If this error continues to appear, report the error to your Sun service representative, providing as much information from the system logs as possible.

TABLE A-10 System Exploration Error Messages (Continued)

Error Message	Probable Cause	Suggested Action
Recursive symlink found ' <i>symbolic_link_name</i> '. Please remove it.	The DR daemon found a symbolic link as it walked the /dev and /devices directories. Some symbolic links create a recursive loop. The DR daemon will not allow the detachability test to pass if it finds a symbolic link in one of these directories.	Remove the symbolic link so that the test can be retried.
swapctl SC_GETNSWP failed (errno= <i>errno_value</i>)	The swapctl(2) system call failed. This system call is used to determine which disk partitions are in use as swap space. The DR daemon will not allow the detachability test to pass if the use of swap partitions cannot be determined.	Analyze what caused this error by using the <i>errno_value</i> , and try to correct it. Use the swapctl(2) man page and the <i>errno_value</i> to determine why the command failed. The DR daemon may have encountered a resource limit. If so, stop the daemon then restart it. Also, check the size of the DR daemon. it should be between 300- and 400-Kbytes. If it is not within this range, stop the daemon then restart it. If you cannot recover the domain from this error or if symptoms of a memory leak exist, report this error to your Sun service representative, providing as much information from the system logs as possible.
Unable to find cwd <i>errno_value</i>	The DR daemon could not save the current working directory. The daemon switches into the /dev and /devices directories to produce the <i>real</i> pathnames that correspond to device drivers.	Determine what caused this error by using the getcmd(3c) man page and the <i>errno_value</i> , then correct the error.
Unable to find the cwd <i>errno_value</i>	The DR daemon could not determine the name of the driver directory. The daemon switches into the /dev and /devices directories to produce the <i>real</i> pathnames that correspond to device drivers.	Determine what caused this error by using the getcmd(3c) man page and the <i>errno_value</i> , then correct the error.

TABLE A-10 System Exploration Error Messages (*Continued*)

Error Message	Probable Cause	Suggested Action
Unable to get swap entries (<i>errno=errno_value</i>)	The <code>swapctl(2)</code> system call failed. This system call is used to determine which disk partitions are in use as swap space. The DR daemon will not allow the detachability test to pass if swap partitions cannot be determined.	Analyze what caused this error by using the <code>swapctl(2)</code> man page and the <i>errno_value</i> , and try to correct it. The DR daemon may have encountered a resource limit. If so, stop the daemon then restart it. Also, check the size of the DR daemon. It should be between 300- and 400-Kbytes. If it is not within this range, stop the daemon then restart it. If you cannot recover from this error or if symptoms of a memory leak exist, report this error to your Sun service representative, providing as much information from the system logs as possible.
Unable to <code>lstat devlink_file</code> <i>errno_value</i>	The <code>lstat(2)</code> system call failed when it encountered the <i>devlink_file</i> , where <i>devlink</i> is the name of the symbolic link in the <code>/dev</code> directory.	Determine what caused this error by using the <code>lstat(2)</code> man page and the <i>errno_value</i> . The DR daemon may have encountered a resource limit. If so, stop the daemon then restart it. Also, check the size of the DR daemon. It should be between 300- and 400-Kbytes. If it is not within this range, stop the daemon then restart it. If you cannot recover the domain from this error or if symptoms of a memory leak exist, report this error to your Sun service representative, providing as much information from the system logs as possible.

TABLE A-10 System Exploration Error Messages (Continued)

Error Message	Probable Cause	Suggested Action
Unable to open <i>hostname_file</i> (<i>errno=errno_value</i>)	The information that is needed to test each active network device could not be acquired. While the network devices are examined, each active network device is tested to determine if it is the primary network interface for the domain. The DR daemon will not allow the detachability test to pass if it cannot determine which active network device is the primary network interface for the domain.	Analyze what caused this error by using the <code>open(2)</code> man page and the <i>errno_value</i> , and try to correct it. Look for incorrect file permissions or non-existent files. The <i>hostname_file</i> value consists of a file named <code>/etc/hostname.<i>ifname</i></code> , where <i>ifname</i> is a device name, such as <code>hme0</code> or <code>le0</code> .
Unable to read host name from <i>hostname_file</i>	The file that is needed to test each active network device could not be read. While the network devices are examined, each active network device is tested to determine if it is the primary network interface for the domain. The DR daemon will not allow the detachability test to pass if it cannot determine which active network device is the primary network interface for the domain.	Ensure that the file has the correct permissions and that it has not been corrupted.
Unable to readlink <i>devlink_file</i> <i>errno_value</i>	The <code>readlink(2)</code> system call failed when it encountered the <i>devlink_file</i> , where <i>devlink</i> is the name of the symbolic link in the <code>/dev</code> directory.	Determine what caused this error by using the <code>readlink(2)</code> man page and the <i>errno_value</i> . The DR daemon may have encountered a resource limit. If so, stop the daemon, then restart it. Also, check the size of the DR daemon. It should be between 300- and 400-Kbytes. If it is not within this range, stop the daemon, then restart it. If you cannot recover the domain from this error or if symptoms of a memory leak exist, report this error to your Sun service representative, providing as much information from the system logs as possible.

TABLE A-10 System Exploration Error Messages (Continued)

Error Message	Probable Cause	Suggested Action
Unable to restore cwd <i>errno_value</i>	The DR daemon was unable to change back to the original directory after it changed into /dev or /devices directory. The DR daemon changes into the /dev and /devices directories to explore the relationships of the device driver with other drivers.	This error should not pose a problem for the domain, but you should determine what caused the error by using the <i>errno_value</i> .
Unable to set cwd <i>errno_value</i>	The DR daemon could not change into the /dev and /devices directories. The daemon switches into these directories to produce the <i>real</i> pathnames that correspond to device drivers.	Determine what caused this error by using the <code>chdir(2)</code> man page and the <i>errno_value</i> , then correct the error.
unknown node type	The device tree was built incorrectly. Several functions create the device tree for a system board by using the <code>libdevinfo</code> API, and searches the /dev and /devices directories. After the tree is constructed, it is passed on to the <code>rpc_info()</code> function, which builds the tree, performs some verifications, then translates the tree into a structure that can be returned from an RPC.	Check the size of the DR daemon. It should be between 300- and 400-Kbytes. If it is not within this range, stop the daemon, then restart it. If you cannot recover the domain from this error, report this error to your Sun service representative, providing as much information from the system logs as possible.
utssys failed (<i>errno_value</i>) for <i>mount_point</i>	The <code>utssys()</code> system call failed. This system call is used to determine the usage count for a mounted partition. The DR daemon will not allow the detachability test to pass if the usage count cannot be determined.	Analyze what caused this error by using the <i>errno_value</i> , and try to correct it. The DR daemon may have encountered a resource limit. If so, stop the daemon then restart it. Also, check the size of the DR daemon. It should be between 300- and 400-Kbytes. If it is not within this range, stop the daemon then restart it. If you cannot recover the domain from this error or if symptoms of a memory leak exist, report this error to your Sun service representative, providing as much information from the system logs as possible.

TABLE A-10 System Exploration Error Messages (Continued)

Error Message	Probable Cause	Suggested Action
walk_dir: dirlist buffer overflow.	As it walked the /dev and /devices directories, the DR daemon encountered too many directories, causing a buffer overflow. If this message occurs, detection of or protection against recursive symbolic links is disabled.	Check the /dev and /devices directories for recursive symbolic links. Remove any recursive symbolic links that you find.
walk_dir: tpath buffer overflow. target_path, device_name	The DR daemon cannot add another directory to the target_path. The daemon walks the /dev and /devices directories to discover device name links so that it can add them to the target path. If the daemon encounters this limit, it cannot explore any more directories because the buffer is full. If the daemon stops its search, some of the devices will not appear in the views (DR daemon and SSP) of the domain device tree. You may also see improper autoswitching of AP devices if this error occurs.	Devices that are not added to the target path must be manually unconfigured and switched to other boards in the domain. You may also need to stop any daemon that is keeping a device open.
WARNING: cannot check for cvc/ssp interface.	The information that is needed to test each active network device could not be acquired. While the network devices are examined, each active network device is tested to determine if it corresponds to the SSP network interface for the domain. The DR daemon will not allow the detachability test to pass if it cannot determine the SSP network interface. If the network loses the SSP network interface during a detach operation, DR operations are disabled in the domain, and netcon(1M) sessions are disabled.	Switch the suspected interface to a redundant network connection on another board. You may have to reboot the domain to recover from this error.

TABLE A-10 System Exploration Error Messages (Continued)

Error Message	Probable Cause	Suggested Action
WARNING: Cannot check for primary interface	The information that is needed to test each active network device could not be acquired. While the network devices are examined, each active network device is tested to determine if it is the primary network interface for the domain. The DR daemon will not allow the detachability test to pass if it cannot determine which active network device is the primary network interface for the domain.	Determine which board hosts the primary network interface and re-attach the board to the domain. Or, switch the interface to a redundant network connection on another board in the domain. You may have to reboot the domain to recover from this error.
WARNING: Cannot determine if <i>interface_name_instance</i> is cvc/ssp interface. SIOCGIFNETMASK errno= <i>errno_value</i>	The DR daemon failed to obtain the necessary information to test an active network interface to determine if it is the SSP connection. While the network devices are examined, each active network device is tested to determine if it is the SSP connection for the domain. The DR daemon will not allow the detachability test to pass if it cannot determine which active network device is the SSP connection for the domain. If the network loses the SSP connection during a DR Detach operation, DR operations and netcon(1M) sessions are disabled.	Switch the network interface (<i>interface_name</i>) to another board. If you cannot correct this error, you may have to reboot the domain.
WARNING: cannot stat <i>device_name</i> errno= <i>errno_value</i>	The stat(2) system call cannot access the /dev entry point for a device in the system device tree.	Use the stat(2) man page and the <i>errno_value</i> why the file <i>device_name</i> could not be accessed.
DR Error: Bad page size from sysconf . . . <i>errno_description</i>	The sysconf(3c) system call returned an incorrect value for the system page size, meaning that the system call is broken or that it is not providing a required feature. This error may also explain why queries for memory information or detachability tests are failing due to incorrect reporting of memory sizes.	Use the sysconf(3c) man page and the <i>errno_value</i> to determine the cause of the error.

TABLE A-10 System Exploration Error Messages (Continued)

Error Message	Probable Cause	Suggested Action
DR Error: device tree not built.	The libdevinfo API failed to build the device tree for the system board. More detailed information about this error accompanies the error message.	Make sure that the correct version of the libdevinfo is included on the domain and that a version mismatch does not exist between the DR daemon's libraries, the operating environment on the domain, or the DR daemon itself. If no cause can be found, report this error to your Sun service representative.
DR Error: dr_get_partn_cpus: cannot get cpu's partition . . . <i>errno_description</i>	The DR daemon tried to use the pset_assign(2) function, but the function failed. The DR daemon uses this function to obtain the processor set and partitioning information, which it sends to the CPU Configuration window.	Use the pset_assign(2) man page and the <i>errno_description</i> to determine and correct the cause of this error.
DR Error: dr_get_partn_cpus: failed to get cpu partition info . . . <i>errno_description</i>	The DR daemon tried to use the pset_info(2) function, but the function failed. The DR daemon uses this function to obtain the processor set and partitioning information, which it sends to the CPU Configuration window.	Use the pset_info(2) man page and the <i>errno_description</i> to determine and correct the cause of this error.
DR Error: dr_page_to_kb: page size smaller than a KB	A math error occurred, or an incorrect memory value was used in a memory calculation.	Report this error to your Sun service representative.
DR Error: get_board_config: invalid board state	A communication protocol has been breached over the eligibility of a board. To the SSP, the board is part of the domain. However, to the DR daemon and driver, the board is not part of the domain.	Stop and start the DR application, then retry the operation. If the error persists, use the kill(1M) command to stop the DR daemon, then start the DR daemon and retry the DR operation.

TABLE A-10 System Exploration Error Messages (Continued)

Error Message	Probable Cause	Suggested Action
DR Error: get_board_config: invalid flag	The SSP passed an invalid or unsupported flag to the DR daemon when the daemon tried to ascertain the configuration of a board.	Make sure that the version numbers match for the SSP and the DR daemon. Also, check the size of the daemon by using the <code>ps(1)</code> command. Normally, the daemon uses about 300- to 400-Kbytes of memory. If the daemon has grown far beyond the above memory sizes, then an internal error may have occur within it. You may have to stop and restart the DR daemon to recover from this error.
DR Error: libdevinfo failed.	The initial routine used to open the <code>libdevinfo</code> API failed, so the DR daemon could not explore the device tree for that board. The <code>libdevinfo</code> API builds a tree of dev-info nodes for a board as part of the DR daemon's exploration of the domain devices and their usage. The tree is required by AP and DR operations to test the detachability of a board I/O devices. It is also used to inform the user of what devices are on what system boards.	Make sure that the correct version of the <code>libdevinfo</code> is included on the domain and that a version mismatch does not exist between the DR daemon's libraries, the operating environment on the domain, or the DR daemon itself. If no cause can be found, report this error to your Sun service provider.
get_cpu_info: cpu state info is incomplete [non- fatal].	The DR daemon could not gather the states of the CPUs (either online or offline). Therefore, the information about each CPU in the CPU Configuration window will not be accurate.	None

TABLE A-10 System Exploration Error Messages (Continued)

Error Message	Probable Cause	Suggested Action
DR Error: build_rpc_info: bad slot number	The device tree was built incorrectly. Several functions create the device tree for a system board by searching through the /dev and /devices directories and by using the libdevinfo API. After the tree is built, it is passed to the build_rpc_info() function that performs some verification of the tree as it translates the DR daemon device tree into a structure that can be returned from an RPC.	Check the size of the DR daemon by using the ps(1) command. Normally, the daemon uses about 300- to 400-Kbytes of memory. If the daemon has grown far beyond the above memory sizes, then an internal error may have occur within it. You may have to stop and restart the DR daemon to resolve this error. Report this error to your Sun service representative, providing as much information from the system logs as possible.
DR Error: build_rpc_info: device address format error	The device tree was built incorrectly. Several functions create the device tree for a system board by searching through the /dev and /devices directories and by using the libdevinfo API. After the tree is built, it is passed to the build_rpc_info() function that performs some verification of the tree as it translates the DR daemon device tree into a structure that can be returned from an RPC.	Check the size of the DR daemon by using the ps(1) command. Normally, the daemon uses about 300- to 400-Kbytes of memory. If the daemon has grown far beyond the above memory sizes, then an internal error may have occur within it. You may have to stop and restart the DR daemon to resolve this error. Report this error to your Sun service representative, providing as much information from the system logs as possible.
DR Error: build_rpc_info: I/O bus node address format error	The device tree was built incorrectly. Several functions create the device tree for a system board by searching through the /dev and /devices directories and by using the libdevinfo API. After the tree is built, it is passed to the build_rpc_info() function that performs some verification of the tree as it translates the DR daemon device tree into a structure that can be returned from an RPC.	Check the size of the DR daemon by using the ps(1) command. Normally, the daemon uses about 300- to 400-Kbytes of memory. If the daemon has grown far beyond the above memory sizes, then an internal error may have occur within it. You may have to stop and restart the DR daemon to resolve this error. Report this error to your Sun service representative, providing as much information from the system logs as possible.

TABLE A-10 System Exploration Error Messages (Continued)

Error Message	Probable Cause	Suggested Action
DR Error: build_rpc_info: psycho number out of range	The device tree was built incorrectly. Several functions create the device tree for a system board by searching through the /dev and /devices directories and by using the libdevinfo API. After the tree is built, it is passed to the build_rpc_info() function that performs some verification of the tree as it translates the DR daemon device tree into a structure that can be returned from an RPC.	Check the size of the DR daemon by using the ps(1) command. Normally, the daemon uses about 300- to 400-Kbytes of memory. If the daemon has grown far beyond the above memory sizes, then an internal error may have occur within it. You may have to stop and restart the DR daemon to resolve this error. Report this error to your Sun service representative, providing as much information from the system logs as possible.
DR Error: build_rpc_info: sysio number out of range	The device tree was built incorrectly. Several functions create the device tree for a system board by searching through the /dev and /devices directories and by using the libdevinfo API. After the tree is built, it is passed to the build_rpc_info() function that performs some verification of the tree as it translates the DR daemon device tree into a structure that can be returned from an RPC.	Check the size of the DR daemon by using the ps(1) command. Normally, the daemon uses about 300- to 400-Kbytes of memory. If the daemon has grown far beyond the above memory sizes, then an internal error may have occur within it. You may have to stop and restart the DR daemon to resolve this error. Report this error to your Sun service representative, providing as much information from the system logs as possible.

OpenBoot PROM Error Messages

The following table contains the list of OpenBoot™ PROM (OBP) error messages that are sent to the system logs and/or to the SSP applications.

TABLE A-11 OBP Error Messages

Error Message	Probable Cause	Suggested Action
<code>cpu unit without upa-portid</code> [non-fatal]	This message indicates that corrupted or incorrect values were found in the OBP structures, meaning that the information in the OBP Configuration window will not be correct.	This is a non-fatal error. If this error persists, reboot the domain. If the error persists after the reboot, report it to your Sun service representative, providing as much information about the error as possible.
<code>OBP_info: bad child units</code> [non-fatal]	This message indicates that corrupted or incorrect values were found in the OBP structures, meaning that the information in the OBP Configuration window will not be correct.	This is a non-fatal error. If this error persists, reboot the domain. If the error persists after the reboot, report it to your Sun service representative, providing as much information about the error as possible.
<code>obp_info: bad slot number</code> [non-fatal]	This message indicates that corrupted or incorrect values were found in the OBP structures, meaning that the information in the OBP Configuration window will not be correct.	This is a non-fatal error. If this error persists, reboot the domain. If the error persists after the reboot, report it to your Sun service representative, providing as much information about the error as possible.
<code>obp_info: missing sbus name</code> [non-fatal]	This message indicates that corrupted or incorrect values were found in the OBP structures, meaning that the information in the OBP Configuration window will not be correct.	This is a non-fatal error. If this error persists, reboot the domain. If the error persists after the reboot, report it to your Sun service representative, providing as much information about the error as possible.

TABLE A-11 OBP Error Messages (*Continued*)

Error Message	Probable Cause	Suggested Action
obp_info: missing slot number [non-fatal]	This message indicates that corrupted or incorrect values were found in the OBP structures, meaning that the information in the OBP Configuration window will not be correct.	This is a non-fatal error. If this error persists, reboot the domain. If the error persists after the reboot, report it to your Sun service representative, providing as much information about the error as possible.
sbus node without upa-portid [non-fatal]	This message indicates that corrupted or incorrect values were found in the OBP structures, meaning that the information in the OBP Configuration window will not be correct.	This is a non-fatal error. If this error persists, reboot the domain. If the error persists after the reboot, report it to your Sun service representative, providing as much information about the error as possible.
sysio_num out of range [non-fatal]	This message indicates that corrupted or incorrect values were found in the OBP structures, meaning that the information in the OBP Configuration window will not be correct.	This is a non-fatal error. If this error persists, reboot the domain. If the error persists after the reboot, report it to your Sun service representative, providing as much information about the error as possible.
DR Error: cannot open /dev/openprom. . . <i>errno_description</i>	The DR daemon could not open the entry point for the domain's OBP information, meaning that no information will appear in the OBP Configuration window. This error is not fatal.	Determine what caused this error by using the <code>open(2)</code> man page and the <i>errno_description</i> . The DR daemon may have encountered a resource limit. If so, stop the daemon then restart it. Also, check the size of the DR daemon. It should be between 300- and 400-Kbytes. If it is not within this range, stop the daemon then restart it. If you cannot recover the domain from this error or symptoms of a memory leak exist, report this error to your Sun service representative, providing as much information from the system logs as possible.

TABLE A-11 OBP Error Messages (Continued)

Error Message	Probable Cause	Suggested Action
DR Error: close error on /dev/openprom	The DR daemon failed to close the entry point for the OBP driver.	Determine what caused this error by using the error messages that preceded this error message. Fix the error if possible.
DR Error: dev/openprom busy. Cannot open.	The entry point for the domain OBP information was busy, meaning that no information will appear in the OBP Configuration window. This error is non-fatal.	Retry the operation. Check for process that may be keeping the entry point open by using the <code>ps(1M)</code> command. Stop any processes that are keeping the entry point open.
DR Error: get_obp_board_config: invalid board state	Communication protocol was breached over the eligibility of a board when the SSP application tried to query the OBP information for a board. To the SSP, the board is part of the domain, so the SSP attempts to drain the board resources. However, to the DR driver and daemon, the board is not part of the domain.	None
DR Error: OBP config: too many CPUs	The DR daemon found too many CPUs attributed to a system board in the OBP structures. To OBP, the board has more CPUs than it could possibly have (for instance, five or more).	Ensure that OBP is operating properly. If it is not, reboot the domain.
DR Error: OPROMCHILD. . . <i>errno_description</i>	An <code>ioctl()</code> performed on the OBP driver entry point failed, specifically the <code>ioctl()</code> used to walk the child OBP node in the device tree, meaning that the information in the OBP Configuration window will not be complete.	Determine what caused this error by using the <i>errno_value</i> or the <i>errno_description</i> that accompanies this error message. Fix the error if possible.
DR Error: OPROMGETPROP. . . <i>errno_description</i>	An <code>ioctl()</code> performed on the OBP driver entry point failed, specifically the <code>ioctl()</code> used to acquire the OBP properties, meaning that the information in the OBP Configuration window will be incomplete.	Determine what caused this error by using the <code>ioctl(2)</code> man page and the <i>errno_description</i> that accompanies this error message. Fix the error if possible.

TABLE A-11 OBP Error Messages (Continued)

Error Message	Probable Cause	Suggested Action
DR Error: OPROMNEXT. . . <i>errno_description</i>	An <code>ioctl()</code> performed on the OBP driver entry point failed, specifically the <code>ioctr()</code> used to walk to the next OBP node in the device tree, meaning that the information in the OBP Configuration window will not be complete.	Determine what caused this error by using the <code>ioctl(2)</code> man page and the <i>errno_description</i> that accompanies this error message. Fix the error if possible.
DR Error: System architecture does not support this option of this command.	An unsupported option was given to the DR daemon as it walked the OBP tree for the domain, meaning that part of the information in the OBP Configuration window will be incorrect. This error is non-fatal.	None

Unsafe-Device Query Failures

The following table contains the list of unsafe-device query failure error messages that are sent to the system logs and/or to the SSP applications.

TABLE A-12 Unsafe-Device Query Error Messages

Error Message	Probable Cause	Suggested Action
unsafe_devices: couldn't determine name of unsafe device <i>major_number</i>	The mechanism that the DR daemon uses to combine a driver name with a major number failed so that no name could be discovered. If this failure occurs, the DR daemon constructs a string for the device, marking it as "(unknown, <i>major_number</i>)".	This message notifies the user that the DR daemon was unable to find the name of one of the devices, but it does not constitute a correctable error. The daemon can use the major number to identify the drive.

TABLE A-12 Unsafe-Device Query Error Messages (Continued)

Error Message	Probable Cause	Suggested Action
WARNING: board <i>board_number</i> not checked for unsafe devices.	While the DR daemon was examining the system boards for unsafe devices, the daemon encountered a failure that prevented it from examining one of the system boards (<i>board_number</i>). This error message may be indicative of a more serious problem.	You may have to stop and restart the DR daemon to recover the domain from this error. Check the size of the DR daemon. It should be between 300- and 400-Kbytes. If it is not within this range, stop the daemon, then restart it. If you cannot recover the domain from this error, you should report this error to your Sun service representative, providing as much information from the system logs as possible.
DR Error: unsafe_devices: libdevinfo failed.	The DR daemon cannot determine the names of unsafe major devices because it cannot use the libdevinfo API. This API must be used to search the device tree for the names of all of the unsafe major devices.	Make sure that the domain contains the correct version of the libdevinfo API and that the domain does not contain version mismatches between any of the DR daemon's libraries, the operating environment on the domain, or the daemon itself. If you cannot determine the cause of this error, report it to your Sun service representative, providing as much information from the system logs as possible.
DR Error: create_ctlr_array: count mismatch [internal error]	Communication protocol was breached over the existence of AP controllers. To the AP librarian, the domain has a certain number of AP controllers. However, to the DR daemon, the domain has a different number of AP controllers.	Check to determine the correct amount of AP controllers in the domain, and correct the error. Also, check the size of the DR daemon. It should be between 300- and 400-Kbytes. If it is not within this range, stop the daemon then restart it.

AP-Related Error Messages

The following table contains the list of Alternate Pathing error message that are sent to the system logs and/or to the SSP applications.

TABLE A-13 AP-Related Error Messages

Error Message	Probable Cause	Suggested Action
<code>add_net_ap_info: multiple AP aliases ignored</code>	An AP device has multiple AP aliases. Only one alias is used. The other aliases were ignored. This is not an error.	If this error persists, remove all but one of the AP aliases.
<code>AP daemon call failed: error_message *OR* error = error_number</code>	An attempt to notify and/or query the AP librarian failed.	A descriptive error message may be available to provide specific details about this failure, or an error number may be available. Also, check the <code>ap_daemon(1M)</code> man page for more details about this error.
<code>AP daemon comm init failed: error_message *OR* error = error_number</code>	The DR daemon encountered a failure when it tried to establish a channel of communication with the AP librarian. A descriptive error message may be available to provide specific details about this failure, or an error number may be available.	A descriptive error message may be available to provide specific details about this failure, or an error number may be available. Also, check the <code>ap_daemon(1M)</code> man page for more details about this error.
<code>AP daemon query failed: error_message *OR* error = error_number</code>	The DR daemon could not successfully query the AP librarian on the usage of a specific I/O controller. A descriptive error message may be available to provide specific details about this failure, or an error number may be available.	A descriptive error message may be available to provide specific details about this failure, or an error number may be available. Also, check the <code>ap_daemon(1M)</code> man page for more details about this error.
<code>AP daemon query failed: length mismatch</code>	The DR daemon queried the AP librarian about the usage of a specific I/O controller, but the response was incorrect.	A descriptive error message may be available to provide specific details about this failure, or an error number may be available. Also, check the <code>ap_daemon(1M)</code> man page for more details about this error.

TABLE A-13 AP-Related Error Messages (Continued)

Error Message	Probable Cause	Suggested Action
<p>Cannot find physical device for <i>AP_alias</i></p> <p>This error message is sent only to the system logs.</p>	<p>The physical device name that corresponds with the AP alias could not be found. AP may be confused about the device name, or the <code>/dev</code> and <code>/devices</code> directories are incomplete.</p>	<p>Make sure that AP works properly. Check to see if all of the device entries are present in the <code>/dev</code> and <code>/devices</code> directories. If they are not present, add them to the appropriate directories.</p>
<p><code>create_ap_net_leaf:</code> <code>interface instance not found</code></p>	<p>The DR daemon tries to match the AP metanetwork interfaces with the physical device they represent. This error indicates that the DR daemon could not successfully match a network interface with the physical device it represents for this board.</p>	<p>Make sure that AP works properly if you observe abnormal behavior regarding the availability of devices during and after DR operations. If this error persists, report it to your Sun service representative with as much information from the system logs as possible.</p>
<p><code>dr_ap_notify: unknown state state_number</code></p>	<p>The DR daemon called one of its internal functions with a bad value. However, this error is indicative of a more serious problem.</p>	<p>Report this error to your Sun service representative with as much information as possible from the system logs.</p>
<p><code>dr_daemon operating in NO AP interaction mode</code></p>	<p>The AP software is not working, or it is not installed. This message means that the DR daemon will not notify AP about attach and detach operations.</p>	<p>Ignore this error if you do not have AP installed. If it is installed, make sure that it is properly installed and that the AP software version is compatible with the version of the DR daemon that is running in the domain.</p>
<p><code>init_ap_rpc: Unable to get hostname</code></p>	<p>The <code>uname(2)</code> system call returned a null hostname. Consequently, the DR daemon could not establish a connection to the AP librarian.</p>	<p>None</p>

Index

A

- abort button, 19, 31
- active DR operations, only one, 2
- Alternate Pathing (AP) and DR, 4
- alternate pathing and vital partitions during detach, 4
- amount of memory attachable, 42
- AP (Alternate Pathing) and DR, 4
- AP / DR interaction, disabling, 9
- AP and Solstice DiskSuite, 4
- attach, 1
 - reconfiguration sequence after attach, 8
- attach buttons, 19
- attach, complete, 22
- attach, dynamic reconfiguration window, 21
- attach, parameter selection, 20
- attachable memory, 42
- attaching with dr(1M), 23
- automatically switching off active controllers during detach, 9

B

- blacklisting, alternative for detach-unsafe devices, 15
- board added, reconfigure after, 8
- board attach, 1
- board deleted, optionally reconfigure after, 8
- board detach, 1, 26
- board replaced, reconfigure after, 8

- board, attach, 20

buttons

- abort, 19, 31
- complete, 19, 22, 31, 34
- CPU, 39
- device, 43
- dismiss, 19, 31
- drain, 31, 33
- force, 31
- help, 19, 31
- init attach, 19, 21
- reconfig, 19, 31
- select, 20

C

- CEs (correctable memory errors) and detach, 6
- communication timeouts affecting Hostview and dr(1M), 10
- complete attach, 18, 22
- complete attach vi dr(1M), 25
- complete button, 19, 22, 31, 34
- complete detach, 27, 34
- complete detach via dr(1M), 37
- configuring for detach, 4
- configuring swap space I/O controllers across boards, 4
- connection, loss of, 10
- controllers (disk), number of, 8
- copying nonpageable memory before detach detach

- copying nonpageable memory before detach, 5
- correctable memory errors (CEs) and detach, 6
- CPU button, 39
- CPU configuration window, 39

D

- DDI/DKI, 14
- DDI_DETACH, 14
- DDI_DETACH support needed for detach, 5
- DDI_RESUME, 14, 15
- DDI_SUSPEND, 14, 15
- detach, 1, 26
 - configuring for detach, 4
 - configuring memory for detach, 5
 - correctable memory errors (CEs) and detach, 6
 - detaching detach-unsafe device, 14
 - devices must be closed before detach, 5
 - file systems unmounted before detach, 5
 - I/O controllers on board being detached, 4
 - interleaved memory and detach, 5
 - network between SSP and UE10000, and detach, 4
 - network controllers and detach, 4
 - nonpageable memory, determining if present, 6
 - pageable memory and swap space during detach, 7
 - RSM 2000 and detach, 14
 - Sun StorEdge A3000 and detach, 14
 - swap partitions must be deleted before detach, 5
 - swap space and detach, 4
 - switching of active controllers during detach, 9
- detach and network devices, 27
- detach and non-network devices, 28
- detach and processors, 30
- detach buttons, 31
- detach, parameter selection window, 32
- detaching with dr(1M), 34
- detaching with Hostview, 32
- detach-safe, 14
- detach-safe tape devices, 13
- detach-unsafe, 14
- detach-unsafe devices present, cannot force detach, 15

- dev, reconfiguring /dev links after DR operation, 8
- device button, 43
- device configuration window, 43
- device detail window, 44
- devices must be closed before detach, 5
- disabling AP / DR interaction, 9
- disk controller numbering, 8
- disk devices, reconfiguring after DR operation, 8
- disk swap space, and detach, 4
- dismiss button, 19, 31
- DR / AP interaction, disabling, 9
- DR attach, 1
- DR detach, 1, 26
- DR overview, 1
- DR parameter selection, 20
- DR suspend-safe device, 12
- DR suspend-unsafe device, 12
- DR unsafe devices, 47
- dr(1M), attaching via, 23
- drain, 26
- drain button, 33
- drain via dr(1M), 36
- drain, percent complete, 43
- draing button, 31
- drivers that support DR, 14
- drivers, listing of suspend-safe drivers, 12
- dr-max-mem environment variable, 42
- drshow example, 6
- drshow, dr(1M) command, 25
- dynamic reconfiguraiton window, detach, 33
- dynamic reconfiguration window, attach, 21

E

- environment variables
 - dr-max-mem, 42
- Ethernet between SSP and UE1000, and detach, 4

F

- file systems unmounted before detach, 5
- files
 - .postrc, and memory interleaving, 5

- st.conf (ST_UNLOADABLE flag and tape devices), 13
- force button, 31
- force quiesce, how to, 12
- forcible conditions and quiesce failures, 12

H

- hard lock on file systems (lockfs) before detach, 5
- help button, 19, 31
- Hostview, detaching via, 32

I

- I/O controllers on board being detached, 4
- I/O devices, configuring for detach, 4
- I/O devices, reconfiguring after DR operation, 8
- init attach, 17, 21
- init attach button, 19, 21
- init attach, with dr(1M), 24
- interleaved memory and detach, 5
- interleaved memory, determining if enabled, 5

L

- lock on file systems (lockfs) before detach, 5
- loss of connection, 10

M

- manually suspending suspend-unsafe devices, 12
- memory attach capacity, 42
- memory button
 - buttons
 - memory, 41
- memory configuration window, 41
- Memory Configuration window (Hostview), and nonpageable memory, 6
- memory draining, detach, 26
- memory interleaving, determining if enabled, 5
- memory reduction, detach, 42
- memory remaining in system, 42

- memory, configuring for detach, 5
- memory, determining if nonpageable memory is present, 6
- memory, pageable and nonpageable, 5
- memory, total size (all boards), 42

N

- network between SSP and UE1000, and detach, 4
- network controllers and detach, 4
- network devices and detach, 27
- network drivers, suspend-unsafe, 15
- non-network devices and detach, 28
- nonpageable and pageable memory, 5
- nonpageable memory and Memory Configuration window (Hostview), 6
- nonpageable memory, copying before detach, 5
- nonpageable memory, determining if present, 6
- nonpageable memory, target board for copying, 6
- numbering of disk controllers, 8

O

- overview of DR, 1

P

- pageable and nonpageable memory, 5
- pageable memory and swap space, during detach, 7
- parameter selection window, detach, 32
- parameter selection, attach, 20
- percent complete, drain, 43
- processors and detach, 30

Q

- quiesce affects only target domain, 11
- quiesce failures and forcible conditions, 12
- quiesce failures and transient conditions, 12
- quiesce OS during detach, and nonpageable memory, 5, 11

- quiesce OS, how to force, 12
- quiesce, reasons it may fail, 11
- quiescing OS and real-time processes, 11
- quiescing OS and suspend-unsafe devices, 11

R

- real-time processes and quiescing OS, 11
- reconfig button, 19, 31
- reconfiguration sequence after attach, 8
- reconfigure after board added, 8
- reconfigure after board deleted, optionally, 8
- reconfigure after board replaced, 8
- reconfiguring disk devices after DR operation, 8
- reconfiguring domain after DR operation, 8
- reconfiguring, when to, 8
- record-stop dumps and detach, 6
- reduction of memory, 42
- releasing system resources (DDI_DETACH support) needed for detach, 5
- remaining memory, detach, 42
- root partition and I/O controllers during detach, 4
- RPC timeout, 10
- RSM 2000 and detach, 14

S

- select button, 20
- Solstice DiskSuite and mirroring, 4
- SSP messages file, 1
- ST_UNLOADABLE flag and tape devices, 13
- StorEdge A3000 and detach, 14
- Sun StorEdge A3000 and detach, 14
- suspend-unsafe only target domain, 11
- suspend failures and forcible conditions, 12
- suspend failures and transient conditions, 12
- suspend OS, how to force, 12
- suspend, reasons it may fail, 11
- suspending OS and real-time processes, 11
- suspending OS and suspend-unsafe devices, 11
- suspending OS during detach, and nonpageable memory, 5, 11
- suspend-safe device, 12

- suspend-safe devices, 15
- suspend-safe drivers listing, 12
- suspend-unsafe device, 12
- suspend-unsafe device and quiescing OS, 11
- suspend-unsafe devices, 15
- suspend-unsafe devices, dealing with, 13
- suspend-unsafe devices, manually suspending, 12
- suspend-unsafe tape devices, 13
- swap partitions deleted before detach, 5
- swap space, configuring for detach, 7
- swap space, configuring I/O controllers across boards, 4
- switching off active controllers during detach, 9
- system board added, reconfigure after, 8
- system board deleted, optionally reconfigure after, 8
- system board replaced, reconfigure after, 8
- system board, target for copying nonpageable memory, 6
- system information, viewing, 37

T

- tape devices and ST_UNLOADABLE flag, 13
- tape devices, detach-safe, 13
- tape devices, suspend-unsafe, 13
- target board for nonpageable memory copy, 6
- target domain, attach, 20
- timeout, RPC, 10
- timeouts affecting Hostview and dr(1M), 10
- transient conditions and quiesce failures, 12

U

- unsafe devices, 47
- unsafe devices window, 47
- usr partition and I/O controllers during detach, 4

V

- viewing system information, 37

W

windows

- CPU configuration, 39
- detach parameter selection, 32
- device configuration, 43
- device detail, 44
- DR parameter selection, 20
- dynamic reconfiguration, 21
- memory configuration, 41
- unsafe devices, 47

