



# Sun Enterprise™ 10000 Dynamic Reconfiguration User Guide

---

Sun Microsystems, Inc.  
901 San Antonio Road  
Palo Alto, CA 94303-4900  
U.S.A. 650-960-1300

Part No. 806-5697-10  
September 2000, Revision A

Send comments about this document to: [docfeedback@sun.com](mailto:docfeedback@sun.com)

Copyright 2000 Sun Microsystems, Inc., 901 San Antonio Road, Palo Alto, California 94303-4900 U.S.A. All rights reserved.

This product or document is protected by copyright and distributed under licenses restricting its use, copying, distribution, and decompilation. No part of this product or document may be reproduced in any form by any means without prior written authorization of Sun and its licensors, if any. Third-party software, including font technology, is copyrighted and licensed from Sun suppliers.

Parts of the product may be derived from Berkeley BSD systems, licensed from the University of California. UNIX is a registered trademark in the U.S. and other countries, exclusively licensed through X/Open Company, Ltd. For Netscape Communicator™, the following notice applies: (c) Copyright 1995 Netscape Communications Corporation. All rights reserved.

Sun, Sun Microsystems, the Sun logo, AnswerBook2, docs.sun.com, Sun Enterprise, OpenBoot, and Solaris are trademarks, registered trademarks, or service marks of Sun Microsystems, Inc. in the U.S. and other countries. All SPARC trademarks are used under license and are trademarks or registered trademarks of SPARC International, Inc. in the U.S. and other countries. Products bearing SPARC trademarks are based upon an architecture developed by Sun Microsystems, Inc.

The OPEN LOOK and Sun™ Graphical User Interface was developed by Sun Microsystems, Inc. for its users and licensees. Sun acknowledges the pioneering efforts of Xerox in researching and developing the concept of visual or graphical user interfaces for the computer industry. Sun holds a non-exclusive license from Xerox to the Xerox Graphical User Interface, which license also covers Sun's licensees who implement OPEN LOOK GUIs and otherwise comply with Sun's written license agreements.

**RESTRICTED RIGHTS:** Use, duplication, or disclosure by the U.S. Government is subject to restrictions of FAR 52.227-14(g)(2)(6/87) and FAR 52.227-19(6/87), or DFAR 252.227-7015(b)(6/95) and DFAR 227.7202-3(a).

DOCUMENTATION IS PROVIDED "AS IS" AND ALL EXPRESS OR IMPLIED CONDITIONS, REPRESENTATIONS AND WARRANTIES, INCLUDING ANY IMPLIED WARRANTY OF MERCHANTABILITY, FITNESS FOR A PARTICULAR PURPOSE OR NON-INFRINGEMENT, ARE DISCLAIMED, EXCEPT TO THE EXTENT THAT SUCH DISCLAIMERS ARE HELD TO BE LEGALLY INVALID.

Copyright 2000 Sun Microsystems, Inc., 901 San Antonio Road, Palo Alto, Californie 94303 Etats-Unis. Tous droits réservés.

Ce produit ou document est protégé par un copyright et distribué avec des licences qui en restreignent l'utilisation, la copie, la distribution, et la décompilation. Aucune partie de ce produit ou document ne peut être reproduite sous aucune forme, par quelque moyen que ce soit, sans l'autorisation préalable et écrite de Sun et de ses bailleurs de licence, s'il y en a. Le logiciel détenu par des tiers, et qui comprend la technologie relative aux polices de caractères, est protégé par un copyright et licencié par des fournisseurs de Sun.

Des parties de ce produit pourront être dérivées des systèmes Berkeley BSD licenciés par l'Université de Californie. UNIX est une marque déposée aux Etats-Unis et dans d'autres pays et licenciée exclusivement par X/Open Company, Ltd. La notice suivante est applicable à Netscape Communicator™: (c) Copyright 1995 Netscape Communications Corporation. Tous droits réservés.

Sun, Sun Microsystems, le logo Sun, AnswerBook2, docs.sun.com, Sun Enterprise, OpenBoot, et Solaris sont des marques de fabrique ou des marques déposées, ou marques de service, de Sun Microsystems, Inc. aux Etats-Unis et dans d'autres pays. Toutes les marques SPARC sont utilisées sous licence et sont des marques de fabrique ou des marques déposées de SPARC International, Inc. aux Etats-Unis et dans d'autres pays. Les produits portant les marques SPARC sont basés sur une architecture développée par Sun Microsystems, Inc.

L'interface d'utilisation graphique OPEN LOOK et Sun™ a été développée par Sun Microsystems, Inc. pour ses utilisateurs et licenciés. Sun reconnaît les efforts de pionniers de Xerox pour la recherche et le développement du concept des interfaces d'utilisation visuelle ou graphique pour l'industrie de l'informatique. Sun détient une licence non exclusive de Xerox sur l'interface d'utilisation graphique Xerox, cette licence couvrant également les licenciés de Sun qui mettent en place l'interface d'utilisation graphique OPEN LOOK et qui en outre se conforment aux licences écrites de Sun.

CETTE PUBLICATION EST FOURNIE "EN L'ETAT" ET AUCUNE GARANTIE, EXPRESSE OU IMPLICITE, N'EST ACCORDEE, Y COMPRIS DES GARANTIES CONCERNANT LA VALEUR MARCHANDE, L'APTITUDE DE LA PUBLICATION A REPENDRE A UNE UTILISATION PARTICULIERE, OU LE FAIT QU'ELLE NE SOIT PAS CONTREFAISANTE DE PRODUIT DE TIERS. CE DENI DE GARANTIE NE S'APPLIQUERAIT PAS, DANS LA MESURE OU IL SERAIT TENU JURIDIQUEMENT NUL ET NON AVENU.

Sun Enterprise 10000 SSP Attributions:



This software is copyrighted by the Regents of the University of California, Sun Microsystems, Inc., and other parties. The following terms apply to all files associated with the software unless explicitly disclaimed in individual files.

The authors hereby grant permission to use, copy, modify, distribute, and license this software and its documentation for any purpose, provided that existing copyright notices are retained in all copies and that this notice is included verbatim in any distributions. No written agreement, license, or royalty fee is required for any of the authorized uses. Modifications to this software may be copyrighted by their authors and need not follow the licensing terms described here, provided that the new terms are clearly indicated on the first page of each file where they apply.

IN NO EVENT SHALL THE AUTHORS OR DISTRIBUTORS BE LIABLE TO ANY PARTY FOR DIRECT, INDIRECT, SPECIAL, INCIDENTAL, OR CONSEQUENTIAL DAMAGES ARISING OUT OF THE USE OF THIS SOFTWARE, ITS DOCUMENTATION, OR ANY DERIVATIVES THEREOF, EVEN IF THE AUTHORS HAVE BEEN ADVISED OF THE POSSIBILITY OF SUCH DAMAGE.

THE AUTHORS AND DISTRIBUTORS SPECIFICALLY DISCLAIM ANY WARRANTIES, INCLUDING, BUT NOT LIMITED TO, THE IMPLIED WARRANTIES OF MERCHANTABILITY, FITNESS FOR A PARTICULAR PURPOSE, AND NON-INFRINGEMENT. THIS SOFTWARE IS PROVIDED ON AN "AS IS" BASIS, AND THE AUTHORS AND DISTRIBUTORS HAVE NO OBLIGATION TO PROVIDE MAINTENANCE, SUPPORT, UPDATES, ENHANCEMENTS, OR MODIFICATIONS.

RESTRICTED RIGHTS: Use, duplication or disclosure by the government is subject to the restrictions as set forth in subparagraph (c) (1) (ii) of the Rights in Technical Data and Computer Software Clause as DFARS 252.227-7013 and FAR 52.227-19.

This is scotty, a simple tcl interpreter with some special commands to get information about TCP/IP networks. Copyright (c) 1993, 1994, 1995, J. Schoenwaelder, TU Braunschweig, Germany, Institute for Operating Systems and Computer Networks. Permission to use, copy, modify, and distribute this software and its documentation for any purpose and without fee is hereby granted, provided that this copyright notice appears in all copies. The University of Braunschweig makes no representations about the suitability of this software for any purpose. It is provided "as is" without express or implied warranty.



# Contents

---

**Preface** xiii

Before You Read This Book xiii

How This Book Is Organized xiii

Using UNIX Commands xiv

Typographic Conventions xv

Shell Prompts xv

Related Documentation xvi

Ordering Sun Documentation xvi

Accessing Sun Documentation Online xvi

Sun Welcomes Your Comments xvii

**1. Introduction to DR** 1

DR Operations 1

Memory 2

    Pageable and Nonpageable Memory 2

    Target Memory Constraints 3

    Correctable Memory Errors 3

    ▼ To Re-Enable Dump Detection 4

DR and IDNs 4

RPC Time-Out or Loss of Connection 5

## **2. Using Dynamic Reconfiguration 7**

Attaching a System Board 7

Init Attach 8

Complete Attach 8

Attach Buttons 9

▼ To Attach a Board With Hostview 9

▼ To Attach a Board By Using `dr(1M)` 13

Detaching a System Board 16

Drain 16

Complete Detach 17

Hostview Detach Buttons 18

▼ To Detach a Board With Hostview 19

▼ To Detach a Board By Using `dr(1M)` 22

Viewing Domain Information 25

▼ To View Domain Information with Hostview 26

▼ To Specify How Windows Are Updated 26

▼ To View DR CPU Configuration Information 27

▼ To View DR Memory Configuration Information 29

▼ To View DR Device Configuration Information 31

▼ To View DR Device Detailed Information 32

▼ To View DR OBP Configuration Information 33

▼ To View the DR-Unsafe Devices 34

### **A. SSP DR Error Messages 37**

Searching This Appendix 37

Error-Type Links 38

Protocol and Communication Error Messages 38

Attach-Related Failures	44
Detach-Related Error Messages	45
Auto-Configuration Error Messages	50





# Figures

---

- FIGURE 2-1 Attach Board and Domain Selection Window 10
- FIGURE 2-2 Dynamic Reconfiguration Window With `init attach` Button 11
- FIGURE 2-3 Dynamic Reconfiguration Window With the `complete` Button 12
- FIGURE 2-4 Detach—Board and Domain Selection Window 20
- FIGURE 2-5 Dynamic Reconfiguration Window With the `drain` Button 21
- FIGURE 2-6 System Information Buttons 26
- FIGURE 2-7 DR Properties Window 27
- FIGURE 2-8 DR CPU Configuration Window 28
- FIGURE 2-9 DR Memory Configuration Window 29
- FIGURE 2-10 DR Device Configuration Window 31
- FIGURE 2-11 DR Detail Device Window 32
- FIGURE 2-12 DR OBP Configuration Window 34
- FIGURE 2-13 DR Unsafe Devices Window 35



# Tables

---

TABLE 2-1	Hostview Buttons	18
TABLE 2-2	DR CPU Configuration Information	28
TABLE 2-3	DR Memory Configuration Information	30
TABLE A-1	Protocol and Communication Failure Error Messages	38
TABLE A-2	Attach-Related Failure Error Messages	44
TABLE A-3	Detach-Related Failure Error Messages	45
TABLE A-4	Auto-Configuration Error Messages	50



# Preface

---

This book describes the Dynamic Reconfiguration (DR) feature, which enables you to logically attach and detach system boards from the Sun Enterprise™ 10000 server while other domains continue running.

---

## Before You Read This Book

This book is intended for the Sun Enterprise 10000 server system administrator who has a working knowledge of UNIX® systems, particularly those based on the Solaris™ operating environment. If you do not have such knowledge, first read the Solaris user and system administrator books in AnswerBook2™ format provided with this system and consider UNIX system administration training.

---

## How This Book Is Organized

This book contains the following chapters:

Chapter 1 introduces basic concepts related to the Dynamic Reconfiguration feature.

Chapter 2 describes how to use DR to attach and detach system boards.

Appendix A contains DR error messages that occur on the SSP (system services processor).

---

# Using UNIX Commands

This document may not contain information on basic UNIX commands and procedures such as shutting down the system, booting the system, and configuring devices.

Refer to one or more of the following for this information:

- AnswerBook2 online documentation for the Solaris software environment
- Other software documentation that you received with your system

---

# Typographic Conventions

Typeface or Symbol	Meaning	Examples
AaBbCc123	The names of commands, files, and directories; on-screen computer output	Edit your <code>.login</code> file. Use <code>ls -a</code> to list all files. % You have mail.
<b>AaBbCc123</b>	What you type, when contrasted with on-screen computer output	% <b>su</b> Password:
<i>AaBbCc123</i>	Book titles, new words or terms, words to be emphasized	Read Chapter 6 in the <i>User's Guide</i> . These are called <i>class</i> options. You <i>must</i> be superuser to do this.
	Command-line variable; replace with a real name or value	To delete a file, type <code>rm filename</code> .

---

---

# Shell Prompts

Shell	Prompt
C shell	<i>machine_name</i> %
C shell superuser	<i>machine_name</i> #
Bourne shell and Korn shell	\$
Bourne shell and Korn shell superuser	#

---

---

## Related Documentation

Application	Title	Part Number
User	<i>Sun Enterprise 10000 SSP 3.4 User Guide</i>	806-4870
	<i>Sun Enterprise 10000 DR Configuration Guide</i>	806-5228
Reference	<i>Sun Enterprise 10000 SSP 3.4 Reference Manual</i>	806-4871
	<i>Sun Enterprise 10000 Dynamic Reconfiguration Reference Manual</i>	806-4123
	<i>Sun Enterprise 10000 DR Error Messages</i>	806-5229
Release Notes	<i>Solaris 8 11/00 Release Notes Supplement for Sun Hardware</i>	Printed in Media Kit.

---

## Ordering Sun Documentation

Fatrain.com, an Internet professional bookstore, stocks select product documentation from Sun Microsystems, Inc.

For a list of documents and how to order them, visit the Sun Documentation Center on Fatrain.com at:

<http://www1.fatrain.com/documentation/sun>

---

## Accessing Sun Documentation Online

The [docs.sun.com](http://docs.sun.com)<sup>SM</sup> web site enables you to access Sun technical documentation on the Web. You can browse the [docs.sun.com](http://docs.sun.com) archive or search for a specific book title or subject at:

<http://docs.sun.com>



---

# Sun Welcomes Your Comments

We are interested in improving our documentation and welcome your comments and suggestions. You can email your comments to us at:

`docfeedback@sun.com`

Please include the part number (806-5697-10) of your document in the subject line of your email.



# Introduction to DR

---

Dynamic Reconfiguration (DR) enables you to logically attach and detach system boards to and from the operating system without causing machine downtime. DR is used in conjunction with hot swap, which is the process of physically removing or inserting a system board. You can use DR to add a new system board, reinstall a repaired system board, or modify the domain configuration on the Sun Enterprise 10000 system.

If a system board is being used by a domain, you must detach it before you can power it off and remove it. After a new or upgraded system board is inserted and powered on, you may attach it to the domain.

---

## DR Operations

You can execute DR operations from the SSP through the Hostview GUI or the `dr(1M)` shell application (refer to the `hostview(1M)` and `dr(1M)` man pages for more information). DR supports the following operations:

- **DR attach** – Logically attaches a system board to the operating system running in a domain. A system board is logically attached when its resources—processors, memory, and I/O adapters—are configured into a domain and are available to the Solaris operating environment. The system board must already be present in the system, powered on, and not be a member of a domain. Normally, you attach a system board after it is inserted and powered on by your service provider or after it is detached from another domain.
- **DR detach** – Logically detaches a system board from a domain. A system board is logically detached when its resources—processors, memory, and I/O adapters—are removed from the domain configuration and are no longer available to the domain. Normally, you detach a system board to either move it to another domain or prepare it for removal.

While DR operations are being performed within a domain, the `dr_daemon(1M)` (refer to the *Sun Enterprise 10000 Dynamic Reconfiguration Reference Manual*) and the operating environment write messages regarding the status or exceptions of DR requests to the domain syslog message buffer (`/var/adm/messages`) and the SSP message files (`$SSPOPT/adm/host/messages` and `$SSPOPT/adm/messages`). In addition to the status and exception information displayed by Hostview and the `dr(1M)` shell application, the `dr_daemon(1M)` and operating environment messages are useful for determining the status of DR requests.

---

**Note** – Only one DR operation per platform can be active at any time. A DR operation that is partially completed and then dismissed within one domain does not prevent a subsequent DR operation from being started in a different domain. A partially completed DR operation must be finished before a subsequent DR operation is permitted in the same domain.

---

---

## Memory

If you use memory interleaving between system boards, those system boards cannot be detached because DR does not yet support interboard interleaving. By default, `hpost(1M)` does not set up boards with interleaved memory. Look for the following line in the `hpost(1M)` file `.postrc` (see `postrc(4)`):

```
mem_board_interleave_ok
```

If `mem_board_interleave_ok` is present, you may not be able to detach a board that uses memory interleaving.

## Pageable and Nonpageable Memory

Before you can detach a board, the operating system must vacate the memory on that board. Vacating a board means flushing its pageable memory to swap space and copying its nonpageable (that is, kernel and OBP memory) to another memory board. To relocate nonpageable memory, the operating environment on a domain must be temporarily suspended, or quiesced. The length of the suspension depends on the domain I/O configuration and the running workloads. Detaching a board with nonpageable memory is the only time when the operating environment is suspended; therefore, you should know where nonpageable memory resides, so you

can avoid significantly impacting the operation of the domain. When permanent memory is on the board, the operating environment must find other memory to receive the copy.

You can use the `dr(1M)` command `drshow(1M)` to determine if the memory on a board is pageable or nonpageable:

```
% dr
dr> drshow board_number mem
```

Similarly, you can determine if the memory on a board is pageable by looking at the DR Memory Configuration window, which is available when you perform a detach operation within Hostview. The DR Memory Configuration window is described in the *Sun Enterprise 10000 DR Configuration Guide* in the Solaris 8, Update 3, Sun Hardware Answerbook Collection.

## Target Memory Constraints

When permanent memory is detached, DR chooses a target memory area to receive a copy of the memory. The DR software automatically checks for total adherence. It does not allow the DR memory operation to continue if it cannot verify total adherence. A DR memory operation might be disallowed because of the following reasons:

- The domain is not large enough to hold a copy of the nonpageable memory.
- The domain is interleaved with memory on other boards.

In the Solaris 7 5/99 release, if no target board is found, the detach operation is refused, and DR displays an error message (refer to the *Sun Enterprise 10000 DR Error Messages* document for more information about the message).

## Correctable Memory Errors

Correctable memory errors indicate that the memory on a system board (that is, one or more of its Dual Inline Memory Modules (DIMMs), or portions of the hardware interconnect) may be faulty and need replacement. When the SSP detects correctable memory errors, it initiates a record-stop dump to save the diagnostic data, which can interfere with a DR detach operation. Therefore, Sun Microsystems suggests that when a record-stop occurs from a correctable memory error, you allow the record-stop dump to complete its process before you initiate a DR detach operation.

If the faulty component causes repeated reporting of correctable memory errors, the SSP performs multiple record-stop dumps. If this happens, you should temporarily disable the dump-detection mechanism on the SSP, allow the current dump to finish, then initiate the DR detach operation. After the detach operation finishes, you should re-enable the dump detection.

## ▼ To Re-Enable Dump Detection

1. **Log in to the SSP as the user `ssp`.**
2. **Disable record-stop dump detection:**

```
SSP% edd_cmd -x stop
```

This command suspends all event detection on all of the domains.

3. **Monitor the in-progress record-stop dump:**

```
SSP% ps -ef | grep hpost
```

In the `grep(1)` output, the `-D` option of `hpost` indicates that a record-stop dump is in progress.

4. **Perform the DR detach operation.**
5. **Enable event detection:**

```
SSP% edd_cmd -x start
```

---

## DR and IDNs

The IDN feature allows domains to communicate to each other over the interconnect by using standard TCP/IP protocols. To provide this capability, the IDN feature maintains detailed information about the hardware configuration and is dependent on the hardware configuration of the member domains.

The DR feature allows the user to reconfigure the hardware while the operating system is running. Thus, DR is required to make an IDN aware of the changes so that the IDN can maintain consistent, up-to-date information about the hardware.

DR accomplishes this requirement by unlinking the domain from the IDN, reconfiguring the hardware, and relinking the domain to the IDN. The unlinking and relinking of the domain occurs during the complete attach or complete detach phase of the DR operation. DR determines if the domain is a member of an IDN, and it performs the unlinking and relinking of the domain during the complete phase. No interaction is needed by the user. However, if a member domain is in an unknown state (that is, AWOL), the unlink operation will not succeed, especially if the domain is in a non-responsive state. If one or more domains were in an unknown state when you attempted to perform a DR operation, you must unlink all of the AWOL domains within the IDN in a single step (that is, use the `domain_unlink(1M)` command with all of the names of the AWOL domains).

During the period in which the domain is not linked to the IDN, no transmission to or from the domain are allowed. In contrast, the domain remains a member of the IDN as defined in the `domain_config(4)` file on the SSP, and the domain continues to be listed as a member of the IDN when you use the `domain_status(1M)` command.

---

**Note** – Due to the interaction between the DR and IDN features, only one DR or IDN operation is allowed at any given time within a single Sun Enterprise 10000 system.

---

Certain conditions may require you to use the force option. In the context of a DR operation, you can use the DR force option, which is passed to the `domain_unlink(1M)` command. When used on a domain that is a member of an IDN, the force option should be used with extreme care. Refer to the *Sun Enterprise 10000 InterDomain Networks User Guide* for more information about the force option and its use.

---

## RPC Time-Out or Loss of Connection

The `dr_daemon(1M)`, which runs in each domain, communicates with Hostview and the `dr(1M)` shell application (both of which run on the SSP) by way of Remote Procedure Calls (RPCs).

For more information about RPC time-outs and loss of connection failures, refer to the *Sun Enterprise 10000 DR Configuration Guide*.





## Using Dynamic Reconfiguration

---

This chapter contains information and procedures on how to use the Sun Enterprise Dynamic Reconfiguration feature.

---

**Note** – For information and procedures on how to configure and reconfigure the domain before and after a DR operation, refer to the *Sun Enterprise 10000 DR Configuration Guide* in the Solaris 8, Update 3, Sun Hardware Answerbook2™ Collection.

---

---

## Attaching a System Board

This section gives a broad overview of the actions that occur when you execute DR attach. For step-by-step instructions, see “To Attach a Board With Hostview”.

You can attach system boards that are present in the machine, powered on, and not part of an active domain (that is, not being used by an operating environment). These unattached boards may have been hot-swapped into the domain after the domain was booted, blacklisted when the domain was booted, or detached from another domain.

---

**Note** – If the system board has been hot-swapped into the domain, you should use the `thermal_config(1M)` command immediately after the board has been powered on.

---

Prior to attaching a board, diagnostics are run on the board, requiring that at least one processor be present on the board and not be blacklisted. After you have selected an eligible board and a target domain, the DR attach operation proceeds through two operations: `init attach` and `complete attach`.

## Init Attach

During the init attach phase, DR diagnoses and configures the selected board, preparing it and its devices for attachment to the operating environment. During this phase, DR performs the following tasks:

- Adds the board to the board list of the target domain in the `domain_config(4)` file on the SSP.
- Runs `hpost -H` on the board to configure it. `hpost(1M)` isolates the board on the Sun Enterprise 10000 system centerplane by placing it into a single-board hardware domain (refer to the `hpost(1M)` man page).

---

**Note** – Depending on the presence on memory and I/O devices on the board, the `hpost` testing level could be different for subsequent attach operations.

---

- Runs `obp_helper -H` which loads `download_helper` to the board, and takes the processors on the board out of reset mode, allowing them to spin in `download_helper`.
- Reconfigures the centerplane and board domain mask registers, placing the board in the target hardware domain.

DR displays the output of these `hpost(1M)` and `obp_helper(1M)` operations, including the steps that succeeded and those that caused exceptions.

If `hpost(1M)` and `obp_helper(1M)` succeed, the operating system is notified and requests OBP to probe the board. The operating environment then scans the OBP device tree and adds the devices to its configuration, but the drivers are not loaded.

After the init attach phase is completed, the OBP board configuration can be displayed to confirm which devices are present on the board. You can then enter the complete attach phase, or you can abort the operation.

If you abort the operation, DR removes the board configuration from the operating environment data structures and removes the board from the `domain_config(4)` file, leaving the board in a state where it is not assigned to any domain. The board can then be removed from the system by using hot swap, left in the system unattached, or attached at a later time.

## Complete Attach

During the complete attach phase, DR attempts to complete the attach operation by making the resources that are hosted by the new system board available to the operating environment. If a problem occurs that prevents the attachment of any

device on the board, the `dr_daemon(1M)` logs that problem in the system message buffer. To determine which devices were successfully attached, display and check the domain configuration for the board.

After a board is successfully attached, you have the option of reconfiguring the I/O devices. Refer to “Reconfiguration After a DR Operation” in the *Sun Enterprise 10000 DR Configuration Guide* for more information. This operation can take several minutes to complete.

## Attach Buttons

When you perform an attach operation using the Hostview GUI (which transparently calls a separate executable: `drview(1M)`), the following buttons appear at various times during the attach process:

- **init attach** – Begins the attach operation (see “Init Attach” on page 8). After the operation has completed successfully, the label on this button changes to `complete`.
- **complete** – Completes the attach operation (see “Complete Attach” on page 8).
- **reconfig** – Automatically reconfigures the device directories in the domain. You may want to run the reconfiguration operation after attaching a board (refer to “Reconfiguration After a DR Operation” in the *Sun Enterprise 10000 DR Configuration Guide*).
- **abort** – Cancels the attach operation. This button is enabled after the `init attach` operation has been successfully completed (see “Init Attach” on page 8).
- **dismiss** – Terminates the step that is currently in progress, but leaves the board in its current state (Present, `init attach`, In Use). You can remove the DR attach window by choosing `dismiss` at any point during the attach operation. The `dismiss` button terminates any work being done on the SSP for the attach operation. For example, if `hpost(1M)` is running when you click `dismiss`, that `hpost(1M)` process is terminated. Note that `dismiss` does not terminate work being done on the host by way of RPCs to the `dr_daemon(1M)`. After an RPC is initiated, the host completes the RPC regardless of whether or not the calling program is waiting for the RPC to finish. The host `dr_daemon(1M)` keeps track of the progress of the attach operation. After the `init attach` operation completes successfully, it remembers this state. Therefore, you can `dismiss` the window, then return to the DR operation later and `complete` or `abort` the attach.
- **help** – Accesses online information regarding DR attach operations.

### ▼ To Attach a Board With Hostview

---

**Note** – Before you perform the following steps, you should read “Attaching a System Board” on page 7.

---

1. **From Hostview, select the proper view of the system from the View menu.**  
Choose the view that contains the board you want to attach.
2. **From Hostview, select the board you want to attach.**
3. **From Hostview, choose Configuration > Board > Attach.**

The attach Board and Domain Selection window is displayed (FIGURE 2-1 on page 10).

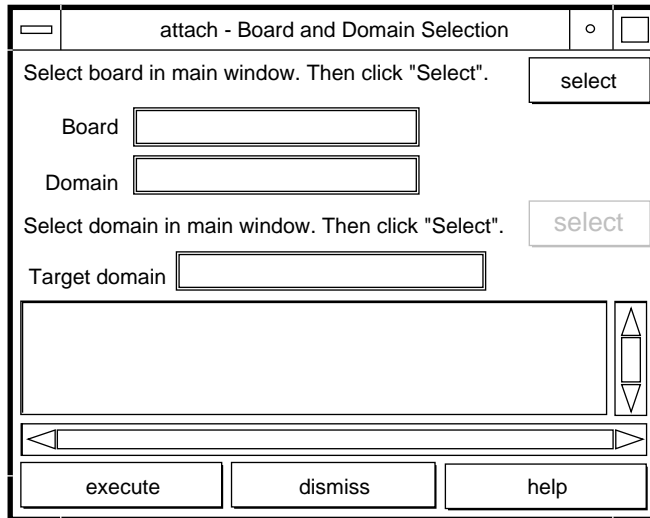
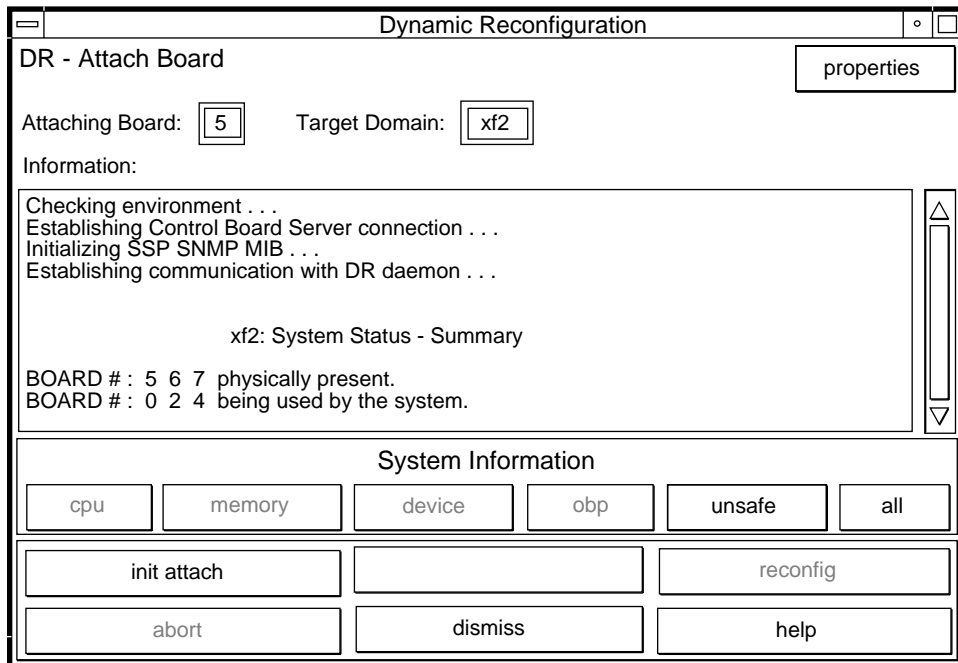

FIGURE 2-1 Attach Board and Domain Selection Window

4. **Click the top select button.**  
The Board field is automatically filled in for you. If the board is part of a domain, the Domain field is also filled in for you. (You can also manually edit these fields.)
5. **In the main Hostview window, use the View menu to select the domain to which you want to attach the board.**
6. **Click the bottom Select button.**  
The Target Domain field is automatically filled in for you. (You can also manually edit that field.)
7. **Click the execute button.**  
If any errors occur, the error messages appear in the main Hostview window. Otherwise, the Dynamic Reconfiguration window is displayed with the init attach button visible (FIGURE 2-2 on page 11).



**FIGURE 2-2** Dynamic Reconfiguration Window With `init attach` Button

## 8. Click the `init attach` button.

Clicking on the `init attach` button begins the first phase of the board attach process. First, the system updates the `SSP domain.config(4)` file by adding the system board to the board list of the target domain. Next, the system uses `hpost(1M)` to self-test the system board. After the self-test is complete, the board is made visible to the running target domain by merging it into the hardware domain by modifying the centerplane and the system board hardware registers. Finally, during the conclusion of the `init attach`, OBP probes the new board to discover what CPU, I/O, and memory resources are present on the board. When this phase is finished, the caption on the button changes to `complete`. Before you click the `complete` button, however, you may want to view the domain information to verify that you want to proceed, as described in “Viewing Domain Information” on page 25.

Typically, the `init attach` operation can take a few minutes to complete. Output from the `hpost(1M)` command is directed to the Information pane of the Dynamic Reconfiguration window.

If the `init attach` fails, look for the cause in the output in the Information pane. After you have determined the cause, you may want to choose `init attach` again.

If the `init attach` operation completes successfully, the window changes to that shown in FIGURE 2-3 on page 12, with the `complete` button enabled.

**9. Click the complete button.**

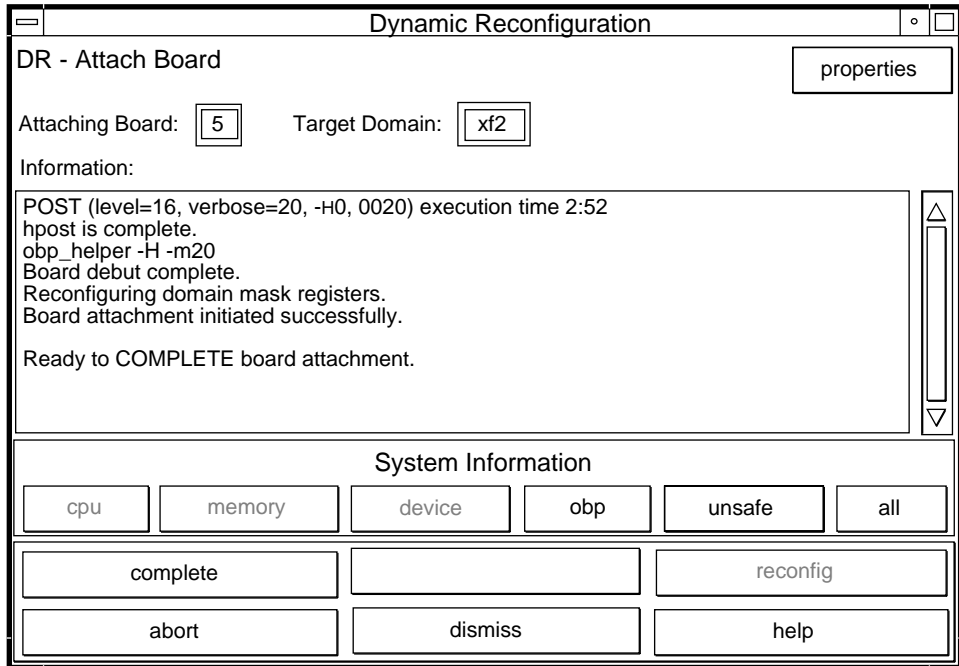

**FIGURE 2-3** Dynamic Reconfiguration Window With the `complete` Button

The complete operation normally takes less than one minute to finish. When it has successfully completed, DR displays the following message:

```
Board attachment completed successfully
```

The system board resources—processors, memory, and I/O devices—are now available to the operating system.

You can view the domain information about the newly attached board by using the buttons (CPU, Memory, Device, and so forth), as described in “Viewing Domain Information” on page 25.

---

**Caution** – Before you choose the `reconfig` button, be sure to read “Reconfiguration After a DR Operation” in the *Sun Enterprise 10000 DR Configuration Guide*.

---

**10. Click the dismiss button.**

The DR attach operation is complete.

## ▼ To Attach a Board By Using dr(1M)

Before you perform the following steps, read “Attaching a System Board” on page 7. The process of attaching a board is very similar whether you use Hostview or dr(1M). The basic concepts are not repeated in this section.

The dr(1M) shell was introduced in Chapter 1. A quick reference guide is available in the dr(1M) application by using the help command.

1. Set `SUNW_HOSTNAME` to the appropriate domain by using the `domain_switch(1M)` command.

```
% domain_switch domain_name
```

2. Use the dr(1M) command in an SSP Window to bring up the dr(1M) prompt.

In the following example, the target domain is called xf3.

```
% dr
Checking environment...
Establishing Control Board Server connection...
Initializing SSP SNMP MIB...
Establishing communication with DR daemon...

      xf3: Domain Status - Summary

BOARD #: 0 1 2 5 6 8 9 10 11 13 physically present.
BOARD #: 4 7 being used by the domain.
dr>
```

### 3. Begin the `init_attach(1M)` operation for the designated board.

In this example, board 6 is being attached to `xf3` domain.

```
dr> init_attach 6
Initiate attaching board 6 to domain xf3.
Adding board 6 to domain_config file.
/opt/SUNWssp/bin/hpost -H40,28
Opening SNMP server library...

Significant contents of /export/home/ssp/.postrc:
blacklist_file ./bf
redlist_file ./rf
Reading centerplane asics to obtain bus configuration...
Bus configuration established as 3F.
phase cplane_isolate: CP domain cluster mask clear...
...
phase final_config: Final configuration...
Configuring in 3F, FOM = 2048.00: 4 procs, 4 SCards, 1024 MBytes.
Creating OBP handoff structures...
Configured in 3F with 4 processors, 4 SBus cards, 1024 MBytes
memory.
Interconnect frequency is 83.294 MHz, from SNMP MIB.
Processor    frequency is 166.631 MHz, from SNMP MIB.
Boot processor is 6.0 = 24
POST (level=16, verbose=20, -H28,0040) execution time 3:07
hpost is complete.
obp_helper -H -m24
Board debut complete.
Reconfiguring domain mask registers.
Board attachment initiated successfully.

Ready to COMPLETE board attachment.
```

### 4. Abort or complete the attach operation.

- After the system successfully completes the `init_attach(1M)` operation, you can use the `drshow(1M)` OBP display to see an inventory of the board resources.

```
dr> drshow board_number OBP
```

- If you wish to abort the attach operation, use the `abort_attach(1M)` command.

```
dr> abort_attach board_number
```



- If you wish to complete the board attach operation, use the `complete_attach(1M)` command.

```
dr> complete_attach 6
Completing attach for board 6.
...Checking IDN state of domain_name_a : UP
Issuing IDN UNLINK (domain_name_a)
Verifying IDN UNLINK...
IDN (XM) UNLINK succeeded (domain_name)
...Checking IDN state of domain_name_a : UP
...Checking IDN state of domain_name_b : UP
Initiating IDN LINK...
IDN LINK succeeded (domain_name_a + domain_name_b)
Board attachment completed successfully.
dr>
```

After you successfully attach the board, all of the `drshow(1M)` displays become available.

#### 5. Use the `drshow(1M)` to display the I/O information for the newly attached board.

```
dr> drshow 6 IO

      SBus Controllers and Devices for Board 6

----- Sbus 0 : Slot 0 : SUNW,pln0 -----

device      opens  name                      usage
-----      -
ssd0         0      /dev/dsk/clt0d0s0
ssd16        0      /dev/dsk/clt1d0s0
ssd32        0      /dev/dsk/clt2d0s0
ssd48        0      /dev/dsk/clt3d0s0
ssd64        0      /dev/dsk/clt4d0s0
ssd80        0      /dev/dsk/clt5d0s0

----- Sbus 0 : Slot 1 : SUNW,pln2 -----

device      opens  name                      usage
-----      -
ssd96        0      /dev/dsk/c2t0d0s0
ssd97        0      /dev/dsk/c2t0d1s0
...
```

**6. Type `exit` to terminate this `dr(1M)` session.**

```
dr> exit
%
```

The SSP login shell prompt is again displayed.

---

## Detaching a System Board

This section gives a broad overview of the actions that occur when you execute DR detach. For step-by-step instructions, see “To Detach a Board With Hostview” on page 19.

System boards that are currently being used by the operating environment can be detached if they meet the requirements covered in “Configuration for DR Detach” in the *Sun Enterprise 10000 DR Configuration Guide*. After you select an eligible board, you can detach that board by performing two operations: drain and complete detach.

### Drain

The primary function of the drain operation is to determine how the board’s memory is to be vacated by the operating environment and, if required, to select a target memory area for copying the nonpageable memory on a board. If a suitable target memory area is not available when the drain operation is requested, the request is denied. If the drain is rejected for this reason, you can continue to retry until target memory is available. Refer to “Configuration for DR Detach” in the *Sun Enterprise 10000 DR Configuration Guide*.

After the drain operation is started, the pageable memory on the board is flushed to a disk, which removes it from use by the domain. Whenever a page of memory becomes free, that page is locked from further use. The drain has no noticeable impact on the processes using the CPU and I/O resources on the board. However, less memory is available to the domain.

---

**Note** – After memory is drained, enough memory and swap space must remain in the domain to accommodate the current workloads.

---

During the drain period, Hostview and `dr(1M)` are available to monitor the detach progress. You can view the current status of the drain operation, including the number of memory pages remaining to be drained, and the usage of devices on the board. With this information, you can prepare the domain for detaching the remaining board devices.

If you decide not to proceed with the detach operation, you can abort the operation, and the memory on the board is returned to regular usage. You can also abort the operation during the drain process or after the drain has been completed. If extreme memory pressure exists during the drain, you will see little, or no, progression in the percentage of drained pages, and you may want to abort the drain and wait until the workload on the domain has decreased, enabling it to accommodate the reduction in memory.

The drain operation is complete when all of the memory pages are free from usage. You can then complete the detach operation.

## Complete Detach

Before you can complete the detach operation, you must terminate all usage of board resources (processors, memory, and I/O devices). DR terminates the use of memory, processors, and network devices automatically, but you must terminate the use of all non-network I/O devices.

---

**Note** – To identify the components that are on the board to be detached, use `drshow(1M)`, which is an option of the `dr(1M)` command, or use the display windows in Hostview (select the `Configuration` menu and then choose the `Board` pull-down menu and the `Detach` menu item). Another somewhat less informative way to identify the components is to use the `prtdiag(1M)` command on the domain.

---

After all board usage is terminated, you can perform the complete detach operation. If a device is still in use at this time, the detach operation fails and the device in use is reported. After you resolve the problem, you can perform the complete detach operation again.

If the board that you want to detach contains nonpageable memory, the complete detach operation may also fail due to quiescence problems, which are described in “System Quiescence Operation” in the *Sun Enterprise 10000 DR Configuration Guide*. After you resolve the quiescent problem, you can again execute the complete detach operation.

If you decide that you do not want to proceed with the detach operation at this time, you can abort the detach. The memory on a board is returned to normal usage and detached board devices are reattached. If the system configuration was modified to

remove board usage (that is, file systems were unmounted and networks were unplumbed), you must undo these modifications and return the devices to normal operation.

After the board is successfully detached from the operating environment, it is isolated from the centerplane. In addition, the board list is automatically updated in the SSP `domain_config(4)` file.

You can now attach the board to another domain, power it off, and remove it by way of hot-swapping, leaving it in the system unattached, or reattaching it at a later time.

## Hostview Detach Buttons

The Hostview detach window displays the following buttons at various times during a detach operation:

**TABLE 2-1** Hostview Buttons

Button	Description
drain	Drains the memory (see “Drain” on page 16). After the drain operation is finished, the drain button becomes the complete button.
complete	Completes the detach operation after the board has been fully drained (see “Complete Detach” on page 17).
force	Permits you to complete the detach operation by forcibly quiescing the domain (refer to “System Quiescence Operation” in the <i>Sun Enterprise 10000 DR Configuration Guide</i> ). If the complete detach operation fails due to a forcible quiesce condition, the force button is enabled.
reconfig	Reconfigures device directories in a domain automatically. You may want to run reconfig after permanently detaching a board. Use reconfig with extreme caution (refer to “Reconfiguration After a DR Operation” in the <i>Sun Enterprise 10000 DR Configuration Guide</i> for more information).

**TABLE 2-1** Hostview Buttons (Continued)

Button	Description
abort	Cancels the DR operation, and returns the board to normal operation. This button is enabled after the drain operation starts and remains enabled until the complete detach operation starts. To stop the draining of memory and cancel the detach, choose abort (see “Detaching a System Board” on page 16).
dismiss	Cancels any step that is in progress, and leaves the board in its current state (In Use, drain, Present). At any point during the DR detach operation you can remove the DR detach window by choosing dismiss which terminates any work being done on the SSP for the detach operation. Note that dismiss does not terminate work being done on the host through RPC calls to the <code>dr_daemon(1M)</code> . After an RPC call is initiated, the host completes the RPC call regardless of whether or not Hostview is waiting for the RPC call to finish. The host <code>dr_daemon(1M)</code> keeps track of the progress of the detach operation. After the drain is started, it remembers this state. Therefore, you can dismiss the window and then return later to either complete or abort the detach operation.
help	Accesses online information regarding DR detach operations.

## ▼ To Detach a Board With Hostview

---

**Note** – Before you execute the following steps, read “Detaching a System Board” on page 16.

---

- 1. From the Hostview window, use the View menu to select the domain in which the board is attached.**
- 2. Click the icon of the board you want to detach.**
- 3. From the Hostview menu, choose Configuration > Board > Detach.**

The Detach Board and Domain Selection window is displayed (FIGURE 2-4 on page 20).

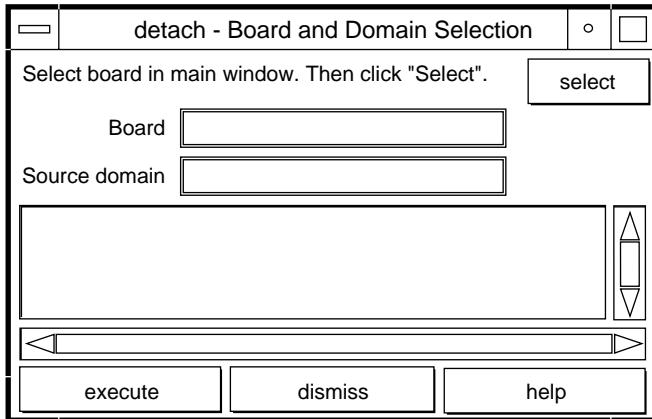

**FIGURE 2-4** Detach—Board and Domain Selection Window

**4. Click the select button.**

The Board and Source domain fields are automatically filled in for you. (You can also manually edit these fields if you wish.)

**5. Click the execute button.**

If the target domain is not currently booted, the detach operation simply manipulates the domain configuration file on the SSP. However, if the domain is running, the following window is displayed (FIGURE 2-5 on page 21).

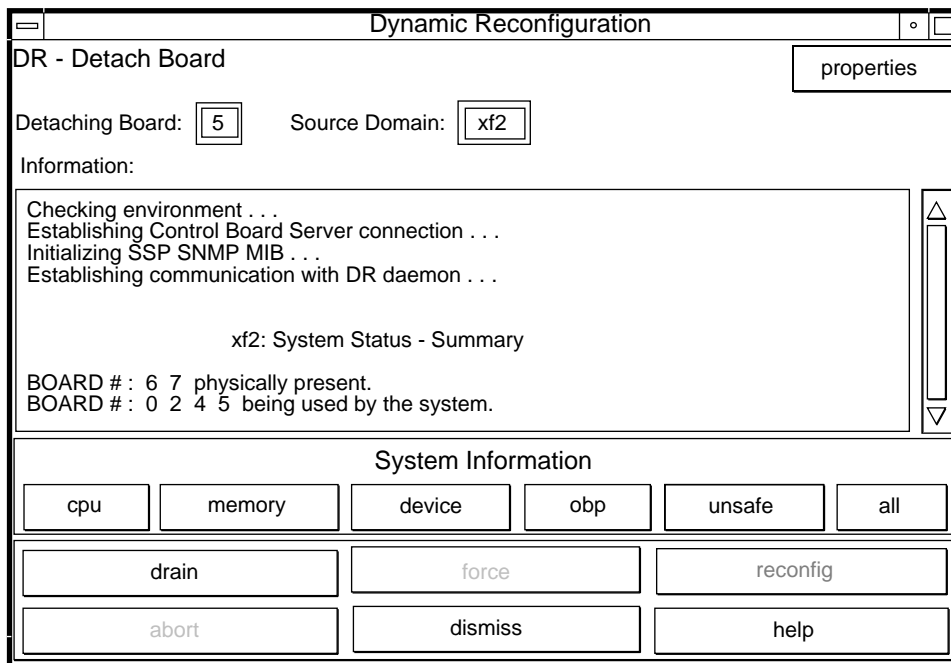

**FIGURE 2-5** Dynamic Reconfiguration Window With the drain Button

**6. Click the drain button.**

Hostview begins draining memory. The memory information is displayed and enables you to monitor the progress of the drain operation.

The memory drain statistics are automatically updated at periodic intervals if you enable the Auto Update Domain Information Displays option in the DR Properties window, as described in “Viewing Domain Information” on page 25.

If the drain operation fails, an explanatory message appears in the Information pane. After you have determined the cause, and corrected it, you can choose drain again.

You may proceed to the next step without waiting; it does not depend on completion of the drain.

**7. To determine which devices are active on the board, click the device button.**

The DR Device Configuration window is displayed and is periodically updated, providing you with a current snapshot of device usage.

**8. Terminate all usage of board-resident I/O devices.**

For more information, see “Complete Detach” on page 17.

When the complete button is displayed, DR is finished draining the memory, and you can proceed to the next step.

## 9. Select the complete button.

This operation may take several minutes to complete, particularly if an operating environment quiescence is necessary. When it is finished, the board devices are detached from the operating system.

If your attempt to complete the detach fails, it may be due to any of the following reasons:

- All online processors in the domain are on the board being detached.
- The board you want to detach contains the last processor in the “default” processor set. You must add an additional processor from another system board before you retry the detach operation.
- Primary network interfaces are on the board being detached. You must stop all usage of these networks manually (see “Complete Detach” on page 17).
- All usage of the I/O devices on the board you want to detach has not been stopped. The Information pane identifies the device on which the error was encountered (see “Complete Detach” on page 17).
- The operating environment quiescence failed. You must determine and resolve the cause of the error (refer to “System Quiescence Operation” in the *Sun Enterprise 10000 DR Configuration Guide*).

After you have resolved the reason for the failure, you can select either complete or force to complete the detach. If there are no further problems, the board is detached and reset. When the board is successfully detached, the following message is displayed:

```
Board detachment completed successfully.
```

---

**Caution** – Before you choose the reconfig button, you should read “Reconfiguration After a DR Operation” in the *Sun Enterprise 10000 DR Configuration Guide*.

---

You can now either reconfigure the device directories or dismiss the detach window. The board can be powered off and removed by hot-swapping, or it can be attached to another domain, left in the system unattached, or reattached at a later time.

### ▼ To Detach a Board By Using `dr(1M)`

Before you execute the following steps, read “Detaching a System Board” on page 16. The process of detaching a board is very similar with either Hostview or `dr(1M)`. The basic concepts are not repeated in this section. The `dr(1M)` program was introduced in Chapter 1.

1. **Set `SUNW_HOSTNAME` to the appropriate domain using the `domain_switch(1M)` command.**



2. Use the `dr(1M)` command in an SSP Window to bring up the `dr(1M)` prompt.  
In the following example, the target domain is called `xf3`.

```
% dr
Checking environment...
Establishing Control Board Server connection...
Initializing SSP SNMP MIB...
Establishing communication with DR daemon...

xf3: Domain Status - Summary

BOARD #: 0 1 2 5 6 8 9 10 11 13 physically present.
BOARD #: 4 7 being used by the domain.
dr>
```

### 3. Use the `drain(1M)` to drain the board.

```
dr> drain 6
Removing board 6 from domain_config file.
Start draining board 6
Board drain started. Retrieving Domain Info...

    Bound Processes for Board 6

cpu    user  sys  procs
----  -
24      0    1
25      0    1
26      0    1
27      0    1

    Active Devices for Board 6

device    opens  name                usage
-----  -
ssd384      0  /dev/rdisk/c5t0d0s4  AP database

    Memory Drain for Board 6 - IN PROGRESS

Reduction= 1024 MBytes
Remaining in Domain= 1024 MBytes
Percent Complete= 99% (5696 KBytes remaining)

Drain operation started at Wed Oct 09 18:06:00 1996
Current time                Wed Oct 09 18:06:34 1996
Memory Drain is in progress. When Drain has finished,
you may COMPLETE the board detach.

dr>
```

The `drain(1M)` command initiates the drain operation and returns to the shell prompt immediately. You can monitor the progress of the drain operation with the following command:

```
dr> drshow board_number drain
```

---

**Note** – In addition, you can initiate the drain with the `wait` option of the `drain(1M)` command, which does not return to the shell prompt until after the drain has completed. Refer to `drain(1M)` for more information regarding the `wait` option.

---

**4. After the drain operation has finished successfully, use the `complete_detach(1M)` command to complete the detach.**

```
dr> complete_detach 6
Completing detach of board 6
...Checking IDN state of domain_name_a : UP
Issuing IDN UNLINK (domain_name_a)
Verifying IDN UNLINK...
IDN (XM) UNLINK succeeded (domain_name)
Operating System has detached the board.
Reconfiguring domain mask registers.
...Checking IDN state of domain_name_a : UP
...Checking IDN state of domain_name_b : UP
Initiating IDN LINK...
IDN LINK succeeded (domain_name_a + domain_name_b)
Board 6 placed into loopback.
Board detachment completed successfully.
dr>
```

If the `complete_detach` fails with the message “Operating system failed to quiesce due to forcible conditions” and if you have determined the root cause of the quiescent failure, you can retry the `complete_detach` with the `force` option. (You can see the console messages to help determine the cause of the quiescent failure.) Refer to `complete_detach(1M)` for more information.

You can abort the detach operation, rather than complete it. To do so, use the command `abort_detach board_number`, instead of the `complete_detach` command shown above.

---

## Viewing Domain Information

Both `dr(1M)` and `Hostview` enable you to display information about the suspend-unsafe devices as well as information about the board selected during DR operations. For `dr(1M)`, this information is accessible by using the `drshow(1M)` command. From `Hostview`, this information is available by clicking the `cpu`, `memory`, `device`, `obp`, and `unsafe` buttons in the `attach` or `detach` windows.

---

**Note** – You should view and use the domain information *before* you attempt to drain the memory on the board.

---

The informational content is the same for both `dr(1M)` and `Hostview`. Note that the `cpu`, `memory`, and `device` displays are only enabled when the board is attached to the operating environment. When the `cpu`, `memory`, and `device` displays are available, they always contain accurate information. The `obp` display shows the information known to OBP, but it is not as detailed as the other three displays. This section shows how to use the displays.

## ▼ To View Domain Information with Hostview

1. Click on any of the **System Info** buttons during the DR operation (FIGURE 2-6).

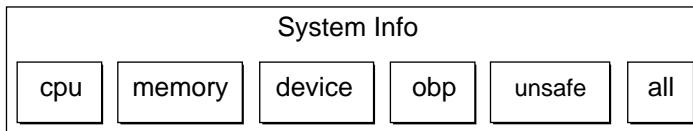

**FIGURE 2-6** System Information Buttons

When you click any of these buttons, a window is displayed, and it remains open until you click the dismiss button within that window.

If you click the `All` button, all of the currently enabled windows are displayed.

## ▼ To Specify How Windows Are Updated

1. Click the **Properties** button in the **Dynamic Reconfiguration** window (FIGURE 2-7).

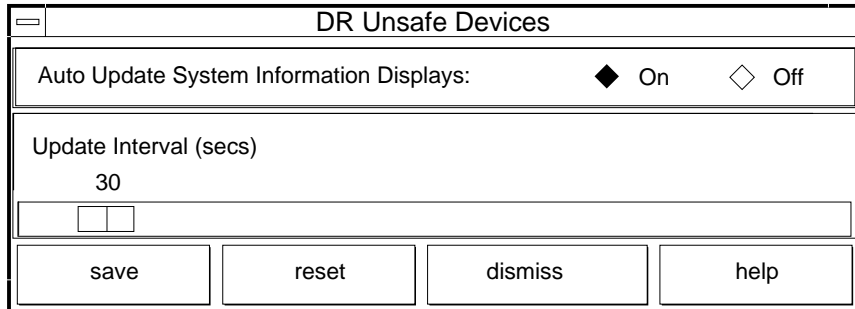

FIGURE 2-7 DR Properties Window

2. To cause displays to be updated, set Auto Update Domain Information Displays to On (the default).
3. Set the Update Interval to a value (in seconds) to determine how often updates occur.  
If you set Auto Update Domain Information Displays to Off, the displays are not updated; each display is a snapshot taken at the time the button was pressed.
4. Click the Save button to save the settings between Hostview invocations.

---

**Note** – When the update interval is set to a low value, such as 10 seconds, and several information windows are displayed, responsiveness of the DR windows may be degraded. This is especially true when device detail windows are displayed. Each time an information window is updated, an RPC is issued to the `dr_daemon(1M)` running on the domain. The `dr_daemon` is an iterative RPC server, so each RPC request is run sequentially.

---

## ▼ To View DR CPU Configuration Information

1. Click the **cpu** button.

The DR CPU Configuration window is displayed (FIGURE 2-8).

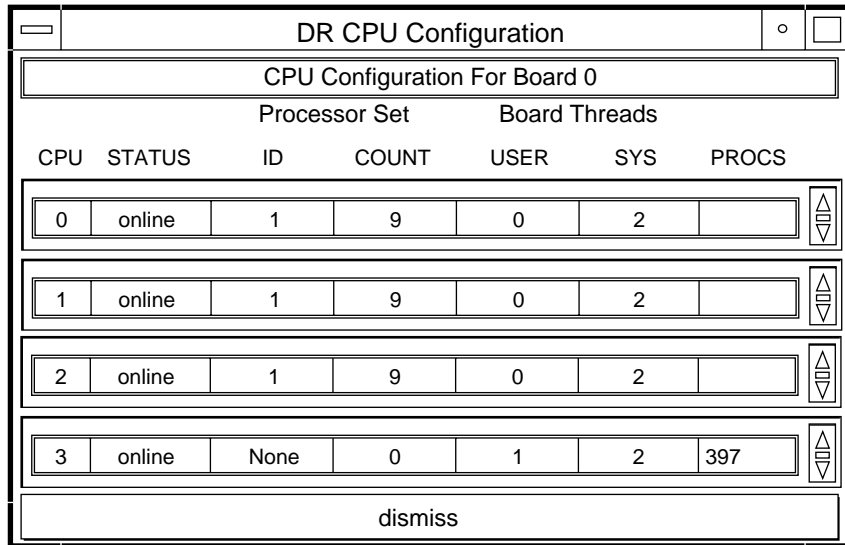

**FIGURE 2-8** DR CPU Configuration Window

The DR CPU Configuration window shows specific information about each processor on the selected board.

**TABLE 2-2** DR CPU Configuration Information

Heading	Description
CPU ID	Displays the ID number of the selected board.
STATUS	Displays the status of the selected board (that is, whether the board is online or offline).
Processor Set	ID - Displays the ID number of the processor set to which the processor belongs. If the processor belongs to the default set, the word none appears in the box. COUNT - Displays the number of CPUs in the processor set.
Bound Threads	Displays the number of user and system bound threads and the process IDs of the bound threads. Some operating system device drivers may bind threads to processors to provide better servicing of a device. Threads may be bound to a processor by use of the <code>pbind(1M)</code> command.
PROCS	Displays the process IDs of the user processes that are bound to a CPU.

## ▼ To View DR Memory Configuration Information

### 1. Click the memory button.

The DR Memory Configuration window is displayed (FIGURE 2-9).

DR Memory Configuration	
System Memory Sizes (MB)	
Current System:	2048
Attached Capacity:	63488
dr-max-mem:	65536
Memory Detach:	enabled
Memory Configuration for Board 0	
Memory Size(MB):	1024
Interleave Board:	no interleave
Physical Pages:	9437184-9568255
Board contains all pageable memory.	
Memory Drain for Board 0	ESTIMATED
Reduction:	1024
Remaining in System:	1024
Percent Complete:	
Drain Start Time:	
Current Time:	
dismiss	

FIGURE 2-9 DR Memory Configuration Window

The DR Memory Configuration window is divided into three panels:

**TABLE 2-3** DR Memory Configuration Information

---

System Memory Sizes (Domain Memory Information)

Current Domain	Total size of memory in the domain from all boards
Attach Capacity	Amount of memory that can be added by using the DR attach operation
dr-max-mem	Current value of the OBP variable dr-max-mem (for more information, refer to “dr-max-mem Variable” in the <i>Sun Enterprise 10000 DR Configuration Guide</i> )

Memory Configuration for Board 0 (Board-Level Information)

Memory Size (MB)	Amount of memory on the selected board
Interleave Board	Board that the selected board is interleaved with
Physical Pages	Highest and lowest physical pages that are occupied by the memory on this board (Small memory areas in the middle of this range may not be used by this board. Note that DR is not able to detach boards that have interleaved memory.)

Status/State (the display depends on the status/state of the operation)

Unavailable	A suitable target memory area is not currently available.
Estimated	The estimated values are displayed prior to starting the drain operation. The values displayed reflect the memory configuration that would result if the drain operation were started at this point. Note that the estimated values may differ from the in-progress values depending on the domain memory usage at the time drain was started.
In Progress	The drain operation is in progress.
Complete	The drain operation is finished.

Memory Drain Information

Reduction	Amount of memory to be removed from domain usage when the board is detached
Remaining in Domain	Domain memory size after the board is detached

---



**TABLE 2-3** DR Memory Configuration Information (*Continued*)

---

Percent Complete	How far the drain operation has progressed. Note that the time required to drain each memory page is not constant. Some memory pages take longer to drain than others.
Drain Start Time	The time the drain operation was started.
Current Time	The current time, which can be compared to the drain start time to see how long the drain operation has been in progress.

---

## ▼ To View DR Device Configuration Information

### 1. Click the device button.

The DR Device Configuration window is displayed (FIGURE 2-10).

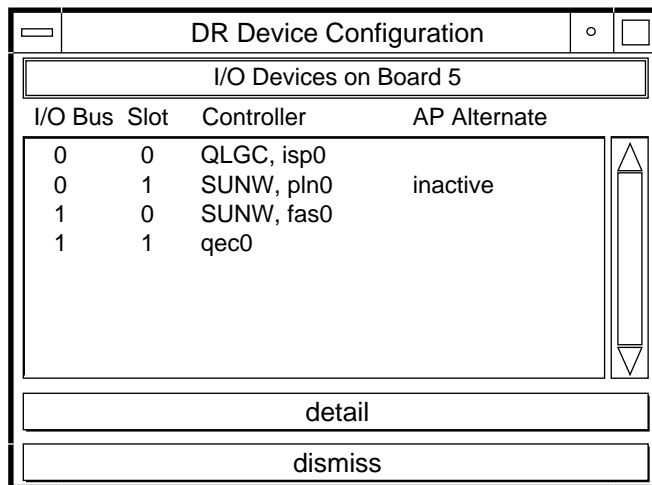

**FIGURE 2-10** DR Device Configuration Window

The controllers or devices in each slot are listed. The controller and device names are a concatenation of their device name and their operating environment instance number (for example, `sd31`).

---

**Note** – The DR Device Configuration window may not show all of the devices that are physically present on the board. For example, controllers whose drivers are unattached do not appear in the list. The device display that is available by using the `obp` button lists the cards on the board that were successfully probed and identified.

---

## ▼ To View DR Device Detailed Information

1. Highlight one or more controller(s).
2. Choose Detail.

The following window is displayed for each selected controller (FIGURE 2-11).

Device	Opens	Name	Usage
ssd80	0	/dev/dsk/c0t5d0s0	
ssd81	0	/dev/dsk/c0t5d1s0	
ssd82	0	/dev/dsk/c0t5d2s0	
ssd83	31	/dev/dsk/c0t5d3s0	/
ssd83	0	/dev/dsk/c0t5d3s1	swap, /tmp
ssd83	10	/dev/dsk/c0t5d3s3	/var
ssd83	1	/dev/dsk/c0t5d3s5	/opt
ssd83	25	/dev/dsk/c0t5d3s6	/usr
ssd83	0	/dev/dsk/c0t5d3s7	/export
ssd84	0	/dev/dsk/c0t5d4s0	

FIGURE 2-11 DR Detail Device Window

The current usage information for each device is shown. The window includes an open count (if available) and the common name (for example, a disk partition, a metadvice, or an interface name) by which the device is known. Additional usage information is also provided, including the partition mount points, network interface configuration, swap space usage, and metadvice usage.

---

**Note** – Some device usage, such as disk partitions used for Sun Solstice DiskSuite databases, Alternate Pathing databases, and Sun Enterprise Volume Manager usage, may not be reported.

---

If a controller or network interface is part of the AP database, the window indicates that it is active or that it is an AP alternate. For active AP alternates, the usage of the AP metadvice is displayed.

## ▼ To View DR OBP Configuration Information

---

**Note** – The information in the DR OBP Configuration window is derived from the OBP device tree, and is less detailed than the information that is available from the other windows described in this section. For example, in the init attach state, only the I/O adapters are known—not the devices attached to those controllers nor the memory interleave configuration. This window is usually used when a board is in the init attach state.

---

### 1. Click the **obp** button.

The DR OBP Configuration window is displayed (FIGURE 2-12).

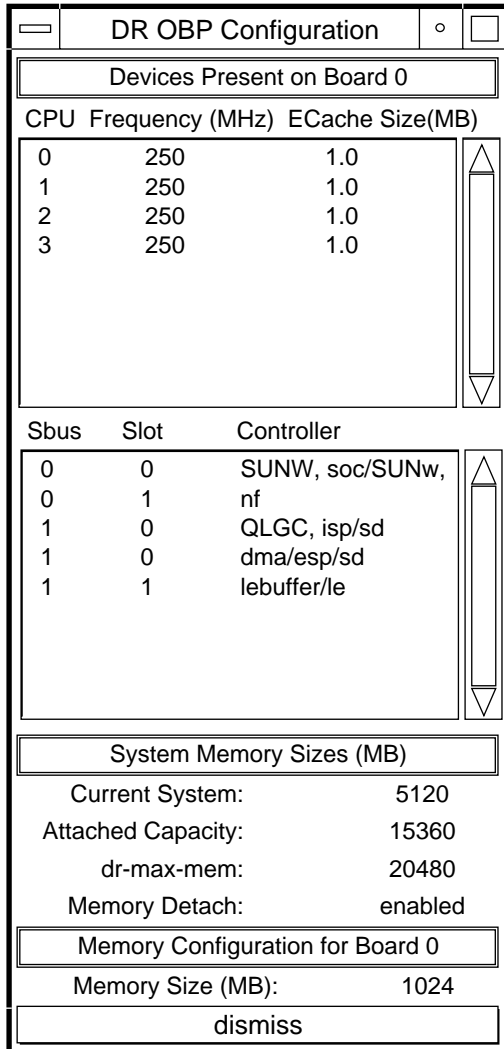
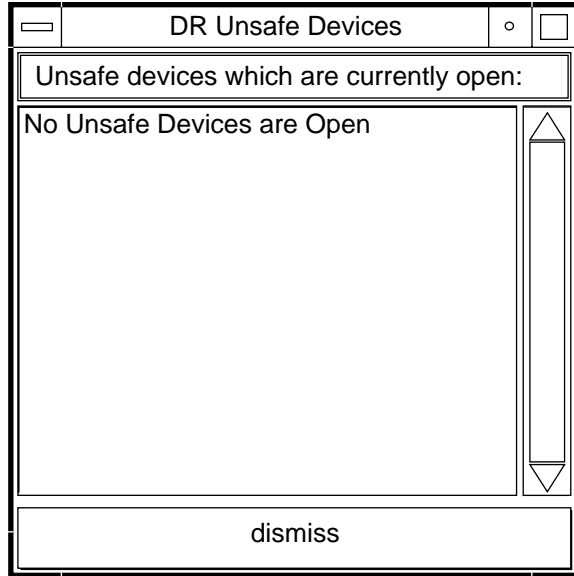

FIGURE 2-12 DR OBP Configuration Window

## ▼ To View the DR-Unsafe Devices

### 1. Click the unsafe button.

The DR Unsafe Devices window is displayed (FIGURE 2-13).



**FIGURE 2-13** DR Unsafe Devices Window

The DR Unsafe Devices window shows the suspend-unsafe devices that are open across the entire domain, not just those that are resident on the selected system board. This information is useful for determining the cause of operating environment quiescence errors due to unsafe devices being open.



## SSP DR Error Messages

---

This appendix contains a list of some of the error messages that you might see while you are performing DR operations. The list does not include Protocol Independent Module (PIM) layer errors, which are more generic than the error messages in the following tables.

---

**Note** – If you do not find the error message in this appendix, refer to the *Sun Enterprise 10000 DR Error Messages* book in the Solaris 8, Update 3, Sun Hardware Answerbook collection.

---

All DR error messages are sent to the one or both of the following locations:

- SSP applications
- System error logs

---

## Searching This Appendix

Before you use this appendix, take time to read the following list of search tips so that you can find a specific message.

- Search on a specific string of text in the error message.
- Avoid using numeric values. They are treated as replaceable text in this appendix.
- Avoid using text that is replaceable. In this appendix, the following names are used to represent replaceable text in the error messages: *descriptive message*, *errno\_description*, *device\_name*, *target\_path*, *mount\_point*, *interface\_name\_instance*, *interface\_name*, and *partition\_name*.
- If you are reading this text in hard-copy form, the tables are presented in order by the type of error or failure. The contents of the tables is sorted alphabetically in descending order.

## Error-Type Links

Use one of the following links to start your search.

“Protocol and Communication Error Messages” on page 38

“Attach-Related Failures” on page 44

“Detach-Related Error Messages” on page 45

“Auto-Configuration Error Messages” on page 50

---

## Protocol and Communication Error Messages

The following table contains the protocol and communication error messages that are sent to the system logs and/or the SSP applications.

**TABLE A-1** Protocol and Communication Failure Error Messages

Error Message	Probable Cause	Suggested Action
DR Error: abort_attach_board: invalid board number  This error message is sent to the system logs and to the SSP applications.	The RPC is attempting to perform a DR operation on a board number that is not in the range of valid numbers. The DR applications carefully filter the user input to catch out-of-range board numbers before they send the RPC. Therefore, this error indicates a breakdown on the SSP or in the network connection to the SSP. Or, it indicates an incompatibility between the SSP applications and the DR daemon.	Check the SSP network connection and/or the SSP and DR applications to ensure that they are operating properly.



**TABLE A-1** Protocol and Communication Failure Error Messages (Continued)

Error Message	Probable Cause	Suggested Action
<p>DR Error:  <code>abort_detach_board: invalid board number</code></p> <p>This error message is sent to the system logs and to the SSP applications.</p>	<p>The RPC is attempting to perform a DR operation on a board number that is not in the range of valid numbers. The DR applications carefully filter the user input to catch out-of-range board numbers before they send the RPC. Therefore, this error indicates a breakdown on the SSP or in the network connection to the SSP. Or, it indicates an incompatibility between the SSP applications and the DR daemon.</p>	<p>Check the SSP network connection and/or the SSP and DR applications to ensure that they are operating properly.</p>
<p>DR Error: <code>attach_finished: invalid board number</code></p> <p>This error message is sent to the system logs and to the SSP applications.</p>	<p>The RPC is attempting to perform a DR operation on a board number that is not in the range of valid numbers. The DR applications carefully filter the user input to catch out-of-range board numbers before they send the RPC. Therefore, this error indicates a breakdown on the SSP or in the network connection to the SSP. Or, it indicates an incompatibility between the SSP applications and the DR daemon.</p>	<p>Check the SSP network connection and/or the SSP and DR applications to ensure that they are operating properly.</p>
<p>DR Error:  <code>complete_attach_board: invalid board number</code></p> <p>This error message is sent to the system logs and to the SSP applications.</p>	<p>The RPC is attempting to perform a DR operation on a board number that is not in the range of valid numbers. The DR applications carefully filter the user input to catch out-of-range board numbers before they send the RPC. Therefore, this error indicates a breakdown on the SSP or in the network connection to the SSP. Or, it indicates an incompatibility between the SSP applications and the DR daemon.</p>	<p>Check the SSP network connection and/or the SSP and DR applications to ensure that they are operating properly.</p>

**TABLE A-1** Protocol and Communication Failure Error Messages (Continued)

<b>Error Message</b>	<b>Probable Cause</b>	<b>Suggested Action</b>
DR Error: cpu0_move_finished: invalid board number  This error message is sent to the system logs and to the SSP applications.	The RPC is attempting to perform a DR operation on a board number that is not in the range of valid numbers. The DR applications carefully filter the user input to catch out-of-range board numbers before they send the RPC. Therefore, this error indicates a breakdown on the SSP or in the network connection to the SSP. Or, it indicates an incompatibility between the SSP applications and the DR daemon.	Check the SSP network connection and/or the SSP and DR applications to ensure that they are operating properly.
DR Error: detach_board: invalid board number  This error message is sent to the system logs and to the SSP applications.	The RPC is attempting to perform a DR operation on a board number that is not in the range of valid numbers. The DR applications carefully filter the user input to catch out-of-range board numbers before they send the RPC. Therefore, this error indicates a breakdown on the SSP or in the network connection to the SSP. Or, it indicates an incompatibility between the SSP applications and the DR daemon.	Check the SSP network connection and/or the SSP and DR applications to ensure that they are operating properly.
DR Error: detach_finished: invalid board number  This error message is sent to the system logs and to the SSP applications.	The RPC is attempting to perform a DR operation on a board number that is not in the range of valid numbers. The DR applications carefully filter the user input to catch out-of-range board numbers before they send the RPC. Therefore, this error indicates a breakdown on the SSP or in the network connection to the SSP. Or, it indicates an incompatibility between the SSP applications and the DR daemon.	Check the SSP network connection and/or the SSP and DR applications to ensure that they are operating properly.

**TABLE A-1** Protocol and Communication Failure Error Messages (Continued)

<b>Error Message</b>	<b>Probable Cause</b>	<b>Suggested Action</b>
<code>DR Error: detachable_board: invalid board number</code>  This error message is sent to the system logs and to the SSP applications.	The RPC is attempting to perform a DR operation on a board number that is not in the range of valid numbers. The DR applications carefully filter the user input to catch out-of-range board numbers before they send the RPC. Therefore, this error indicates a breakdown on the SSP or in the network connection to the SSP. Or, it indicates an incompatibility between the SSP applications and the DR daemon.	Check the SSP network connection and/or the SSP and DR applications to ensure that they are operating properly.
<code>DR Error: drain_board_resources: invalid board number</code>  This error message is sent to the system logs and to the SSP applications.	The RPC is attempting to perform a DR operation on a board number that is not in the range of valid numbers. The DR applications carefully filter the user input to catch out-of-range board numbers before they send the RPC. Therefore, this error indicates a breakdown on the SSP or in the network connection to the SSP. Or, it indicates an incompatibility between the SSP applications and the DR daemon.	Check the SSP network connection and/or the SSP and DR applications to ensure that they are operating properly.
<code>DR Error: get_board_config: invalid board number</code>  This error message is sent to the system logs and to the SSP applications.	The RPC is attempting to perform a DR operation on a board number that is not in the range of valid numbers. The DR applications carefully filter the user input of catch out-of-range board numbers before they send the RPC. Therefore, this error indicates a breakdown on the SSP or in the network connection to the SSP. Or, it indicates an incompatibility between the SSP applications and the DR daemon.	Check the SSP network connection and/or the SSP and DR applications to ensure that they are operating properly.

**TABLE A-1** Protocol and Communication Failure Error Messages (Continued)

<b>Error Message</b>	<b>Probable Cause</b>	<b>Suggested Action</b>
<p>DR Error: <code>get_board_state: invalid board number</code></p> <p>This error message is sent to the system logs and to the SSP applications.</p>	<p>The RPC is attempting to perform a DR operation on a board number that is not in the range of valid numbers. The DR applications carefully filter the user input to catch out-of-range board numbers before they send the RPC. Therefore, this error indicates a breakdown on the SSP or in the network connection to the SSP. Or, it indicates an incompatibility between the SSP applications and the DR daemon.</p>	<p>Check the SSP network connection and/or the SSP and DR applications to ensure that they are operating properly.</p>
<p>DR Error: <code>get_cpu_info: invalid board number</code></p> <p>This error message is sent to the system logs and to the SSP applications.</p>	<p>The RPC is attempting to perform a DR operation on a board number that is not in the range of valid numbers. The DR applications carefully filter the user input to catch out-of-range board numbers before they send the RPC. Therefore, this error indicates a breakdown on the SSP or in the network connection to the SSP. Or, it indicates an incompatibility between the SSP applications and the DR daemon.</p>	<p>Check the SSP network connection and/or the SSP and DR applications to ensure that they are operating properly.</p>
<p>DR Error: <code>get_obp_board_config: invalid board number</code></p> <p>This error message is sent to the system logs and to the SSP applications.</p>	<p>The RPC is attempting to perform a DR operation on a board number that is not in the range of valid numbers. The DR applications carefully filter the user input to catch out-of-range board numbers before they send the RPC. Therefore, this error indicates a breakdown on the SSP or in the network connection to the SSP. Or, it indicates an incompatibility between the SSP applications and the DR daemon.</p>	<p>Check the SSP network connection and/or the SSP and DR applications to ensure that they are operating properly.</p>

**TABLE A-1** Protocol and Communication Failure Error Messages (Continued)

Error Message	Probable Cause	Suggested Action
<p>DR Error: initiate_attach_board: invalid board number</p> <p>This error message is sent to the system logs and to the SSP applications.</p>	<p>The RPC is attempting to perform a DR operation on a board number that is not in the range of valid numbers. The DR applications carefully filter the user input to catch out-of-range board numbers before they send the RPC. Therefore, this error indicates a breakdown on the SSP or in the network connection to the SSP. Or, it indicates an incompatibility between the SSP applications and the DR daemon.</p>	<p>Check the SSP network connection and/or the SSP and DR applications to ensure that they are operating properly.</p>
<p>DR Error: initiate_attach_board: invalid cpu number</p> <p>This error message is sent to the system logs and to the SSP applications.</p>	<p>The RPC is attempting to perform a initiate an attach of a board that contains a CPU that is not on the board. The DR applications carefully filter the user input of catch invalid CPU numbers before they send the RPC. Therefore, this error indicates a breakdown on the SSP or in the network connection to the SSP. Or, it indicates an incompatibility between the SSP applications and the DR daemon.</p>	<p>Check the SSP network connection and/or the SSP and DR applications to ensure that they are operating properly.</p>
<p>DR Error: Unauthorized RPC call . . . Not owner</p> <p>This error message is sent to the system logs and to the SSP applications.</p>	<p>The DR daemon received an RPC that failed authentication.</p>	<p>Check the system log for more information about this error. Also, make sure that the version numbers match for the SSP and the DR daemon and that the SSP user and network services are properly configured.</p>

---

# Attach-Related Failures

The following table contains attach-related failure errors that are sent to the system logs and/or the SSP applications.

**TABLE A-2** Attach-Related Failure Error Messages

Error Message	Probable Cause	Suggested Action
DR Error: abort_attach_board: invalid board state	The attach operation could not be aborted because the board is not in the init-attach state, awaiting to be configured into the domain.	Wait for the board to enter the init-attach state. Only then can the attach operation be aborted.
DR Error: attach_finished: invalid board state	Communication protocol has been breached over the state of the attach operation. The DR driver and daemon disagree with the SSP that the board was waiting for the confirmation of the attach operation from the SSP.	Exit and restart the current DR application, then retry the operation. If this error persists, stop and restart the DR daemon. You may need to reboot the domain to recover from this error.
DR Error: Cannot abort attach. Board ineligible for further DR operations.	The board entered the FATAL state after the abort command was issued, causing the abort operation to fail and the board to be lost from the system.	Reboot the domain.
dr_attach: failure executing A3000 hot_add script . . . <i>error message</i>	The Sun™ StoreEdge™ A3000 hot_add script is executed directly after a DR attach operation. If the script exists, but it cannot be executed, the error message explains why.	If you are not using, nor plan to use, A3000 devices, you can rename the script so that it will not be found.
initiate_attach_board: already init-attached	You attempted to initiate the attach of a board that was already initiated.	Go to the complete attach window and continue the attach process.
DR Error: complete_attach_board: invalid board state	You tried to initiate an attach operation on a board that is not eligible—the board is not in the Init-attach state awaiting attachment to the domain.	Wait for the board to enter the init-attach state. Only then can the attach operation be aborted.
DR Error: initiate_attach_board: invalid board state	You tried to initiate an attach operation on a board that is not eligible—the board is not in the PRESENT state awaiting attachment to the domain.	Wait for the board to enter the init-attach state. Only then can the attach operation be aborted.

**TABLE A-2** Attach-Related Failure Error Messages (Continued)

Error Message	Probable Cause	Suggested Action
DR Error: Some devices not attached. Examine the host syslog for details . . . <i>errno_description</i>	Some of the devices were not configured into the domain.	Look at the system logs for more details about what devices were not configured into the domain and why they were not configured. Some devices on the board may not be supported by the operating environment or by the DR feature. You should blacklist unsupported devices.

## Detach-Related Error Messages

The following table contains detach-related error messages that are sent to the system logs and/or to the SSP applications.

**TABLE A-3** Detach-Related Failure Error Messages

Error Message	Probable Cause	Suggested Action
DR Error: Cannot detach board <i>board_number</i> . It has <i>interface_name</i> interfaces configured.	The board is not eligible to be detached because it has one or more network interfaces attached to it that are critical to the operation of the domain. The network interfaces can be any mix of primary, SSP, AP, or PBF interfaces.	Use the <code>ifconfig(1M)</code> command to determine the role of the interface(s). If the configured interface is the primary network or the SSP, manually switch the interface to the alternate interface if one exists. For an interface other than the primary and the SSP, unplugging it may enable the detach operation to succeed. Otherwise, the domain must be shut down, and the interfaces must be moved to another board.
DR Error: cpu0_move_finished: invalid board state	Communication protocol has been breached over the eligibility of a CPU. To the SSP, the CPU has been moved off of the board. To the DR driver, the move operation is an invalid operation for that board.	None

**TABLE A-3** Detach-Related Failure Error Messages (*Continued*)

Error Message	Probable Cause	Suggested Action
ifconfig down failed.	The ifconfig(1M) command failed to bring down the network interfaces. The ifconfig(1M) command unplumbs and brings down the network interfaces before the board is detached. One of the network interfaces on the board could be busy, so manual intervention may be needed.	Log in to the domain, and, if possible, bring down the network interfaces on the board manually by using the ifconfig(1M) command with the down option. The manual execution of the command may yield more detailed information about the failure.
ifconfig unplumb failed.	The ifconfig(1M) command failed to unplumb the network interfaces. The ifconfig(1M) command unplumbs and brings down the network interfaces before the board is detached. One of the network interfaces on the board could be busy, so manual intervention may be needed.	Log in to the domain, and, if possible, unplumb the network interfaces manually by using the ifconfig(1M) command with the unplumb option. The manual execution of the command may yield more detailed information about the failure.
Warning: Error return from /opt/SUNWconn/bin/nf_snmd_kill ( <i>return_value</i> )	The command failed. Certain daemons keep network interfaces open continuously. Those daemons must be stopped before the devices they control can be detached.	Analyze the <i>return_value</i> to determine why the kill(1) command failed, and try to correct the problem. If necessary, use the ps(1) command to obtain the PID number for the daemons, and use the kill(1) command to stop the daemons manually.
Warning: Error return from /opt/SUNWconn/bin/pf_snmd_kill ( <i>return_value</i> )	The kill(1) command failed. The daemons that are used to control certain network devices must be stopped before the devices can be detached because the daemons keep the interfaces open continually.	Analyze the <i>return_value</i> to determine why the kill command failed, and try to correct the problem. If necessary, use the ps(1) command to obtain the PID number for the daemons, and use the kill(1) command to stop the daemons manually.
DR Error: abort_detach: board already drained	The CANCEL ioctl() failed while the DR daemon was trying to abort the detach operation. The failure caused the board to be reported as being in the UNREFERENCED state, indicating that the memory has already been drained.	The board must be completely detached before you can recover from this error. Retry the DR operation after the board has been successfully detached.



**TABLE A-3** Detach-Related Failure Error Messages (Continued)

<b>Error Message</b>	<b>Probable Cause</b>	<b>Suggested Action</b>
DR Error: abort_detach_board: invalid board state	Communication protocol has been breached over the eligibility of a board. To the SSP, the board is part of the domain and has been, or is being, drained of its resources. The SSP, therefore, issues the abort command to stop the detach operation. However, to the DR driver and daemon, the board is not part of the domain.	Exit and restart the DR application.
DR Error: board configuration query failed.	The DR daemon failed to ascertain the eligibility of the configuration of the board.	Stop and start the DR daemon and/or the DR driver. If this error persists, use the <code>modinfo(?)</code> , <code>modload(1M)</code> , and <code>modunload(1M)</code> commands to work with the driver after you have stopped the DR daemon. Also, check the size of the DR daemon with the <code>ps(1)</code> command. If it is not between 300- and 400 Kbytes, report this error, providing as much information from the system logs as possible.
DR Error: Cannot abort detach. Board detached from OS (detach completed).	This message indicates that the detach operation has completed. It follows the message that is displayed for the DR Error: <code>abort_detach: board already drained error message.</code>	See the DR Error: <code>abort_detach: board already drained message.</code>

**TABLE A-3** Detach-Related Failure Error Messages (*Continued*)

Error Message	Probable Cause	Suggested Action
DR Error: couldn't query cpu configuration	The complete-detach operation has failed because the DR daemon could not ascertain the CPU configuration just prior to the beginning of the complete-detach operation. After a board is detached, the DR daemon uses the information about the CPU configuration to update the <code>utmp</code> and <code>wtmp</code> entries for each CPU on the board. Although the complete-attach operation does not depend on the updates, if the mechanisms through which the CPU configuration is queried are broken, serious problems exist, so a completion of the detach operation should not proceed.	Stop and start the DR daemon and/or the DR driver. Also, check the size of the DR daemon with the <code>ps(1)</code> command. If it is not between 300- and 400-Kbytes, report this error, providing as much information from the system logs as possible.
DR Error: detach_board: invalid board state	Communication protocol has been breached over the eligibility of a board. To the SSP, the board is part of the domain, and its resources have been drained, causing the SSP to attempt to complete the detach operation. However, to the DR driver and daemon, the board is not part of the domain.	Examine the state of the board by using the <code>dr_cmd_board_states(?)</code> command, and determine the cause of the problem. Retry the drain and/or complete-detach operations to determine if the error is recoverable. Stop and start the DR daemon and driver.
DR Error: detach_board: invalid board state	The proper sequence of board states has not been followed, meaning that the board went into the error state or that an earlier failure in the drain-detach sequence of events was not properly reported.	Examine the state of the board by using the <code>dr_cmd_board_states(?)</code> command, and determine the cause of the problem. Retry the drain and/or complete-detach operations to determine if the error is recoverable. Stop and start the DR daemon and driver.

**TABLE A-3** Detach-Related Failure Error Messages (*Continued*)

Error Message	Probable Cause	Suggested Action
DR Error: detach_finished: invalid board state	Communication protocol has been breached over the eligibility of a board. To the SSP, the board has been detached. However, to the DR driver and daemon, the board has not been detached from the domain.	Examine the state of the board by using the <code>dr_cmd_board_states(?)</code> command, and determine the cause of the problem. Retry the drain and/or complete-detach operations to determine if the error is recoverable. Stop and start the DR daemon and driver.
DR Error: detachable_board: invalid board state	Communication protocol has been breached over the eligibility of a board. To the SSP, the board is part of the domain, so the SSP attempts to drain the resources. However, to the DR driver and daemon, the board is not part of the domain.	Examine the state of the board by using the <code>dr_cmd_board_states(?)</code> command, and determine the cause of the problem. Retry the drain and/or complete-detach operations to determine if the error is recoverable. Stop and start the DR daemon and driver.
DR Error: detaching board would leave no online CPUs	The detach operation failed because no CPUs would be left online after the board is detached.	Bring more CPUs online on other boards in the domain, or add more boards with online CPUs to the domain, so that the domain will have enough online CPUs after the board is detached.
DR Error: drain_board_resources: invalid board state	Communication protocol has been breached over the eligibility of a board. To the SSP, the board is part of the domain, so the SSP attempts to drain the resources. However, to the DR driver and daemon, the board is not part of the domain.	Examine the state of the board by using the <code>dr_cmd_board_states(?)</code> command, and determine the cause of the problem. Retry the drain and/or complete-detach operations to determine if the error is recoverable. Stop and start the DR daemon and driver.
DR Error: Remaining system memory ( <i>memory_size</i> mb) below minimum threshold ( <i>minimum_memory_size</i> mb) . . . .Not enough space	The domain must have enough memory to accommodate the memory of the board that is being detached. The detach operation failed because the domain does not have enough memory to detach the board.	Attach as many boards as necessary so that the memory in the domain will hold the memory on the board being detached.

**TABLE A-3** Detach-Related Failure Error Messages (*Continued*)

Error Message	Probable Cause	Suggested Action
DR Error: Some devices not re-attached. Examine the host syslog for details . . . . <i>errno_description</i>	Devices could not be reattached to the operating environment during an abort detach operation. Errors were encountered while the DR daemon tried to communicate with the device drivers for one or more devices on the board.	Examine the system logs to determine which devices were not reattached. If possible, fix the problem then issue the <code>complete_attach(1M)</code> command again to fully configure the board. If this action fails, the failure may be caused by an unsupported device for which a state cannot be resolved until the domain is rebooted.
DR Error: <code>sysconf</code> failed ( <code>_SC_NPROCESSORS_ONLN</code> ) . . . . <i>errno_description</i>	The <code>sysconf(3c)</code> system call failed to return the total number of online CPUs in the domain. Thus, the DR daemon cannot determine if the domain would be left with any online CPUs after the board is detached.	See the <code>sysconf(3c)</code> man page for more details about this error. Use those details and the <i>errno_description</i> to diagnose and solve the error. Retry the DR operation after you have solved the error. If no fix is apparent, stop and restart the DR daemon, then retry the DR operation.

## Auto-Configuration Error Messages

The following table contains the list of auto-configuration error messages that are sent to the system logs and/or to the SSP applications.

**TABLE A-4** Auto-Configuration Error Messages

Error Message	Probable Cause	Suggested Action
DR Error: Complete pending DR operation prior to running <code>autoconfig</code> . . . Invalid argument	The <code>autoconfig(1M)</code> command failed because a DR operation was still pending (that is, the board was not fully detached or attached before you issued the <code>autoconfig(1M)</code> command to reconfigure the operating environment).	Use the <code>dr_cmd_board_states(1M)</code> command to determine the state of the board. Decide to abort or complete the pending operation before you try to use the <code>autoconfig(1M)</code> command to reconfigure the operating environment.

**TABLE A-4** Auto-Configuration Error Messages (*Continued*)

<b>Error Message</b>	<b>Probable Cause</b>	<b>Suggested Action</b>
DR Error: Could not get /tmp/AddrEm.lck lock . . . <i>errno_description</i>	The DR daemon failed to get the lock it needs so that it can reconfigure the operating environment.	Check the additional <i>errno_description</i> and/or error number that is sent with the error message to determine why the lock could not be acquired.
DR Error: Could not unlock /tmp/AddrEm.lck lock . . . <i>errno_description</i>	The DR daemon could not release the lock.	Check the additional <i>errno_description</i> and/or error number that is sent with the error message to determine why the lock was not released.
DR Error: devlinks cmd failed. . . <i>error descriptions</i>	The devlinks(1M) command failed to reconfigure the operating environment.	Check the additional <i>error descriptions</i> and/or error number that is sent with the error message to determine why the command failed. Manually run the command on the domain.
DR Error: disks cmd failed . . . <i>error descriptions</i>	The disks(1M) command failed to reconfigure the operating environment.	Check the additional <i>error descriptions</i> and/or error number that is sent with the error message to determine why the command failed. Manually run the command on the domain.
DR Error: drvconfig cmd failed. . . <i>error description</i>	The drvconfig(1M) command failed to reconfigure the operating environment.	Check the additional <i>error description</i> and/or error number that is sent with the error message to determine why the command failed. Manually run the command on the domain.
DR Error: ports cmd failed . . . <i>error description</i>	The ports(1M) command failed to reconfigure the operating environment.	Check the additional <i>error description</i> and/or error number that is sent with the error message to determine why the command failed. Manually run the command on the domain.

**TABLE A-4** Auto-Configuration Error Messages (*Continued*)

<b>Error Message</b>	<b>Probable Cause</b>	<b>Suggested Action</b>
DR Error: sync cmd failed . . . <i>error description</i>	The sync(1M) command failed to reconfigure the operating environment.	Check the additional <i>error description</i> and/or error number that is sent with the error message to determine why the command failed. Manually run the command on the domain.
DR Error: tapes cmd failed . . . <i>error descriptions</i>	The tapes(1M) command failed to reconfigure the operating environment.	Check the additional <i>error description</i> and/or error number that is sent with the error message to determine why the command failed. Manually run the command on the domain.

# Index

---

## A

- abort button, 9, 19
- active DR operations, only one, 2
- amount of memory attachable, 30
- attach, 1
- attach buttons, 9
- attach, complete, 12
- attach, dynamic reconfiguration window, 11
- attach, parameter selection, 10
- attachable memory, 30
- attaching with dr(1M), 13

## B

- board attach, 1
- board detach, 1, 16
- board, attach, 10
- buttons
  - abort, 9, 19
  - complete, 9, 12, 18, 22
  - CPU, 27
  - device, 31
  - dismiss, 9, 19
  - drain, 18, 21
  - force, 18
  - help, 9, 19
  - init attach, 9, 11
  - reconfig, 9, 18
  - select, 10

## C

- CEs (correctable memory errors) and detach, 3
- communication timeouts affecting Hostview and dr(1M), 5
- complete attach, 8, 12
- complete attach vi dr(1M), 15
- complete button, 9, 12, 18, 22
- complete detach, 17, 22
- complete detach via dr(1M), 25
- connection, loss of, 5
- copying nonpageable memory before detach
  - detach
    - copying nonpageable memory before detach, 2
- correctable memory errors (CEs) and detach, 3
- CPU button, 27
- CPU configuration window, 27

## D

- detach, 1, 16
  - configuring memory for detach, 2
  - correctable memory errors (CEs) and detach, 3
  - interleaved memory and detach, 2
  - nonpageable memory, determining if present, 3
- detach buttons, 18
- detach, parameter selection window, 20
- detaching with dr(1M), 22
- detaching with Hostview, 19
- device button, 31

- device configuration window, 31
- device detail window, 32
- dismiss button, 9, 19
- DR attach, 1
- DR detach, 1, 16
- DR overview, 1
- DR parameter selection, 10
- DR unsafe devices, 35
- dr(1M), attaching via, 13
- drain, 16
- drain button, 21
- drain via dr(1M), 24
- drain, percent complete, 31
- draining button, 18
- dr-max-mem environment variable, 30
- drshow example, 3
- drshow, dr(1M) command, 15
- dynamic reconfiguraiton window, detach, 21
- dynamic reconfiguration window, attach, 11

## E

- environment variables
  - dr-max-mem, 30

## F

- files
  - .postrc, and memory interleaving, 2
- force button, 18

## H

- help button, 9, 19
- Hostview, detaching via, 19

## I

- init attach, 8, 11
- init attach button, 9, 11
- init attach, with dr(1M), 14
- interleaved memory and detach, 2

- interleaved memory, determining if enabled, 2

## L

- loss of connection, 5

## M

- memory attach capacity, 30
- memory button
  - buttons
    - memory, 29
- memory configuration window, 29
- Memory Configuration window (Hostview), and nonpageable memory, 3
- memory draining, detach, 16
- memory interleaving, determining if enabled, 2
- memory reduction, detach, 30
- memory remaining in system, 30
- memory, configuring for detach, 2
- memory, determining if nonpageable memory is present, 3
- memory, pageable and nonpageable, 2
- memory, total size (all boards), 30

## N

- nonpageable and pageable memory, 2
- nonpageable memory and Memory Configuration window (Hostview), 3
- nonpageable memory, copying before detach, 2
- nonpageable memory, determining if present, 3
- nonpageable memory, target board for copying, 3

## O

- overview of DR, 1

## P

- pageable and nonpageable memory, 2
- parameter selection window, detach, 20



parameter selection, attach, 10  
percent complete, drain, 31

## Q

quiesce OS during detach, and nonpageable  
memory, 2

## R

reconfig button, 9, 18  
record-stop dumps and detach, 4  
reduction of memorym detacg, 30  
remaining memory, detach, 30  
RPC timeout, 5

## S

select button, 10  
SSP messages file, 2  
suspending OS during detach, and nonpageable  
memory, 2  
system board, target for copying nonpageable  
memory, 3  
system information, viewing, 25

## T

target board for nonpageable memory copy, 3  
target domain, attach, 10  
timeout, RPC, 5  
timeouts affecting Hostview and dr(1M), 5

## U

unsafe devices, 35  
unsafe devices window, 35

## V

viewing system information, 25

## W

### windows

CPU configuration, 27  
detach parameter selection, 20  
device configuration, 31  
device detail, 32  
DR parameter selection, 10  
dynamic reconfiguration, 11  
memory configuration, 29  
  
unsafe devices, 35

