

Sun Enterprise™ 10000 SSP

3.2 User Guide



THE NETWORK IS THE COMPUTER™

Sun Microsystems, Inc.
901 San Antonio Road
Palo Alto, CA 94303-4900 USA
650 960-1300 Fax 650 969-9131

Part No.: 806-1500-10
Revision A, November 1999

Send comments about this document to: docfeedback@sun.com

Copyright 1999 Sun Microsystems, Inc., 901 San Antonio Road, Palo Alto, California 94303-4900 U.S.A. All rights reserved.

This product or document is protected by copyright and distributed under licenses restricting its use, copying, distribution, and decompilation. No part of this product or document may be reproduced in any form by any means without prior written authorization of Sun and its licensors, if any. Third-party software, including font technology, is copyrighted and licensed from Sun suppliers.

Parts of the product may be derived from Berkeley BSD systems, licensed from the University of California. UNIX is a registered trademark in the U.S. and other countries, exclusively licensed through X/Open Company, Ltd. For Netscape Communicator™, the following notice applies: (c) Copyright 1995 Netscape Communications Corporation. All rights reserved.

Sun, Sun Microsystems, the Sun logo, OpenBoot, OpenWindows, AnswerBook2, docs.sun.com, and Solaris are trademarks, registered trademarks, or service marks of Sun Microsystems, Inc. in the U.S. and other countries. All SPARC trademarks are used under license and are trademarks or registered trademarks of SPARC International, Inc. in the U.S. and other countries. Products bearing SPARC trademarks are based upon an architecture developed by Sun Microsystems, Inc.

The OPEN LOOK and Sun™ Graphical User Interface was developed by Sun Microsystems, Inc. for its users and licensees. Sun acknowledges the pioneering efforts of Xerox in researching and developing the concept of visual or graphical user interfaces for the computer industry. Sun holds a non-exclusive license from Xerox to the Xerox Graphical User Interface, which license also covers Sun's licensees who implement OPEN LOOK GUIs and otherwise comply with Sun's written license agreements.

RESTRICTED RIGHTS: Use, duplication, or disclosure by the U.S. Government is subject to restrictions of FAR 52.227-14(g)(2)(6/87) and FAR 52.227-19(6/87), or DFAR 252.227-7015(b)(6/95) and DFAR 227.7202-3(a).

DOCUMENTATION IS PROVIDED "AS IS" AND ALL EXPRESS OR IMPLIED CONDITIONS, REPRESENTATIONS AND WARRANTIES, INCLUDING ANY IMPLIED WARRANTY OF MERCHANTABILITY, FITNESS FOR A PARTICULAR PURPOSE OR NON-INFRINGEMENT, ARE DISCLAIMED, EXCEPT TO THE EXTENT THAT SUCH DISCLAIMERS ARE HELD TO BE LEGALLY INVALID.

Copyright 1999 Sun Microsystems, Inc., 901 San Antonio Road, Palo Alto, Californie 94303-4900 U.S.A. Tous droits réservés.

Ce produit ou document est protégé par un copyright et distribué avec des licences qui en restreignent l'utilisation, la copie, la distribution, et la décompilation. Aucune partie de ce produit ou document ne peut être reproduite sous aucune forme, par quelque moyen que ce soit, sans l'autorisation préalable et écrite de Sun et de ses bailleurs de licence, s'il y en a. Le logiciel détenu par des tiers, et qui comprend la technologie relative aux polices de caractères, est protégé par un copyright et licencié par des fournisseurs de Sun.

Des parties de ce produit pourront être dérivées des systèmes Berkeley BSD licenciés par l'Université de Californie. UNIX est une marque déposée aux Etats-Unis et dans d'autres pays et licenciée exclusivement par X/Open Company, Ltd. La notice suivante est applicable à Netscape Communicator™ : (c) Copyright 1995 Netscape Communications Corporation. All rights reserved.

Sun, Sun Microsystems, le logo Sun, OpenBoot, OpenWindows, AnswerBook2, docs.sun.com, et Solaris sont des marques de fabrique ou des marques déposées, ou marques de service, de Sun Microsystems, Inc. aux Etats-Unis et dans d'autres pays. Toutes les marques SPARC sont utilisées sous licence et sont des marques de fabrique ou des marques déposées de SPARC International, Inc. aux Etats-Unis et dans d'autres pays. Les produits portant les marques SPARC sont basés sur une architecture développée par Sun Microsystems, Inc.

L'interface d'utilisation graphique OPEN LOOK et Sun™ a été développée par Sun Microsystems, Inc. pour ses utilisateurs et licenciés. Sun reconnaît les efforts de pionniers de Xerox pour la recherche et le développement du concept des interfaces d'utilisation visuelle ou graphique pour l'industrie de l'informatique. Sun détient une licence non exclusive de Xerox sur l'interface d'utilisation graphique Xerox, cette licence couvrant également les licenciés de Sun qui mettent en place l'interface d'utilisation graphique OPEN LOOK et qui en outre se conforment aux licences écrites de Sun.

CETTE PUBLICATION EST FOURNIE "EN L'ETAT" ET AUCUNE GARANTIE, EXPRESSE OU IMPLICITE, N'EST ACCORDEE, Y COMPRIS DES GARANTIES CONCERNANT LA VALEUR MARCHANDE, L'APTITUDE DE LA PUBLICATION A REpondre A UNE UTILISATION PARTICULIERE, OU LE FAIT QU'ELLE NE SOIT PAS CONTREFAISANTE DE PRODUIT DE TIERS. CE DENI DE GARANTIE NE S'APPLIQUERAIT PAS, DANS LA MESURE OU IL SERAIT TENU JURIDIQUEMENT NUL ET NON AVENU.



Adobe PostScript

Sun Enterprise 10000 SSP Attributions:

This software is copyrighted by the Regents of the University of California, Sun Microsystems, Inc., and other parties. The following terms apply to all files associated with the software unless explicitly disclaimed in individual files.

The authors hereby grant permission to use, copy, modify, distribute, and license this software and its documentation for any purpose, provided that existing copyright notices are retained in all copies and that this notice is included verbatim in any distributions. No written agreement, license, or royalty fee is required for any of the authorized uses. Modifications to this software may be copyrighted by their authors and need not follow the licensing terms described here, provided that the new terms are clearly indicated on the first page of each file where they apply.

IN NO EVENT SHALL THE AUTHORS OR DISTRIBUTORS BE LIABLE TO ANY PARTY FOR DIRECT, INDIRECT, SPECIAL, INCIDENTAL, OR CONSEQUENTIAL DAMAGES ARISING OUT OF THE USE OF THIS SOFTWARE, ITS DOCUMENTATION, OR ANY DERIVATIVES THEREOF, EVEN IF THE AUTHORS HAVE BEEN ADVISED OF THE POSSIBILITY OF SUCH DAMAGE.

THE AUTHORS AND DISTRIBUTORS SPECIFICALLY DISCLAIM ANY WARRANTIES, INCLUDING, BUT NOT LIMITED TO, THE IMPLIED WARRANTIES OF MERCHANTABILITY, FITNESS FOR A PARTICULAR PURPOSE, AND NON-INFRINGEMENT. THIS SOFTWARE IS PROVIDED ON AN "AS IS" BASIS, AND THE AUTHORS AND DISTRIBUTORS HAVE NO OBLIGATION TO PROVIDE MAINTENANCE, SUPPORT, UPDATES, ENHANCEMENTS, OR MODIFICATIONS.

RESTRICTED RIGHTS: Use, duplication or disclosure by the government is subject to the restrictions as set forth in subparagraph (c) (1) (ii) of the Rights in Technical Data and Computer Software Clause as DFARS 252.227-7013 and FAR 52.227-19.

This is scotty, a simple tcl interpreter with some special commands to get information about TCP/IP networks. Copyright (c) 1993, 1994, 1995, J. Schoenwaelder, TU Braunschweig, Germany, Institute for Operating Systems and Computer Networks. Permission to use, copy, modify, and distribute this software and its documentation for any purpose and without fee is hereby granted, provided that this copyright notice appears in all copies. The University of Braunschweig makes no representations about the suitability of this software for any purpose. It is provided "as is" without express or implied warranty.

Contents

1. Introduction to the SSP 1

SSP 3.2 Features 1

System Architecture 2

SSP User Environment 3

▼ To Begin Using the SSP 4

SSP 3.2 Window 4

▼ To Display an SSP Window Locally in the Common Desktop Environment (CDE) 5

▼ To Display an SSP Window Remotely 5

SSP Console Window 5

▼ To Display an SSP Console Window Locally with CDE 5

Network Console Window 6

Hostview 6

2. Hostview 9

▼ To Start Up Hostview From a Remote Login Session 10

▼ To Start Up Hostview From the Workspace Menu Locally on the SSP 10

▼ To Start Up Hostview Under CDE From the Front Panel 10

Hostview Main Window 11

Selecting Items in the Main Window 13

Main Window Menu Bar	14
Help Window	16
Main Window Buttons	18
Main Window Processor Symbols	19
Hostview Performance Considerations	20
SSP Log Files	21
▼ To View a messages File From Within Hostview	21

3. Domain Administration 23

Domain Configuration Requirements	23
▼ To Create Domains From Within Hostview	24
▼ To Create Domains From the Command Line	26
▼ To Recreate the <code>eeeprom.image</code> File	27
▼ To Remove Domains From Within Hostview	28
▼ To Remove Domains From the Command Line	30
▼ To Rename Domains From Within Hostview	30
▼ To Rename Domains From the Command Line	31
▼ To Bring Up a Domain From Within Hostview	32
▼ To Bring up a Domain From the Command Line	32
▼ To Obtain Domain Status From Within Hostview	33

4. `netcon` and `netcontool` 35

Using <code>netcon(1M)</code>	35
▼ To Start <code>netcon(1M)</code> From the Command Line	36
▼ To Start <code>netcon(1M)</code> From the CDE Front Panel	36
▼ To Start <code>netcon(1M)</code> From the CDE Workspace Menu	36
▼ To Exit From a <code>netcon(1M)</code> Window	37
Using <code>netcontool(1M)</code>	37
▼ To Display a <code>netcontool(1M)</code> Window From the Command Line	38

- ▼ To Display a netcontool(1M) Window From the CDE Front Panel 38
 - ▼ To Display a netcontool(1M) Window From the CDE Workspace Menu 39
 - ▼ To Display the netcontool(1M) Window From Hostview 39
 - ▼ To Configure the netcontool(1M) Window 40
 - netcon(1M) Communications 42
 - netcon(1M) Message Logging 43
 - ▼ To Enable netcon(1M) Logging 43
 - ▼ To Disable netcon(1M) Logging Sessions for Specific Hosts 43
 - ▼ To Re-Enable netcon(1M) Logging Sessions for Specific Hosts 44
- 5. Power Administration 45**
- ▼ To Power Components On or Off From Within Hostview 45
 - ▼ To Power System Boards On and Off From the Command Line 47
 - ▼ To Monitor Power Levels in Hostview 47
- 6. Thermal Conditions Administration 51**
- ▼ To Monitor Thermal Conditions From Within Hostview 51
 - ▼ To Monitor Fans From Within Hostview 53
 - ▼ To Control Fans From Within Hostview 55
- 7. Blacklist Administration 57**
- ▼ To Blacklist Components From Within Hostview 58
 - ▼ To Blacklist Processors From Within Hostview 59
 - ▼ To Clear the Blacklist File From Within Hostview 61
- 8. Using a Spare SSP 63**
- ▼ To Switch Between the Main and Spare SSP 64
- 9. Dual Control Board Handling 67**
- Control Board Executive 67

Primary Control Board 67

Control Board Server 68

Control Board Executive Image and Port Specification Files 69

▼ To Switch the Primary Control Board 69

10. SSP Internals 73

Startup Flow 73

Sun Enterprise 10000 Client/Server Architecture 74

POST 76

Daemons 77

Event Detector Daemon 78

Control Board Server 80

File Access Daemon 81

Network Time Protocol Daemon 81

OBP Daemon 82

Environment Variables 83

Executable Files Within a Domain 83

*.elf Files 83

download_helper File 84

obp File 84

Figures

FIGURE 1-1	Enterprise 10000 System and Control Boards	3
FIGURE 1-2	SSP Window	4
FIGURE 1-3	netcon(1M) Window	6
FIGURE 1-4	Hostview GUI Program	7
FIGURE 2-1	Hostview Main Window	11
FIGURE 2-2	UnSelected System Board (domain independent)	12
FIGURE 2-3	UnSelected System Board (domain dependent)	12
FIGURE 2-4	Selected System Board (domain dependent)	13
FIGURE 2-5	Hostview Help Window	17
FIGURE 2-6	Power Button	18
FIGURE 2-7	Temperature Button	18
FIGURE 2-8	Fan Button	18
FIGURE 2-9	Failure Button	19
FIGURE 2-10	SSP Logs Window	22
FIGURE 3-1	Create Domain Window	25
FIGURE 3-2	Remove Domain Window	29
FIGURE 3-3	Rename Domain Window	31
FIGURE 3-4	Domain Status Window	34
FIGURE 4-1	netcontool GUI Program	37

FIGURE 4-2	netcontool Window in Hostview	39
FIGURE 4-3	netcontool Console Configuration Window	40
FIGURE 5-1	Power Control and Status Window	46
FIGURE 5-2	Power Button	48
FIGURE 5-3	Power Status Display	48
FIGURE 5-4	System Board Power Detail Window	49
FIGURE 6-1	Temperature Button	51
FIGURE 6-2	Thermal Status Display	52
FIGURE 6-3	System Board Thermal Detail	53
FIGURE 6-4	Fan Button	53
FIGURE 6-5	Fan Status Display	54
FIGURE 6-6	Fan Tray Window	55
FIGURE 6-7	Fan Control and Status Window	56
FIGURE 7-1	Blacklist Edit Window—Board View	58
FIGURE 7-2	Blacklist Edit Window—Processor View	60
FIGURE 10-1	Sun Enterprise 10000 Client/Server Architecture	75
FIGURE 10-2	Uploading Event Detection Scripts	78
FIGURE 10-3	Event Recognition and Delivery	79
FIGURE 10-4	Response Action	79
FIGURE 10-5	CBS Communication Between SSP and Sun Enterprise 10000 System	80

Preface

The *Sun Enterprise™ 10000 SSP 3.2 User Guide* describes the System Service Processor (SSP), which enables you to monitor and control the Sun Enterprise™ 10000 system.

How This Book Is Organized

This document contains the following chapters:

Chapter 1 introduces the System Service Processor (SSP).

Chapter 2 describes the Hostview Graphical User Interface (GUI).

Chapter 3 describes how to create, remove, rename, and bring up domains and also describes how to get status information on a domain.

Chapter 4 describes how to use `netcon(1M)` and `netcontool(1M)`.

Chapter 5 describes how to control the system's power resources from within Hostview or from the command line, to control the peripherals power resources from the command line, and to monitor the power levels in Hostview.

Chapter 6 describes how to administer the thermal conditions and fans from within Hostview and how to monitor and control the fans from within Hostview.

Chapter 7 describes how to configure components out of the system using the blacklist file.

Chapter 8 describes the procedure for switching between the main and spare SSP.

Chapter 9 provides information on the use of two control boards.

Chapter 10 provides more detailed information for system administrators interested in how the SSP works. Included are descriptions of the SSP booting process and the `edd(1M)` daemon that monitors the Sun Enterprise 10000 system.

Before You Read This Book

This manual is intended for Sun Enterprise 10000 system administrators who have a working knowledge of UNIX® systems, particularly those based on the Solaris™ operating environment. If you do not have such knowledge, you should first read the Solaris User and System Administrator AnswerBook2™ provided with this system, and consider UNIX system administration training.

Using UNIX Commands

This document does not contain information on basic UNIX commands and procedures such as shutting down the system, booting the system, and configuring devices.

See one or more of the following for this information:

- AnswerBook2 online documentation for the Solaris software environment, particularly those dealing with Solaris system administration
- Other software documentation that you received with your system

Typographic Conventions

TABLE P-1 Typographic Conventions

Typeface or Symbol	Meaning	Examples
AaBbCc123	The names of commands, files, and directories; on-screen computer output.	Edit your <code>.login</code> file. Use <code>ls -a</code> to list all files. % You have mail.
AaBbCc123	What you type, when contrasted with on-screen computer output.	% su Password:
<i>AaBbCc123</i>	Book titles, new words or terms, words to be emphasized. Command-line variable; replace with a real name or value.	Read Chapter 6 in the <i>User's Guide</i> . These are called <i>class</i> options. You <i>must</i> be <code>root</code> to do this. To delete a file, type <code>rm filename</code> .

Shell Prompts

TABLE P-2 Shell Prompts

Shell	Prompt
C shell	<i>machine_name%</i>
C shell superuser	<i>machine_name#</i>
Bourne shell and Korn shell	\$
Bourne shell and Korn shell superuser	#

SSP Command Syntax

SSP commands ignore any unrecognized parameters used on the command line.

Related Documentation

TABLE P-3 Related Documentation

Application	Title	Part Number
Installation	<i>Sun Enterprise 10000 SSP 3.2 Installation Guide and Release Notes</i>	806-1502-10
Reference (man pages)	<i>Sun Enterprise 10000 SSP 3.2 Reference Manual</i>	806-1501-10
Release Notes	<i>Sun Enterprise 10000 SSP 3.2 Installation and Release Notes</i>	806-1502-10
Other	<i>Sun Enterprise 10000 Dynamic Reconfiguration User's Guide</i>	805-7985-10
	<i>Sun Enterprise 10000 Dynamic Reconfiguration Reference Manual</i>	805-7986-10
	<i>Sun Enterprise Server Alternate Pathing User's Guide</i>	805-5985-10
	<i>Sun Enterprise Server Alternate Pathing Reference Manual</i>	805-5986-10

Accessing Sun Documentation Online

The docs.sun.comSM web site enables you to access Sun technical documentation on the Web. You can browse the docs.sun.com archive or search for a specific book title or subject at:

<http://docs.sun.com>

Sun Welcomes Your Comments

We are interested in improving our documentation and welcome your comments and suggestions. You can email your comments to us at:

`docfeedback@sun.com`

Please include the part number (806-1500-10) of your document in the subject line of your email.

Introduction to the SSP

The System Service Processor (SSP) is a SPARC™ workstation or SPARC server that enables you to control and monitor the Sun Enterprise 10000 system. You can use a Sparcstation 5™, Sun Ultra 5™, or Sun Enterprise 250™ workstation or server as an SSP. In this book, the SSP workstation or server is simply called the *SSP*. The SSP 3.2 software packages must be installed on the SSP. In addition, the SSP must be able to communicate with the Sun Enterprise 10000 system over an Ethernet connection.

The Sun Enterprise 10000 system is often referred to as the *platform*. System boards within the platform may be logically grouped together into separately bootable systems called *Dynamic System Domains*, or simply *domains*. Up to 8 domains may exist simultaneously on a single platform. (Domains are introduced in this chapter, and are described in more detail in Chapter 3 “Domain Administration.”) The SSP enables you to control and monitor domains, as well as the platform itself.

Note – Do not run any third party software on the SSP. (If you are using clusters, you can run the Sun Cluster Console on the SSP. Clustering is beyond the scope of this manual.)

SSP 3.2 Features

SSP 3.2 software can be loaded only on Sun workstations or Sun servers running the Solaris 2.6 or Solaris 7 operating environment with the Common Desktop Environment (CDE). SSP 3.2 software is compatible with Sun Enterprise 10000 domains that are running the Solaris 2.5.1, 2.6, or 7 operating environments. The commands and GUI programs that are provided with the SSP 3.2 software can be used remotely.

The SSP enables the system administrator to perform the following tasks:

- Boot domains.
- Perform an emergency shutdown in an orderly fashion. For example, the SSP 3.2 software automatically shuts down a domain if the temperature of a processor within that domain rises above a preset level.
- Dynamically reconfigure a domain so that currently installed system boards can be *logically* attached to or detached from the operating system while the domain continues running in multiuser mode. This feature is known as *Sun Enterprise 10000 dynamic reconfiguration* and is described in the *Sun Enterprise 10000 Dynamic Reconfiguration User's Guide*. (A system board can easily be *physically* swapped in and out when it is not attached to a domain, even while the system continues running in multiuser mode.)
- Create domains by logically grouping system boards together. Domains are able to run their own operating system and handle their own workload. See Chapter 3 "Domain Administration".
- Assign paths to different controllers for I/O devices, which enables the system to continue running in the event of certain types of failures. This feature is known as *Alternate Pathing (AP)* and is described in the *Sun Enterprise 10000 Alternate Pathing 2.2 User's Guide*.
- Monitor and display the temperatures, currents, and voltage levels of one or more system boards or domains.
- Control fan operations.
- Monitor and control power to the components within a platform.
- Execute diagnostic programs such as power-on self-test (POST).

In addition, the SSP environment:

- Warns you of impending problems, such as high temperatures or malfunctioning power supplies.
- Notifies you when a software error or failure has occurred.
- Automatically reboots a domain after a system software failure (such as a panic).
- Keeps logs of interactions between the SSP environment and the domains.
- Provides support for Inter-Domain Networks (IDN)

System Architecture

The Sun Enterprise 10000 platform, the SSP, and other workstations communicate over Ethernet (FIGURE 1-1).

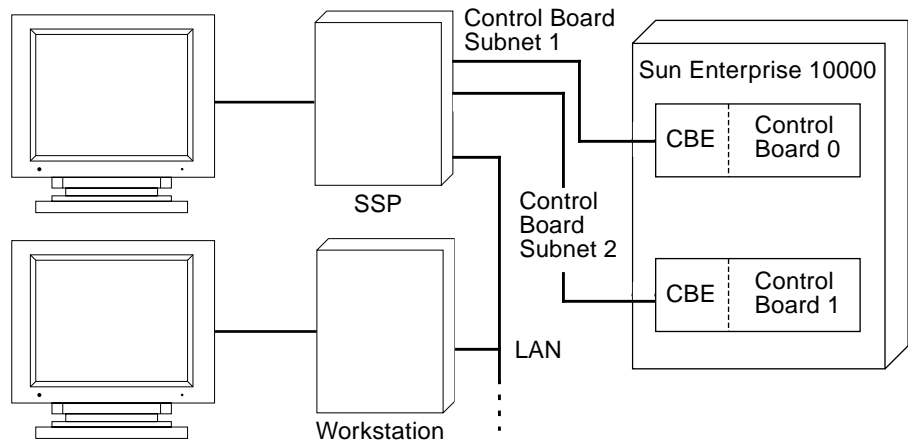

FIGURE 1-1 Enterprise 10000 System and Control Boards

Dual control boards are supported within the Sun Enterprise 10000 platform. Each control board runs a control board executive (CBE) that communicates with the SSP over a private network. One control board is designated as the primary control board, and the other is designated as the alternate control board. Only one control board is active at a time. If the primary control board fails, you can manually switch to the alternate control board as described in Chapter 9 “Dual Control Board Handling.”

SSP operations can be performed by entering commands on the SSP console or by remotely logging in to the SSP from another workstation on the local area network. Whether you log in to the SSP remotely or locally, you must log in as user `ssp` and provide the appropriate password if you want to perform SSP operations (such as monitoring and controlling the platform).

SSP User Environment

You can interact with the SSP and the domains on the Sun Enterprise 10000 by using SSP commands and the SSP GUI programs.

▼ To Begin Using the SSP

1. **Boot the SSP.**
2. **Log in to the SSP as user `ssp`.**
3. **Type:**

```
ssp% tail -f $SSPLOGGER/messages
```

4. **Wait until you see the following message:**

```
Startup of SSP programs complete
```

At this point you can begin using SSP programs such as Hostview and netcontool(1M).

SSP 3.2 Window

An SSP window provides a command line interface to the Solaris operating environment and SSP 3.2 environment (FIGURE 1-2).

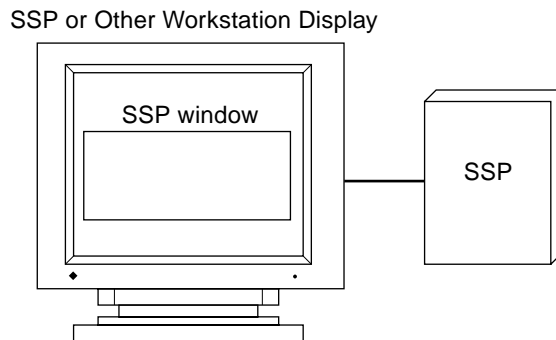

FIGURE 1-2 SSP Window

▼ To Display an SSP Window Locally in the Common Desktop Environment (CDE)

1. **Log in to the SSP as user `ssp`.**
2. **Open an SSP window using one of the following methods:**
 - From the CDE front panel under the Solaris 2.6 operating environment, select the Personal Applications sub-panel (which looks like a notepad), and then select Terminal.
 - From the CDE front panel under the Solaris 7 operating environment, select the Hosts sub-panel, and then select This Host.
 - From the Workspace Menu (right mouse click) choose Programs and then choose Terminal.

▼ To Display an SSP Window Remotely

1. **Use the `rlogin(1)` command to remotely log in to the SSP 3.2 machine as user `ssp`, and enter the `ssp` password.**
2. **When prompted, type in the name of the platform or domain with which you want to work, and then press Return.**

The `SUNW_HOSTNAME` environment variable is set to the value you enter.

SSP Console Window

The SSP console window is the console for the SSP workstation or server. The system uses it to log operating system messages.

▼ To Display an SSP Console Window Locally with CDE

1. **Log in to the SSP as user `ssp`.**
2. **Open an SSP window using one of the following methods:**
 - From the Workspace Menu (right mouse click) choose Programs and then choose Console. This method works under the Solaris 2.6 or Solaris 7 operating environment.

- From the CDE front panel under the Solaris 7 operating environment, select the Hosts sub-panel, and then select Console. This method works only under the Solaris 7 operating environment.

Network Console Window

The network console window, or `netcon(1M)` window, receives system console messages (operating system messages) from a domain (FIGURE 1-3).

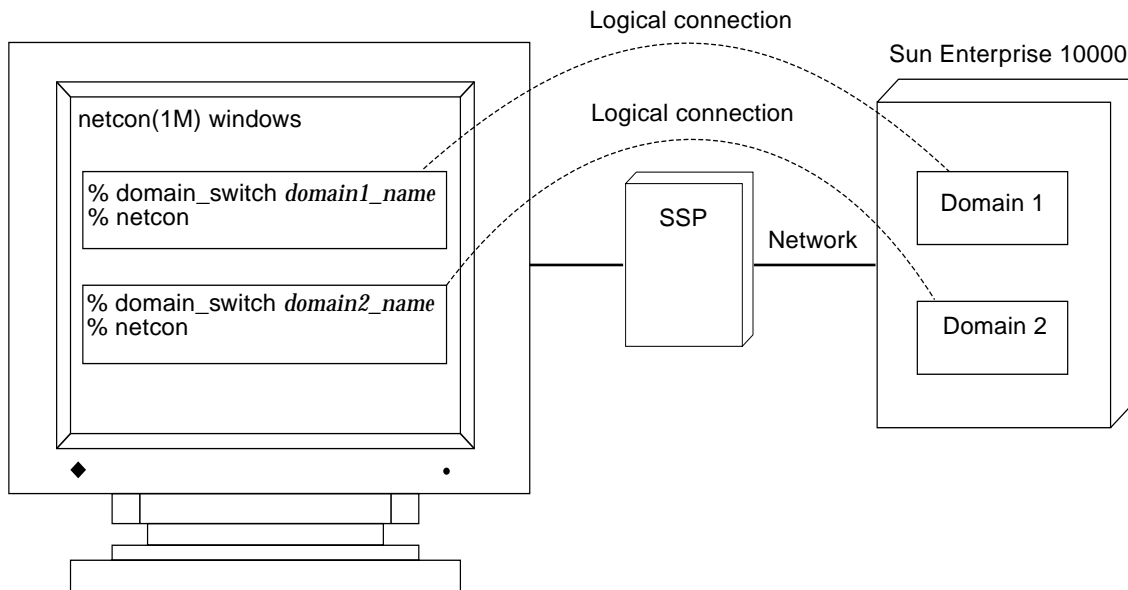

FIGURE 1-3 `netcon(1M)` Window

A `netcon(1M)` window behaves as if a workstation were physically connected to a domain. It also logs messages for operations such as dynamic reconfiguration of system boards. For more information, see “Using `netcon(1M)`” on page 35 and the `netcon(1M)` man page.

Hostview

The Hostview program provides a graphical user interface (GUI) with the same functionality as many of the SSP commands (FIGURE 1-4).

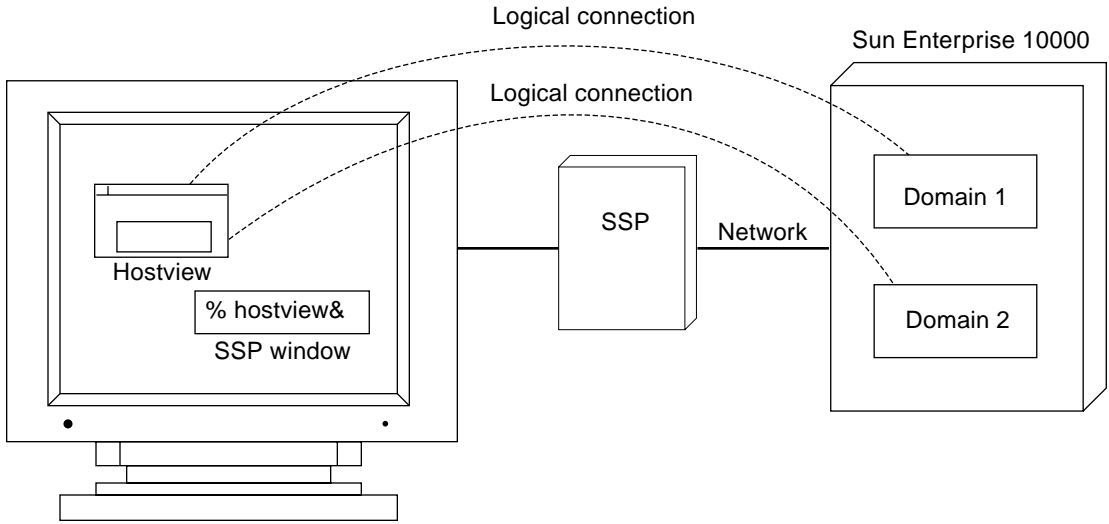

FIGURE 1-4 Hostview GUI Program

Hostview is described in detail in Chapter 2 “Hostview”. It is also described in the `hostview(1M)` man page in the *Sun Enterprise 10000 SSP 3.2 Reference Manual*.

Hostview

This chapter describes Hostview, the GUI front-end to SSP 3.2 commands.

Hostview enables you to perform administration operations such as:

- Dynamically grouping the system boards into domains. Each domain runs its own instance of the Solaris operating environment and has its own log messages file.
- Booting the Solaris operating environment for a domain.
- Accessing the SSP log messages file for each platform or domain.
- Remotely logging in to each domain.
- Displaying a `netcon(1M)` window for each domain.
- Editing the `blacklist(4)` file to enable or disable hardware components in a domain.
- Dynamically reconfiguring the boards within a platform, logically attaching or detaching them from the operating system. This feature is described in the *Sun Enterprise 10000 Dynamic Reconfiguration User's Guide*.
- Powering the system boards on and off.
- Monitoring the temperature and voltage levels of hardware components.

If you want to run Hostview, you only need to run one instance for a given platform. However, it is possible to run more than one instance simultaneously (perhaps on different workstations) to work with the same platform.

If you have logged into the SSP environment from a remote login session, make sure your `DISPLAY` environment variable is set to your current display and that your `xhost` settings enable the SSP to display on your workstation (see `xhost(1)` in the *Solaris X Window System Reference Manual*).

▼ To Start Up Hostview From a Remote Login Session

1. Enable external hosts to display on your local workstation:

```
% xhost +
```

2. Log in to the SSP as user `ssp` and type:

```
ssp% setenv DISPLAY machine_name:0.0  
ssp% hostview &
```

▼ To Start Up Hostview From the Workspace Menu Locally on the SSP

- From the Workspace Menu (right mouse button click), select SSP, and then select Hostview.

This is available only when you use the SSP workstation, not when you use a remote login session to the SSP.

▼ To Start Up Hostview Under CDE From the Front Panel

- Use one of the following methods:
 - Click the SSP icon on the front panel. The icon shows a hand holding tools.
 - Click the arrow above the SSP icon on the front panel, and select Hostview.
 - Log in as user `ssp`:

```
ssp% hostview &
```

Hostview Main Window

When you start Hostview, the main window is displayed (FIGURE 2-1).



FIGURE 2-1 Hostview Main Window

The menu bar on the main window provides the commands that you use to control the platform. The commands are described in “Main Window Menu Bar” on page 14.

The buttons on the main window (Power, Temperature, and Fans) bring up status details. The buttons are described in “Main Window Buttons” on page 18.

The rest of the main window provides a graphical view of the platform boards and buses. The system boards are named SB0 through SB15, and their processor numbers are shown. The control boards are named CB0 and CB1. The support boards are named CSB0 and CSB1. The buses are named ABUS0 through ABUS3, DBUS0, and DBUS1.

The system boards along the top of the display are arranged in the order they appear on the front side of the physical platform. The system boards along the bottom of the display are arranged in the order they appear on the back side of the physical platform.

If a system board is shown with no outline (FIGURE 2-2), the board is not part of a domain and is not currently selected.

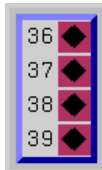

FIGURE 2-2 UnSelected System Board (domain independent)

If a system board is part of a domain (FIGURE 2-3), a colored outline surrounds it. The boards within a given domain all have outlines of the same color.

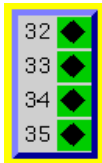

FIGURE 2-3 UnSelected System Board (domain dependent)

A black outline around the domain color outline indicates that a board is selected (FIGURE 2-4). (There are several reasons why you select a board in Hostview. For example, you could select one or more boards, and then create a domain that is based on those boards.)



FIGURE 2-4 Selected System Board (domain dependent)

The processors within the boards are numbered 0 through 63. The processor symbols (diamond, circle, and so forth) indicate the state of the processors and are described in “Main Window Processor Symbols” on page 19.

Selecting Items in the Main Window

You can select one or more boards in the Hostview main window. You can also select one domain in the main window. You must select a set of boards prior to performing certain operations, such as creating a domain.

- To select a single board, click on it with the left mouse button. The selected board is indicated by a black outline, and all other boards are deselected.
- To select additional boards, click on them with the middle mouse button. You can also deselect a currently selected board by clicking on it with the middle mouse button. (The middle mouse button toggles the selection status of the board without affecting the selection status of any other board.)
- To select a domain, click on a board within that domain with the left mouse button. Note that you can select boards from different domains (using the middle mouse button), but the selected domain will correspond to the board that you selected with the left mouse button.

Main Window Menu Bar

The items on the main Hostview menu are described in TABLE 2-1.

TABLE 2-1 Hostview Menu Items

Menu	Submenu Items	Description
File	SSP Logs	Displays a window that shows the SSP messages for a domain or for the platform. For more information, see “SSP Log Files” on page 21.
	Quit	Terminates Hostview.
Edit	Blacklist File	Enables you to specify boards and CPUs to be blacklisted.
Control	Power	Displays a window that enables you to use the <code>power(1M)</code> command. See “To Power Components On or Off From Within Hostview” on page 45.
	Bringup	Displays a window that enables you run <code>bringup(1M)</code> on a domain. See “To Bring Up a Domain From Within Hostview” on page 32.
	Fan	Displays a window that enables you run the <code>fan(1M)</code> command to control the fans within the platform. See “To Control Fans From Within Hostview” on page 55.
Configuration	Board	Enables you to attach and detach system boards. This feature is described in the Sun Enterprise 10000 <i>Dynamic Reconfiguration User's Guide</i> .

TABLE 2-1 Hostview Menu Items (Continued)

Menu	Submenu Items	Description
	Domain	Provides a pull-right menu with several choices. The menu choices enable you to create domains, remove domains, rename domains, obtain the status of domains, and view the history of domains. A domain consists of one or more system boards running the same operating system kernel. Domains function independently of each other. Each domain can carry its own workload and has its own log messages file. For more information, see “To Create Domains From Within Hostview” on page 24 and “To Remove Domains From Within Hostview” on page 28.
Terminal	netcontool	Displays a window that provides a graphical interface to the <code>netcon(1M)</code> command, enabling you to open a network console window for a domain. This menu item is equivalent to executing the <code>netcontool(1M)</code> command. See “Using <code>netcon(1M)</code> ” on page 35.
	SSP	Provides pull-right menu choices that enable you to display an SSP Window in <code>xterm</code> , <code>dterm</code> , <code>shelltool</code> , or <code>cmdtool</code> format with a platform or domain as its host. Select a domain (by selecting any system board within that domain) before choosing this option.
	rlogin	Provides pull-right menu choices that enable you to remotely log in to the selected platform or domain in an <code>xterm</code> , <code>dterm</code> , <code>shelltool</code> , or <code>cmdtool</code> window. Select a domain (by selecting any system board within that domain) before choosing this option.

TABLE 2-1 Hostview Menu Items (*Continued*)

Menu	Submenu Items	Description
View	All Domains	Displays the boards within all domains, as well as any boards that are not part of a domain. (A board can be present without being part of a domain, although a board cannot be used when it is not part of a domain.)
	Individual Domains	When you select an individual domain, only the boards within that domain are displayed. Note that the color of the outline used to designate a given domain is also used as the background color for that domain in the menu. The system board numbers for the boards that belong to each domain are shown in square brackets.
Help	<i>topic</i>	Provides online help information on several topics.

Help Window

When you choose a topic from the Help menu, the Hostview - Help window is displayed (FIGURE 2-5).

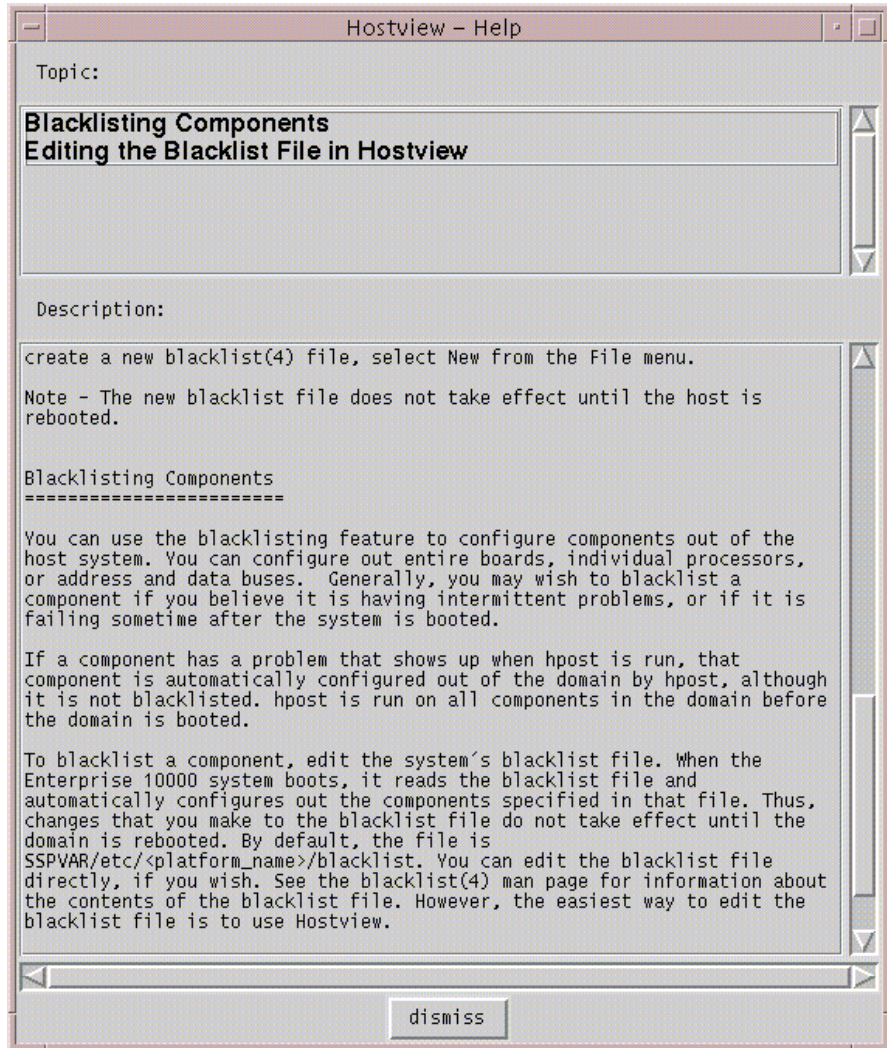

FIGURE 2-5 Hostview Help Window

You can select the desired topic in the upper pane. The corresponding help information is displayed in the lower pane.

Main Window Buttons

The main Hostview window contains the buttons described below. If an out-of-boundary condition exists or an error has occurred, one or more of these buttons turn red.

The Power button (FIGURE 2-6) displays the Power Control and Status window, which enables you to view the power status for the platform. See “To Power Components On or Off From Within Hostview” on page 45.



FIGURE 2-6 Power Button

The Temperature button (FIGURE 2-7) displays the Thermal Status window, which enables you to view the temperature status for the boards and components within the platform. See “To Monitor Thermal Conditions From Within Hostview” on page 51.

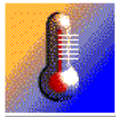

FIGURE 2-7 Temperature Button

The Fan button (FIGURE 2-8) displays the Fan Status window, which enables you to view the status of the fans within the platform. See “To Monitor Fans From Within Hostview” on page 53.



FIGURE 2-8 Fan Button

When certain error conditions occur, the Failure button (FIGURE 2-9) turns red. If you click a red Failure button, a window is displayed showing the error condition(s) that have occurred.



FIGURE 2-9 Failure Button

TABLE 2-2 describes the types of error conditions that are trapped by this mechanism.

TABLE 2-2 Error Conditions

Error	Description
Host panic recovery in progress	The operating system on a domain has failed and is recovering.
Heartbeat failure recovery in progress	The SSP was not receiving updated platform or domain information as expected.
Arbitration stop recovery in progress	A parity error or other fatal error has occurred, and the domain is recovering. See <i>arbitration stop</i> in the glossary.

Main Window Processor Symbols

In the main window, the shape and background color of a processor symbol indicate the status of that processor. For example, a diamond on a green background indicates the processor is running the operating system.

TABLE 2-3 lists the shapes and what the processor is running for each shape.

TABLE 2-3 Processor Symbol Shapes

Shape	Processor running
Diamond	Operating system
Circle	hpost(1M)

TABLE 2-3 Processor Symbol Shapes

Shape	Processor running
Square	download_helper
Triangle	OBP
?	Unknown program

TABLE 2-4 lists the possible colors for processor symbols and the processor state indicated by each color.

TABLE 2-4 Processor Color Scheme

Color	State
Green	Running
Maroon	Exiting
Yellow	Prerun (The OS is currently being loaded.)
Blue	Unknown
Black	Blacklisted (The processor is unavailable to run programs or diagnostics.)
Red	Redlisted (The processor is unavailable to run programs or diagnostics and its state may not be changed.)
White	Present but not configured (The processor is unavailable, but not blacklisted or redlisted. One example is a board that has been hot-swapped in, but it has not yet been attached to the operating system.)

Hostview Performance Considerations

Each instance of Hostview requires up to 10 Mbytes of the available swap space in the SSP. Before running multiple copies of Hostview, make sure the SSP has sufficient swap space available. For example, if you plan to run three instances of Hostview, make sure you have at least 30 Mbytes of swap space.

SSP Log Files

When you perform procedures on an SSP, error messages for a particular domain are logged in the file:

```
$SSPLOGGER/domain_name/messages
```

where *domain_name* is the host name of the domain for which the error occurred.

Error messages for the platform that are not specific to a domain are logged in the `$SSPLOGGER/messages` file. The SSP environment variables, such as `SSPLOGGER`, are described in “Environment Variables” on page 83.

▼ To View a messages File From Within Hostview

1. Select the appropriate board.

- If you want to view the `messages` file for a particular domain, select that domain in the main Hostview window (by clicking on a board from that domain with the left mouse button).
- If you want to view the `messages` file for the platform, make sure that no domain is selected.

2. Choose SSP Logs from the File menu.

The SSP Logs window is displayed (FIGURE 2-10).

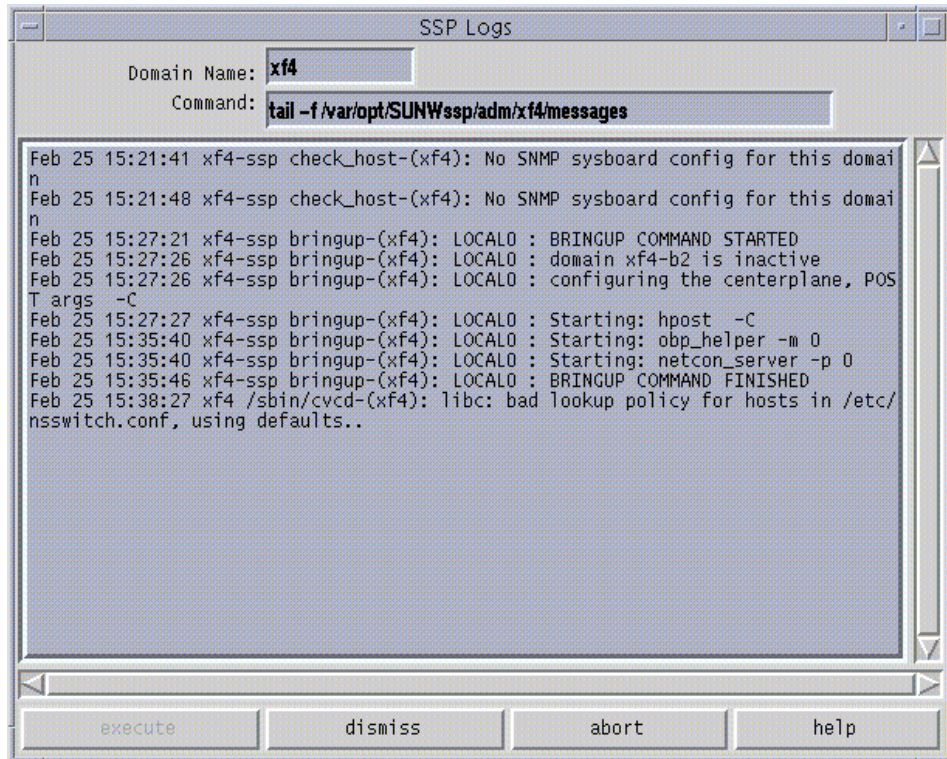

FIGURE 2-10 SSP Logs Window

The Domain Name field shows the name of the domain that you selected. The messages file is displayed in the main panel of the window.

Domain Administration

The SSP supports commands that let you logically group system boards into Dynamic System Domains, or simply *domains*, which are able to run their own operating system and handle their own workload. Domains can be created and deleted without interrupting the operation of other domains. You can use domains for many purposes. For example, you can test a new operating system version or set up a development and testing environment in a domain. In this way, if problems occur, the rest of your system is not affected.

You can also configure several domains to support different departments, with one domain per department. You can temporarily reconfigure the system into one domain to run a large job over the weekend.

Domain Configuration Requirements

You can create a domain out of any group of system boards, provided the following conditions are met:

- The boards are present and not in use in another domain.
- At least one board has a network interface.
- The boards have sufficient memory to support an autonomous domain.
- The name you give the new domain is unique (as specified in the `domain_create(1M)` command) and this name matches the host name of the domain to be booted (as specified by the `SUNW_HOSTNAME` environment variable).
- You have an `eeprom.image` file for the domain that was shipped to you by the factory. If your `eeprom.image` file has been accidentally deleted or corrupted and you do not have a backup, see “To Recreate the `eeprom.image` File” on page 27.

There must be at least one boot disk connected to one of the boards that will be grouped together into a domain. Alternatively, if a domain does not have its own disk, there must be at least one network interface so that you can boot the domain from the network.

▼ To Create Domains From Within Hostview

Note – Before proceeding, read the requirements in the previous section, “Domain Configuration Requirements”. If the system configuration must be changed to meet any of these requirements, call your service provider.

- 1. Click the left mouse button on the first board.**
- 2. Click the middle mouse button on any additional boards.**
Ensure that the boards you select do not currently belong to any domain.
- 3. Choose Domain then Create from the Configuration menu.**
The Create Domain window is displayed (FIGURE 3-1).

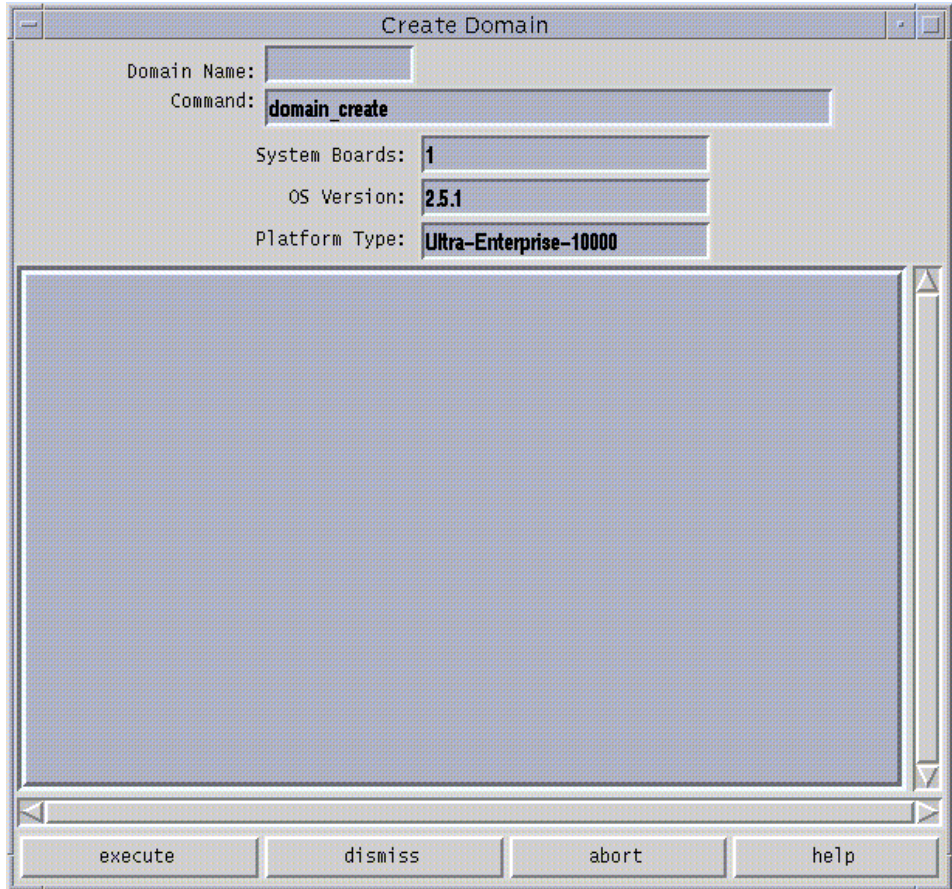

FIGURE 3-1 Create Domain Window



Caution – You must be sure to specify the proper OS Version number for the domain you are creating. The default is 2.5.1. Edit this version number, if necessary, to reflect the version of the operating system for the domain you are creating.

4. Type the domain name.

The name of the domain must be the one given to you by the factory and contained in the `eeeprom.image` file. It cannot be an arbitrary name.

5. If all other fields are acceptable, click execute.

Note that the System Boards field indicates the boards that you selected in the main Hostview window. The default OS version and the default platform type are shown. If Hostview successfully executes the command, it displays the message `Command completed` in the informational panel of the window.

Note – Hostview can run only one `create` or `remove` command at a time. If you attempt to execute a second `create` or `remove` command before the first has completed, your second attempt fails.

▼ To Create Domains From the Command Line

Note – Before proceeding, see “Domain Configuration Requirements” on page 23. If the system configuration must be changed to meet any of these requirements, call your service provider.

1. In an SSP window, type:

```
ssp% domain_create -d domain_name -b system_board_list -o os_version -p platform_name
```

where:

domain_name is the name you want to give to the new domain. It should be unique among all Sun Enterprise 10000 systems controlled by the SSP.

system_board_list specifies the boards that are to be part of this domain. The specified system boards must be present and not in use. Each domain must have a network interface, SCSI interface, and sufficient memory to support an autonomous system. List the board numbers, separated by commas or spaces, for all boards you want to include.

os_version is the version of the operating system to be loaded into the domain.

platform_name is the name of the platform managed by the SSP.

2. Optionally, create a new SSP window for the domain, as described in “SSP 3.2 Window” on page 4.

Use the `domain_switch(1M)` command to set the `SUNW_HOSTNAME` environment variable to the new domain name.

▼ To Recreate the `eeeprom.image` File

Note – You cannot create a domain if you do not have the corresponding `eeeprom.image` file. The `eeeprom.image` files for the domains you ordered are shipped to you by the factory. If you accidentally delete an `eeeprom.image` file or your boot disk is corrupted, and you do not have a backup copy of your `eeeprom.image` file, you can contact your Sun service representative to recreate it. Alternatively, you may be able to recreate the `eeeprom.image` file if you have the original serial number and the EEPROM key. In this case, follow the steps in this procedure.

1. Log in to the SSP as user `ssp`.
2. Recreate the `eeeprom.image` file.

Note – All `key` and `host_id` numbers are case sensitive and must be entered exactly as they are received.

a. For the first domain, type:

```
ssp% domain_switch domain_name
ssp% sys_id -k key -s serial_number
```

where:

domain_name is the hostname of the domain

key is the `eeeprom` key number

serial_number is the number provided with the *key* in the form of `0XA65xxx`

b. For all subsequent domains, type:

```
ssp% domain_switch domain_name
ssp% sys_id -k key -h hostid
```

where:

domain_name is the hostname of the domain.

key is the `eeeprom` key number.

hostid is the number provided with the *key* in the form of `0X80A66xxx`.

3. Check the result by typing:

```
ssp% sys_id -d
```

In the following example, 49933C54C64C858CD4CF is the key and 0x80a66e05 is the *host_id*:

```
ssp% domain_switch domain_name
ssp% sys_id -k 49933C54C64C858CD4CF -h 0x80a66e05
ssp% sys_id -d

IDPROM in eeprom.image.domain_name

          Format = 0x01
        Machine Type = 0x80
    Ethernet Address = 0:0:be:a6:6e:5
    Manufacturing Date = Wed Dec 31 16:00:00 1998
Serial number (machine ID) = 0xa66e05
          Checksum = 0x3f
```

4. Back up the SSP `eeprom.image` files to tape or disk where they can be accessed in case of SSP boot disk failure.

▼ To Remove Domains From Within Hostview

1. In the main Hostview window, click any board in the domain to be removed.
2. Choose Domain then Remove from the Configuration menu.

The Remove Domain window is displayed (FIGURE 3-2 on page 29).

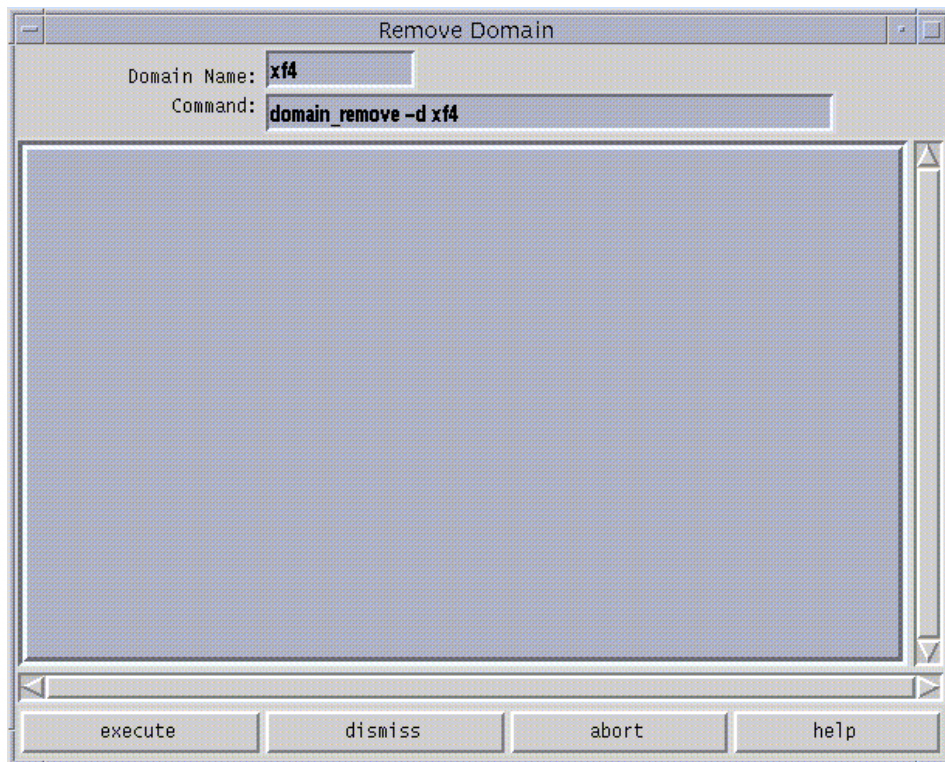

FIGURE 3-2 Remove Domain Window

3. If the default `domain_remove(1M)` command is satisfactory, click the **execute** button; otherwise, edit the command first.

For help on the `domain_remove(1M)` command, click the help button. A help window is displayed (see “Help Window” on page 16).

4. Specify whether or not domain subdirectories should be removed when you are prompted to do so.

The pathnames of the subdirectories are displayed. These subdirectories contain domain-specific information such as message files, configuration files, and `hpost(1M)` dump files. You can keep these directories if you still need the information. It is easier to recreate a domain if you keep these directories.

Note – If the system cannot remove your domain, see `domain_remove(1M)` for a list of potential errors.

▼ To Remove Domains From the Command Line

1. Type:

```
ssp% domain_remove -d domain_name
```

You must execute this command in an SSP window in which the `SUNW_HOSTNAME` environment variable is set to the name of the domain you want to remove. The domain must not be running the operating system.

2. Specify whether or not domain subdirectories should be removed when you are prompted to do so.

The pathnames of the subdirectories are displayed. These subdirectories contain domain-specific information such as message files, configuration files, and `hpost(1M)` dump files. You can keep these directories if you still need the information. The domain can be recreated whether or not you keep this information.

3. Type `domain_status(1M)` to verify that the domain was removed.

Note – If the system cannot remove your domain, an error message is displayed. See `domain_remove(1M)` for a list of potential errors.

▼ To Rename Domains From Within Hostview

Note – After you rename a domain, you must also update `/etc/hosts` to reflect the domain's new name.

1. Shut down the domain.

2. In the main Hostview window, select a board from the domain that you want to rename by clicking on it with the left mouse button.

3. Choose Domain then Rename from the Configuration menu.

The Rename Domain window is displayed (FIGURE 3-3).

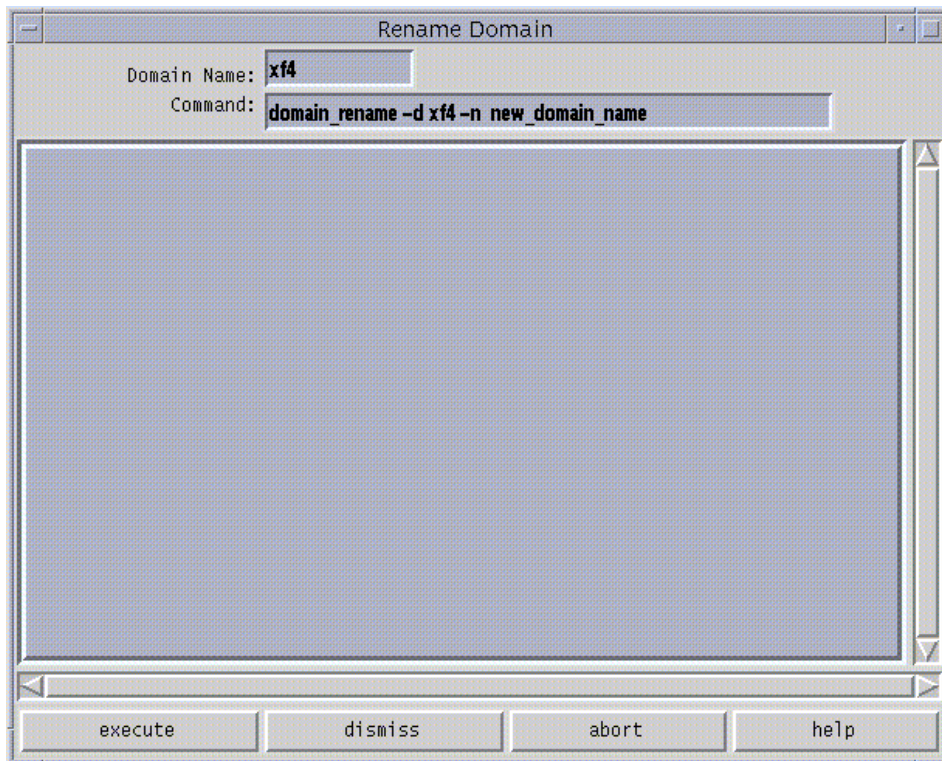

FIGURE 3-3 Rename Domain Window

4. If the default `domain_rename(1M)` command is satisfactory, click on the **execute** button. Otherwise, edit the command first.

For help on the `domain_rename(1M)` command, click on the help button. A help window is displayed (see “Help Window” on page 16).

▼ To Rename Domains From the Command Line

Note – After you rename a domain, you must also update the standard host configuration files to reflect the domain’s new name. See the Solaris 2.6 User Collection or Solaris 7 User Collection and the Solaris 2.6 System Administrator Collection Vol 1 or Solaris 7 System Administrator Collection.

- **Type:**

```
% domain_rename -d old_domain_name -n new_domain_name
```

For more information, see the `domain_rename(1M)` man page.

▼ To Bring Up a Domain From Within Hostview

1. **Use the mouse to select any system board belonging to the domain you want to bring up.**
2. **Choose Bringup from the Control menu.**
A window is displayed that shows the name of the selected domain.
3. **Click `Execute` to perform the bringup.**
4. **After the `bringup` operation has completed, choose `netcontool` from the Terminal menu.**
5. **Click the `Connect` button to open a `netcon(1M)` window.**
6. **If the OBP prompt appears (that is, the `OK` prompt), boot the domain:**

```
OK boot boot_device
```

The domain should boot and then display the login prompt. Note that you can use the OBP command `devalias` to determine the alias for the disk you want to use as `boot_device`.

▼ To Bring up a Domain From the Command Line

Before you can bring up a domain from the command line in an SSP window, the system boards for the domain must be powered on. Ensure that the `SUNW_HOSTNAME` environment variable is set to the proper valid domain name.

1. **Set the `SUNW_HOSTNAME` environment variable by typing:**

```
ssp% domain_switch domain_name
```

where `domain_name` is the name of the domain you want to bring up.

2. Power on the power supplies for all of the boards in the domain:

```
ssp% power -on
```

3. Bring up the domain by typing:

```
ssp% bringup -A [off/on] [disk]
ssp% netcon
ok boot
```

The `-A` option is the autoboot option. If the autoboot option is on, the domain will automatically boot. If it is off, you need to explicitly boot the domain.

▼ To Obtain Domain Status From Within Hostview

- **Choose Domain then Status from the Configuration menu.**

The Domain Status window is displayed (FIGURE 3-4).

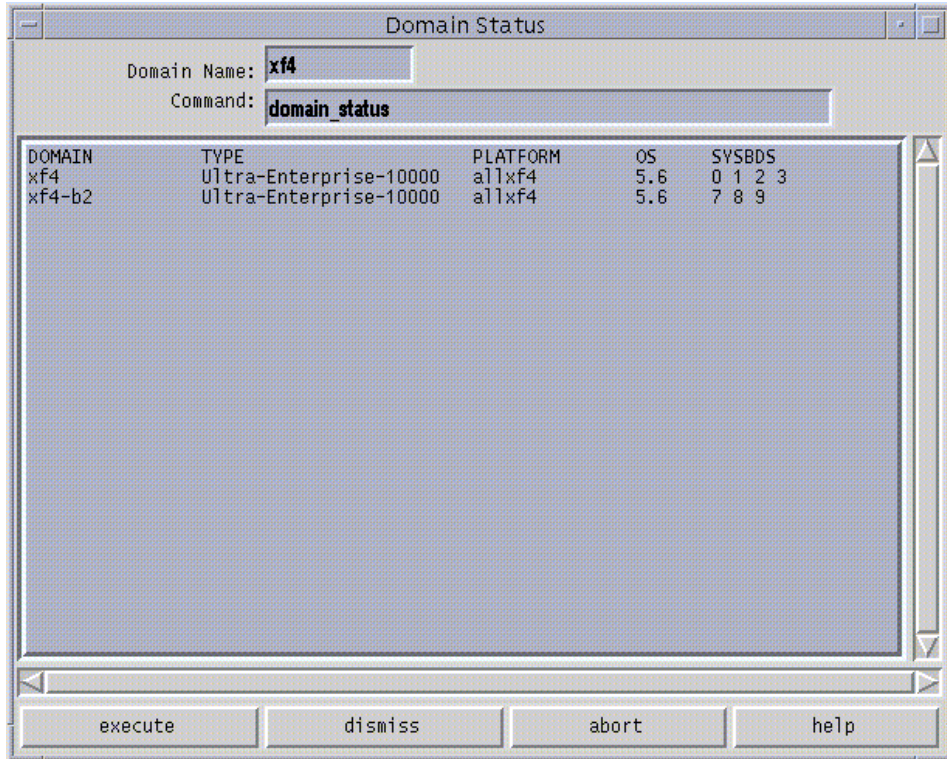

FIGURE 3-4 Domain Status Window

The status listing is displayed in the main panel of the window. The following table explains the columns in the Domain Status window.

TABLE 3-1 Domain Status Columns

Name	Description
DOMAIN	Lists the name of the domain.
TYPE	Lists the platform type. It can only have the value Ultra-Enterprise-10000 in the current release.
PLATFORM	Lists the name of the platform. The platform name is set at the time the SSP packages are installed.
OS	Lists the operating system version for the domain.
SYSBDS	Lists the system boards that make up the domain.

netcon and netcontool

This chapter describes `netcon(1M)` and `netcontool(1M)`, the GUI front-end to the `netcon(1M)` command. `netcontool(1M)` simplifies the process of configuring and bringing up `netcon(1M)` windows. You can also use the `netcon(1M)` command directly to display a `netcon(1M)` window. However, when using `netcon(1M)`, you must know escape sequences to perform operations that can be performed by clicking on buttons under `netcontool(1M)`.

Using netcon(1M)

The `netcon(1M)` command is similar to `netcontool(1M)` except that no GUI interface is provided, making it more functional for dial-in or other low-speed network access. Typically, you log in to the SSP machine as user `ssp`, and enter the `netcon(1M)` command in an SSP window. For example:

```
ssp% domain_switch domain_name
ssp% netcon
```

This action changes the window in which you run the `netcon(1M)` command into a `netcon(1M)` window for the domain specified by the `domain_switch(1M)` command. Multiple `netcon(1M)` windows can be open simultaneously, but only one at a time can have write privileges to a specific domain. When a `netcon(1M)` window is in read-only mode, you can view messages from the `netcon(1M)` window, but you cannot enter any commands.

You can specify the `netcon(1M)` `-g` option for Unlocked Write permission, `-l` for Locked Write permission, `-f` to force Exclusive Session mode, or `-r` for read-only mode. See the `netcon(1M)` man page for an explanation of how `netcon(1M)` behaves if you do not specify any of these arguments.

If you have write permission, you can enter commands. In addition, you can enter special commands with the tilde (~) prefix to perform the functions offered by the `netcontool(1M)` window.

If `netcon(1M)` displays the following message, “`netcon_server` is not running for `domain_name`”, the domain may not be up. If it is up, you can run “`netcon_server -r &`” to restart `netcon_server(1M)`.

▼ To Start `netcon(1M)` From the Command Line

- **Log in to the SSP as user `ssp` and type:**

```
ssp% domain_switch domain_name
ssp% netcon
```

▼ To Start `netcon(1M)` From the CDE Front Panel

1. **From the CDE front panel, select the `SSP` subpanel and then select the `netcon` option.**
2. **Specify the domain name when prompted to do so.**

▼ To Start `netcon(1M)` From the CDE Workspace Menu

1. **From the CDE Workspace menu (right click), choose `SSP` and then choose `netcon`.**
2. **Specify the domain name when prompted to do so.**

▼ To Exit From a netcon(1M) Window

- Type a tilde (~) followed by a period in the netcon(1M) window:

```
# ~.
```

If you enter the tilde period sequence locally at the SSP workstation or remotely through a telnet(1) session, your netcon(1M) session is terminated and the window returns to its previous state. However, if you enter the tilde period sequence remotely through an rlogin(1) session, the netcon(1M) session is terminated *and* the rlogin(1) window is deleted as well. This is because the tilde period sequence is recognized by rlogin(1) as an exit command. If you want to avoid this behavior, you can use the sequence ~~, that is, tilde tilde period, to exit from a netcon(1M) window running inside of an rlogin(1) session. For more information about escape sequences, see the netcon(1M) manual page.

Using netcontool(1M)

The netcontool(1M) GUI program provides the buttons shown in FIGURE 4-1.

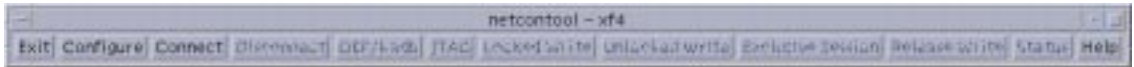

FIGURE 4-1 netcontool GUI Program

TABLE 4-1 explains the netcontool(1M) buttons.

TABLE 4-1 netcontool buttons

Button	Description
Configure	Displays the Console Configuration window. See “To Configure the netcontool(1M) Window” on page 40.
Connect	Displays the netcon(1M) window and initiates the connection process.
Disconnect	Disconnects the console window from the domain and removes the console window. The netcontool(1M) window is still available so that you can reconfigure for another connect session.
OBP/kadb	Breaks to the OpenBoot™ PROM (OBP) or kadb(1M) programs.

TABLE 4-1 netcontool buttons

Button	Description
JTAG	Toggles the SSP-to-platform connection between a network connection and a JTAG connection.
Locked Write, Unlocked Write, and Exclusive Write	Request the corresponding mode for the console window. For an explanation of the meaning of these modes, see “To Configure the netcontool(1M) Window” on page 40.
Release Write	Releases write access and places the console in read only mode.
Status	Displays information about all open consoles that are connected to the same domain as the current session, as well as the connection type currently used.
Help	Displays information about the netcontool(1M) window.
Exit	Exits the program and removes the netcon(1M) window if it is still open.

▼ To Display a netcontool(1M) Window From the Command Line

- **Log in to the SSP as user `ssp` and type:**

```
ssp% domain_switch domain_name
ssp% netcontool &
```

▼ To Display a netcontool(1M) Window From the CDE Front Panel

- 1. From the CDE front panel, select the SSP subpanel and then select the netcontool option.**
- 2. Specify the domain name when prompted to do so.**

▼ To Display a netcontool(1M) Window From the CDE Workspace Menu

1. From the CDE Workspace menu (right click), choose SSP and then choose netcontool.
2. Specify the domain name when prompted to do so.

▼ To Display the netcontool(1M) Window From Hostview

1. Select a board from the domain for which you want to display a netcontool(1M) window by clicking on that board with the left mouse button.
2. Select Terminal % netcontool.
3. In the netcontool(1M) window, click the Connect button.

The netcontool(1M) window (FIGURE 4-2) is displayed beneath the netcontool(1M) buttons.

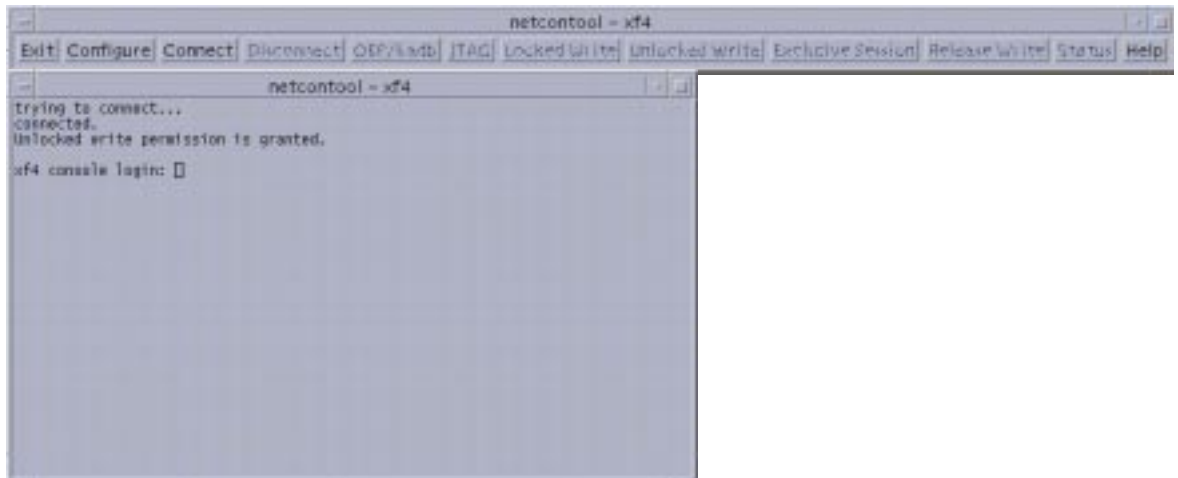

FIGURE 4-2 netcontool Window in Hostview

▼ To Configure the netcontool(1M) Window

1. Click the **Configure** button if you want to configure the netcontool(1M) window before you display a netcon(1M) window.

The Console Configuration window is displayed (FIGURE 4-3).

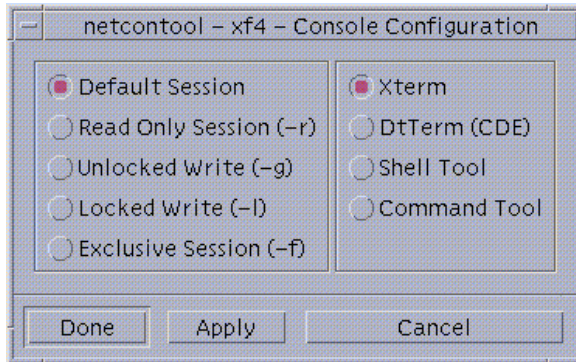

FIGURE 4-3 netcontool Console Configuration Window

2. Select the session type in the left panel, and the terminal emulation type in the right panel.

3. When you are satisfied with the contents of the window, click Done to accept the settings and dismiss the window, or click Apply to accept the settings without dismissing the window.

The following table contains the options in the Console Configuration window.

TABLE 4-2 Console Configuration Options

Console	Options
Default Session	This causes the default type of session to be started. If no other session is running, the default is unlocked-write mode. If any other session is running, the default is read-only mode.
Read Only Session	Displays a console window where you can view output from a domain, but you cannot enter commands.
Unlocked Write Session	Attempts to display a <code>netcon(1M)</code> window with unlocked write permission. If this attempt succeeds, you can enter commands into the console window, but your write permission is taken away whenever another user requests Unlocked Write, Locked Write, or Exclusive Session permission for the same domain. <ul style="list-style-type: none">• If another user currently has Unlocked Write permission, it is changed to read-only permission, and you are granted Unlocked Write permission.• If another user currently has Locked Write permission, you are granted read-only permission.• If another user currently has Exclusive Session permission, you are not allowed to display a <code>netcon(1M)</code> window.• If you are granted Unlocked Write permission and another user requests Unlocked Write or Locked Write permission, you are notified and your permission is changed to read only. You can attempt to re-establish Unlocked Write permission at any time, subject to the same constraints as your initial attempt to gain Unlocked Write permission.

TABLE 4-2 Console Configuration Options (*Continued*)

Console	Options
Locked Write	Attempts to display a console window with Locked Write permission. <ul style="list-style-type: none">• If you are granted Locked Write permission, no other user can remove your write permission unless they request Exclusive Session permission.• If another user currently has Locked Write permission, you are granted read-only permission.• If another user currently has Locked Write permission, you are granted read-only permission.• If another user currently has Exclusive Session permission, you are not allowed to display a <code>netcon(1M)</code> window.
Exclusive Session	Displays a console window with Locked Write permission, terminates all other open console sessions for this domain, and prevents new console sessions for this domain from being started. You can change back to multiple session mode by clicking the Release Write button to release write access, or by clicking the Disconnect button to terminate your console session for the domain. You can also simply quit from the console window (using the Control menu of the window). You are not granted Exclusive Session permission if any other user currently has Exclusive Session permission.
Terminal Emulation Type	The <code>netcon(1M)</code> window is brought up in the specified type of window. The default is <code>xterm(1)</code> . <code>dtterm(1)</code> is only available if you are running the Common Desktop Environment (CDE), otherwise it is grayed out. You can also use <code>shelltool(1)</code> or <code>cmdtool(1)</code> .

netcon(1M) Communications

`netcon(1M)` uses two distinct paths for communicating console input/output between the SSP and a domain: the standard network interface and the CBE interface. When the domain is up and running, console traffic usually flows over the network. If the local network becomes inoperable, all interactive access to the domain is lost and, for example, `telnet`, `rlogin`, and `netcon(1M)` sessions hang. In this case, you can switch to the CBE interface and access the host's console window. To perform this switch, use the `~=` command in the `netcon(1M)` window.

netcon(1M) Message Logging

Certain messages sent from the kernel are not displayed in the syslog messages file, such as OpenBoot messages, panic messages, and some console messages. `syslogd(1M)` must run on the host to log the messages; this is not possible when a panic occurs, nor is it possible at certain times during the boot sequence. Moreover, panic dumps often fail, so these types of messages may not even appear in a dump file to help you determine the cause of the failure.

However, you can capture all output displayed on an active `netcon(1M)` console through the LOCAL1 facility of `syslog(1M)` and the SSP `machine_server(1M)` daemon. This functionality is enabled through the `/etc/syslog.conf` and `$$$SPLOGGER/.logger` files. When enabled, `netcon(1M)` session output is recorded in the `$$$SPLOGGER/domain_name/netcon` file, where `$$$SUNW_HOSTNAME` is set to the host name for the domain. By default, this functionality is disabled.

▼ To Enable `netcon(1M)` Logging

1. In the file `/etc/syslog.conf`, uncomment the `local1.debug` line.
2. Force `syslogd` to reread its configuration file:

```
ssp# kill -HUP `cat /etc/syslog.pid`
```

▼ To Disable `netcon(1M)` Logging Sessions for Specific Hosts

Once logging of `netcon` sessions is enabled as shown above, logging can be disabled for specific domains.

- Start `netcon_server` with the `-S` flag for a specific domain.

```
ssp% domain_switch domain_name  
ssp% netcon_server -r -S &
```

The `S` flag, to suspend `netcon` session output, can also be used with `bringup`, which passes the flag on to `netcon_server`, for example:

```
ssp% bringup -S
```

Either method disables output for `netcon` sessions when otherwise enabled with the `syslog.conf` and `.logger` files.

▼ To Re-Enable `netcon(1M)` Logging Sessions for Specific Hosts

If you have disabled `netcon(1M)` logging as described in “To Disable `netcon(1M)` Logging Sessions for Specific Hosts”, you can re-enable `netcon(1M)` logging.

- **Start** `netcon_server`:

```
ssp% domain_switch domain_name  
ssp% netcon_server -r &
```

Power Administration

This chapter describes how to control the system power resources from within Hostview or from the command line, to control the peripherals power resources from the command line, and to monitor the power levels in Hostview.

▼ To Power Components On or Off From Within Hostview

Note – If you are powering off a board to replace it, use the `power(1M)` command. Do not use the breakers to power off the board; this can cause an arbstop.

- 1. Click the left mouse button to select a board in the main Hostview window.**
- 2. Choose Power from the Control menu.**

The Power Control and Status window is displayed (FIGURE 5-1 on page 46).

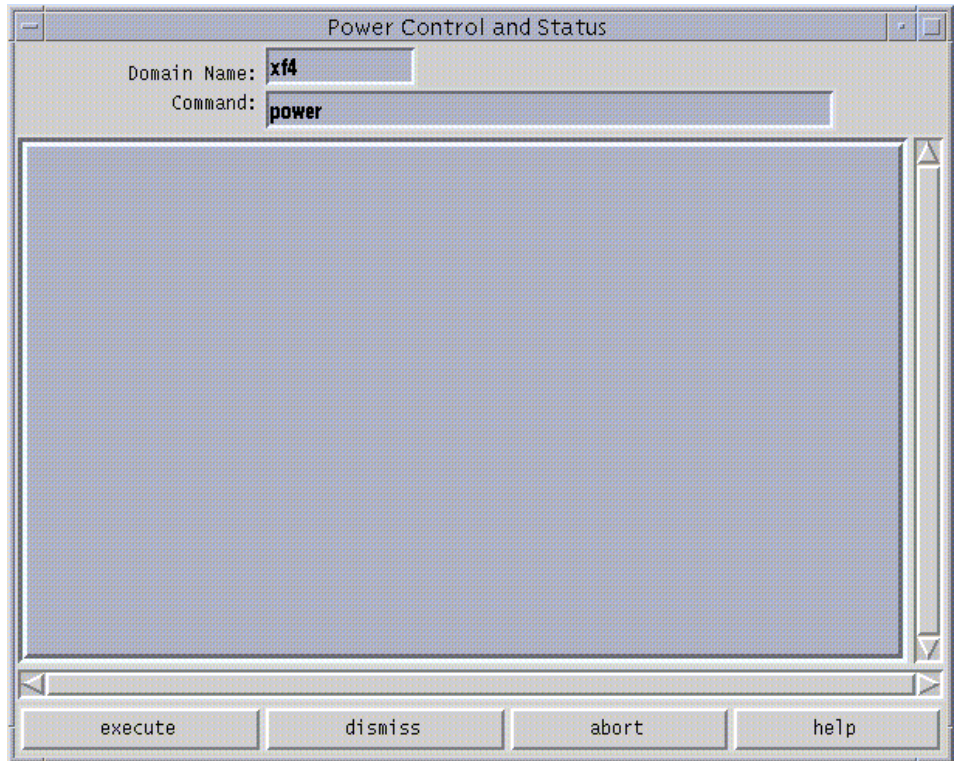

FIGURE 5-1 Power Control and Status Window

The default `power(1M)` command is displayed in the Command field.

3. Optionally, add options to the `power(1M)` command.

4. Click the Execute button (or press Return) to run the command.

The results are shown in the main panel of the window.

5. For information about the `power(1M)` command, click the Help button.

A help window is displayed. See “Help Window” on page 16.

After powering on the necessary components, you can run the `bringup(1M)` commands on the SSP for the domains you want to boot. See “To Bring Up a Domain From Within Hostview” on page 32.

If you try to power off the system while any domain is actively running the operating system, the command fails and a message is displayed in the message panel of the window. In this case, you have two choices. You can force a power off by executing the `power(1M)` command again with the `f` (force) option. Or, you can issue a `shutdown(1M)` or similar command for the active domain(s) to gracefully

shut down the processors, and then reissue the command to power off. Using `shutdown(1M)` ensures that all resources are de-allocated and users have time to log out before the power is turned off. To use `shutdown(1M)`, you must be logged in to the domain as superuser.

If the platform loses power due to a power outage, Hostview displays the last state of each domain before power was lost.

▼ To Power System Boards On and Off From the Command Line

- To power on system boards, type:

```
ssp% power -on -sb board_list
```

where *board_list* is a list of system boards separated by spaces, such as
3 5 6.

Note – If you are powering off a board to replace it, use the `power(1M)` command. Do not use the breakers to power off the board; this can cause an arbstop.

- To power off system boards, type:

```
ssp% power -off -sb board_list
```

where *board_list* is a list of system boards separated by spaces, such as
3 5 6.

For more information, see the `power(1M)` man page.

▼ To Monitor Power Levels in Hostview

1. Click the Power button.



FIGURE 5-2 Power Button

The Power Status Display window is displayed (FIGURE 5-3 on page 48).

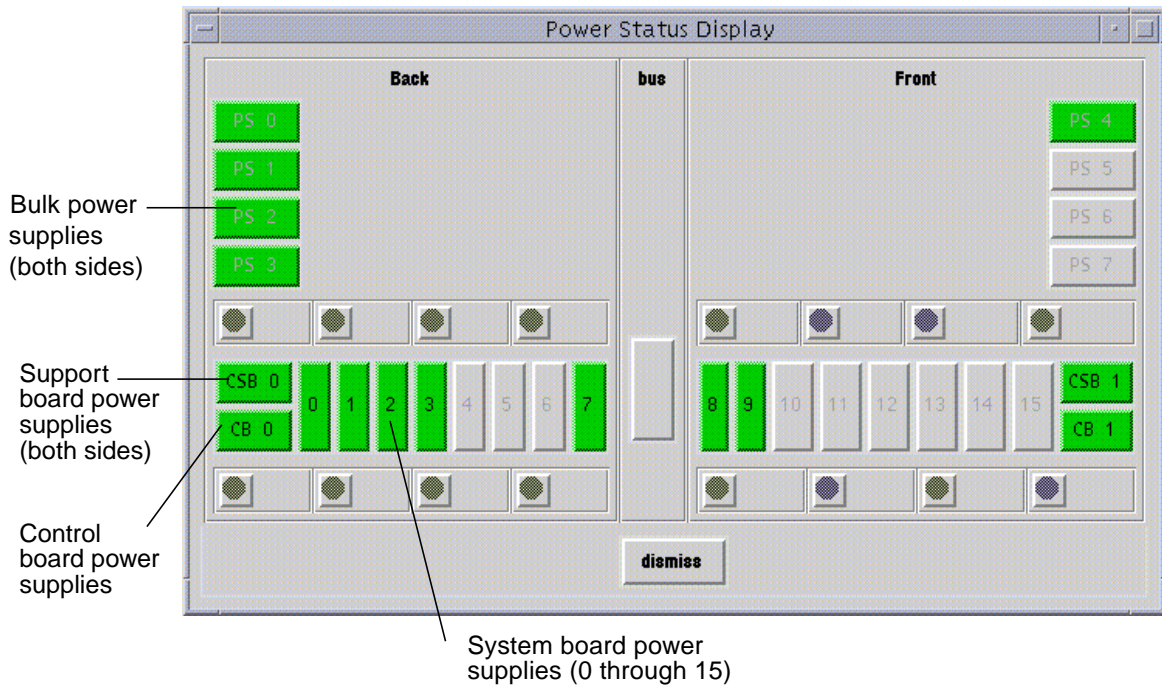

FIGURE 5-3 Power Status Display

In FIGURE 5-3, the bulk power supplies are named PS0 through PS07. The system board power supplies are numbered 0 through 15. The support board power supplies are named CSB0 and CSB1. The control board power supplies are named CB0 and CB1.

Power supplies can be colored green, red, or gray. A green power supply is functioning properly. A red power supply has failed. A gray power supply is not present.

2. Click on a system board.

The Power Detail window for that board is displayed (FIGURE 5-4 on page 49).

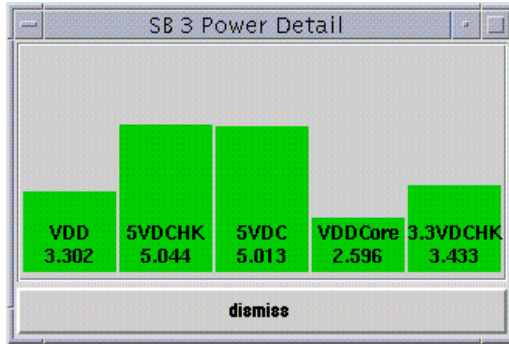

FIGURE 5-4 System Board Power Detail Window

The Power Detail window shows the voltage for each of the five power supplies on the board. The power levels are indicated in volts. The bars give a visual representation of the relative voltage levels so that you can monitor them more easily. If a bar is green, the voltage level is within the acceptable range. If a bar is red, the voltage level is either too low or too high. (Thus, a red bar can be short or tall.) The bars never grow taller than the height of the window, so voltage levels that exceed the maximum threshold are displayed as red maximum-height bars. Similarly, bars never shrink below a minimum height, so voltage levels below the minimum threshold are displayed as red minimum-height bars.

The only difference between the detail for a system board and the detail for a control board or support board is the number of power supplies.

Thermal Conditions Administration

This chapter describes how to administer the thermal conditions and fans from within Hostview and how to monitor and control the fans from within Hostview.

▼ To Monitor Thermal Conditions From Within Hostview

You can use Hostview to monitor thermal conditions for power supplies, processors, ASICs, and other sensors located on system boards, support boards, controller boards, and the centerplane.

1. **Click the Temperature button.**

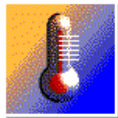

FIGURE 6-1 Temperature Button

The Thermal Status Display window is displayed (FIGURE 6-2 on page 52).

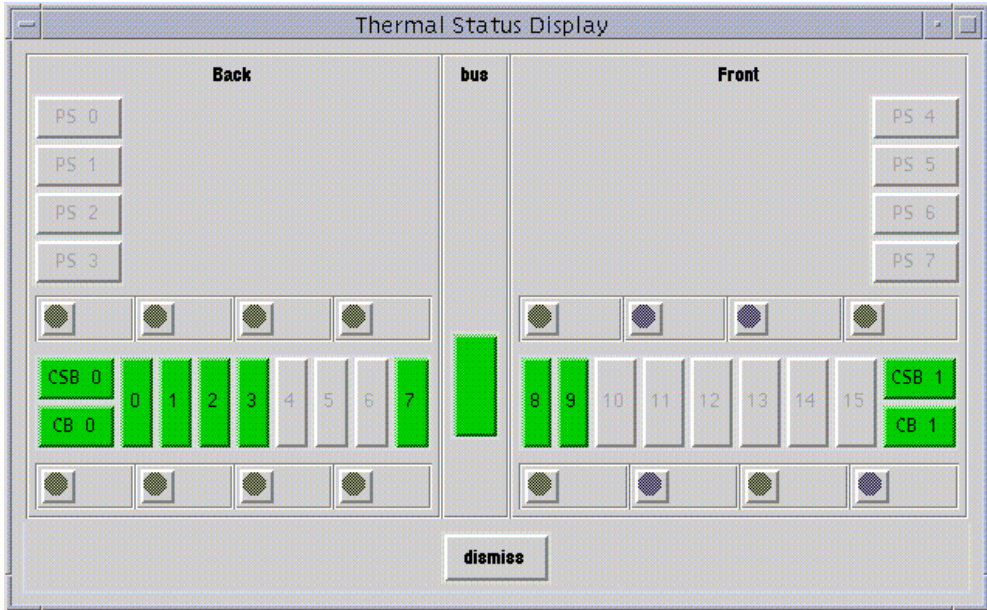

FIGURE 6-2 Thermal Status Display

The centerplane, support boards, control boards, and system boards are shown in green if their temperatures are in the normal range, and in red otherwise.

2. Click on a component with the left mouse button to see the thermal details about that component.

The Thermal Detail window for that component is displayed (FIGURE 6-3 on page 53).



FIGURE 6-3 System Board Thermal Detail

The left panel of the system board detail shows the temperatures for the five ASICs, named A0 through A4. The middle panel shows the temperatures for the three power supplies. The right panel shows the temperatures for the four processors, named P0 through P3.

The temperatures are displayed in degrees centigrade, and the values are shown numerically and as vertical bars. The vertical bars are colored green if the temperature is within the normal range, and red otherwise. The bars never grow taller than the height of the window, so temperature levels above the maximum threshold are displayed as red maximum-height bars. Similarly, bars never shrink below a minimum height, so temperature levels below the minimum threshold are displayed as red minimum-height bars.

The detail windows for control boards, support boards, and the center plane are similar.

▼ To Monitor Fans From Within Hostview

You can use Hostview to monitor fan speeds and fan failures for the 32 fans located throughout the Sun Enterprise 10000 platform.

1. Click on the Fan button.

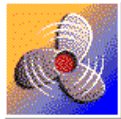

FIGURE 6-4 Fan Button

The Fan Status Display window is displayed (FIGURE 6-5 on page 54).

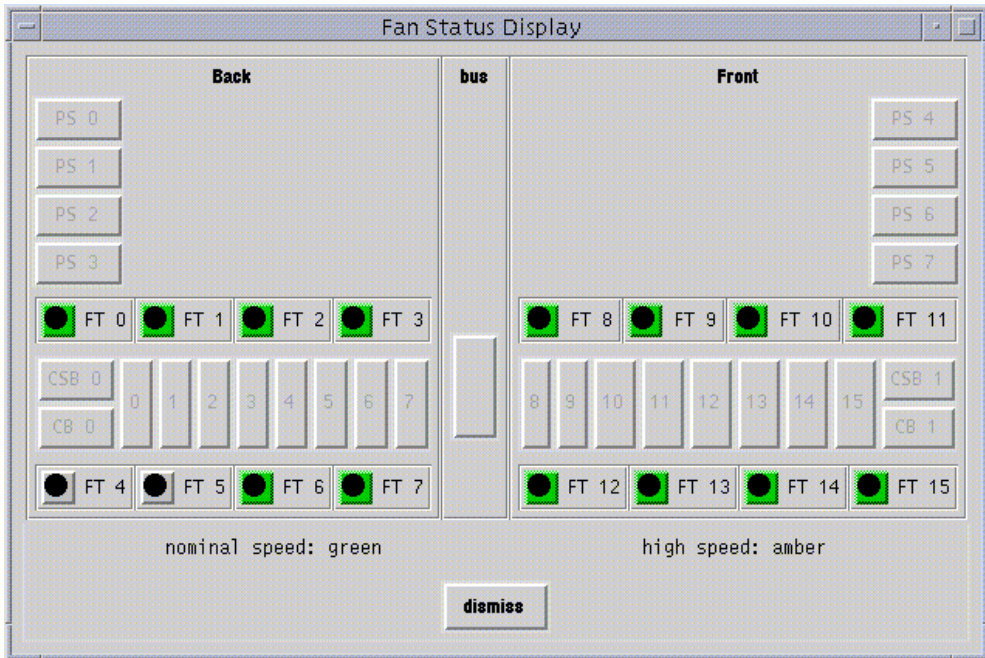

FIGURE 6-5 Fan Status Display

The fan trays are named FT0 through FT7 on the back, and FT8 through FT15 on the front. Each fan tray contains two fans. The color of the fan tray symbol is green if both fans in the tray are functioning at normal speed, amber if both fans are functioning at high speed, and red if either fan within the fan tray has failed.

2. **Click on a fan tray symbol with the left mouse button to see a detail window about that fan.**

The Fan Tray window is displayed (FIGURE 6-6 on page 55).

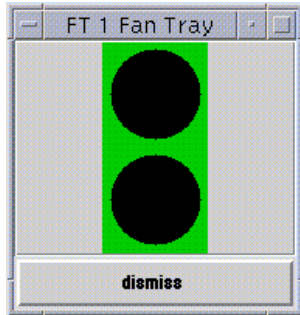

FIGURE 6-6 Fan Tray Window

The top circle indicates the inner fan when you open the fan tray, and the lower circle indicates the outer fan. The color surrounding each circle in the fan detail indicates the status of that fan. The colors are green for normal operation at normal speed, amber for normal operation at high speed, and red for failure.

▼ To Control Fans From Within Hostview

You can control fan power and speed from within Hostview.

1. Choose Fan from the Control menu.

The Fan Control and Status window is displayed (FIGURE 6-7 on page 56).

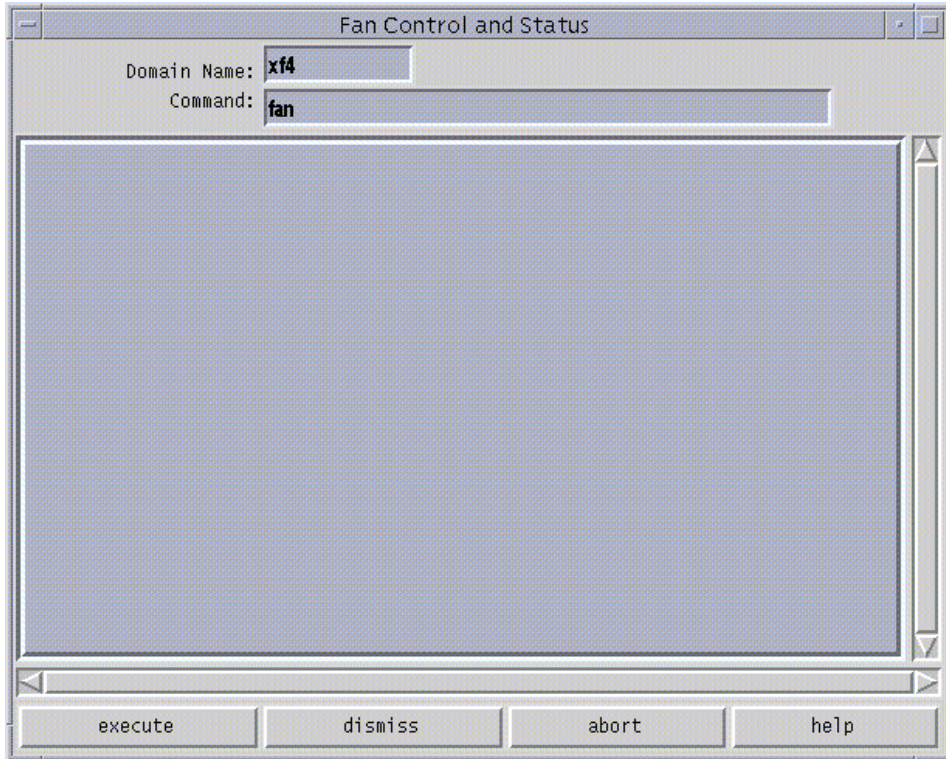

FIGURE 6-7 Fan Control and Status Window

The Domain Name field shows the selected domain from the platform to which Hostview is connected. The `fan(1M)` command is shown in the Command field without any options.

- 2. Add the desired set of options to the `fan(1M)` command, and click the execute button (or press Return).**

For example, if you want to set the fans on the front fan shelves to high speed, type:

```
fan -s fast
```

For information on the `fan(1M)` command, click the Help button. A help window is displayed (see “Help Window” on page 16). Or, refer to the `fan(1M)` man page.

Blacklist Administration

The blacklisting feature enables you to configure the following components out of the system:

- System boards
- Processors
- Address buses
- Data buses
- Data routers
- I/O controllers
- I/O adapter card
- System board memory
- Memory DIMM groups
- Sun Enterprise 10000 half-centerplane
- Port controller ASICs
- Data buffer ASICs
- Coherent interface controller ASICs
- 72-bit half of 144-bit, local, data router within system boards

Generally, you may want to blacklist a component if you believe that component is having intermittent problems, or if it is failing sometime after the system is booted.

If a component has a problem that shows up in the power-on self-test (POST) run by `hpost(1M)` (which is run by the `bringup(1M)` command), that component is automatically configured out of the system by `hpost(1M)`. However, that component is not blacklisted. `hpost(1M)` is run on the components in the system before a domain is booted, and on the components on a given board before that board is attached with Dynamic Reconfiguration (DR). See the *Sun Enterprise 10000 Dynamic Reconfiguration User's Guide*.

To blacklist a component, you can edit the `blacklist(4)` file with a text editor, or use Hostview. Hostview does not allow you to blacklist all possible components, so there may be times when you need to edit `blacklist(4)` directly. When a domain

runs POST, `hpost(1M)` reads the `blacklist(4)` file and automatically excludes the components specified in that file. Thus, changes that you make to the `blacklist(4)` file do not take effect until the domain is rebooted.

The file is `$$SSPVAR/etc/platform_name/blacklist`, where *platform_name* is the name of the platform. See the `blacklist(4)` man page for information about the contents of the `blacklist(4)` file.

▼ To Blacklist Components From Within Hostview

1. Choose Blacklist File from the Edit menu.

The Blacklist Edit window is displayed (FIGURE 7-1).

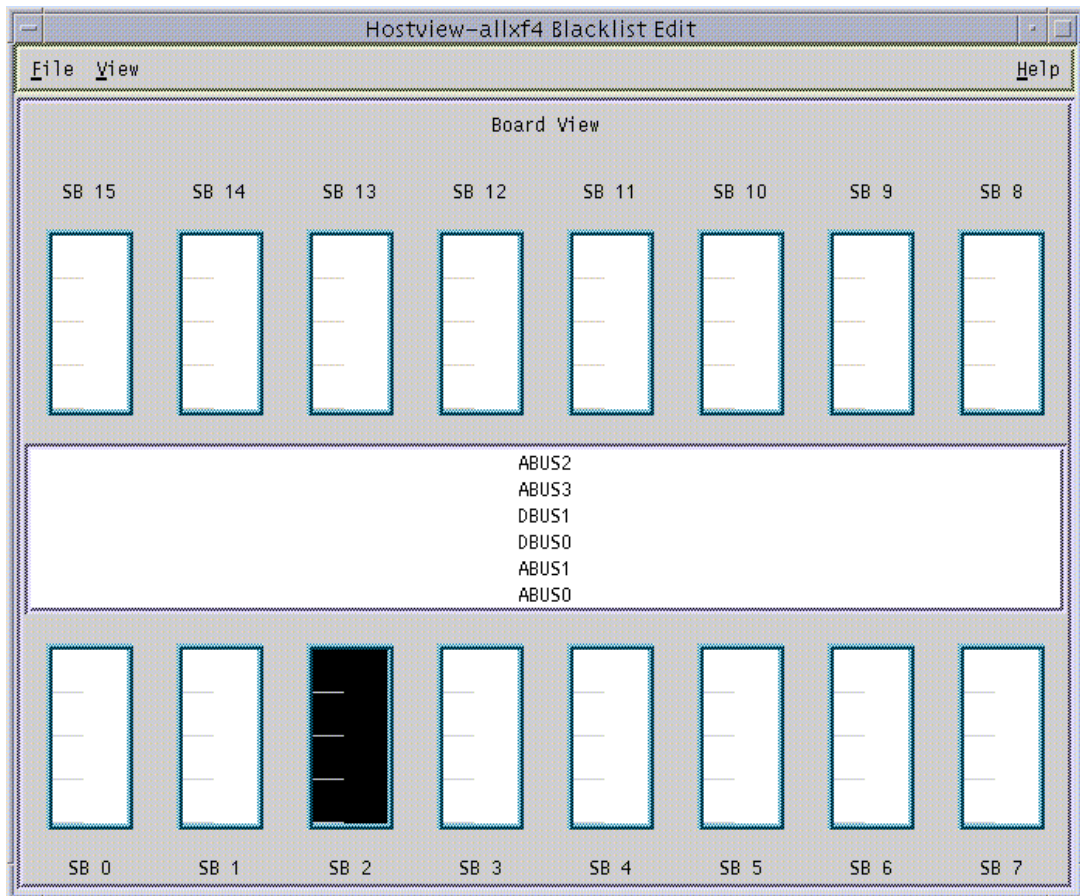

FIGURE 7-1 Blacklist Edit Window—Board View

2. Select the boards and/or buses that you want to place onto the blacklist.

To select a single component and deselect all other components of that type (for example, to select a single board and deselect all other boards), click on that component with the left mouse button. To toggle the selection status of a single component without affecting the selection status of any other component, click on that component with the middle mouse button. The selected components are displayed in black.

3. To save the changes, choose Save from the File menu.

4. To exit the Blacklist Edit window, choose Close from the File menu.

If you have unsaved changes and you close the Blacklist Edit window by choosing Close from the File menu, you are prompted to save the changes.

▼ To Blacklist Processors From Within Hostview

1. Choose Blacklist File from the Edit menu.

The Blacklist Edit window is displayed.

2. From the Blacklist Edit window, choose Processors from the View menu.

The Blacklist Edit window displays the Processor View window (FIGURE 7-2).

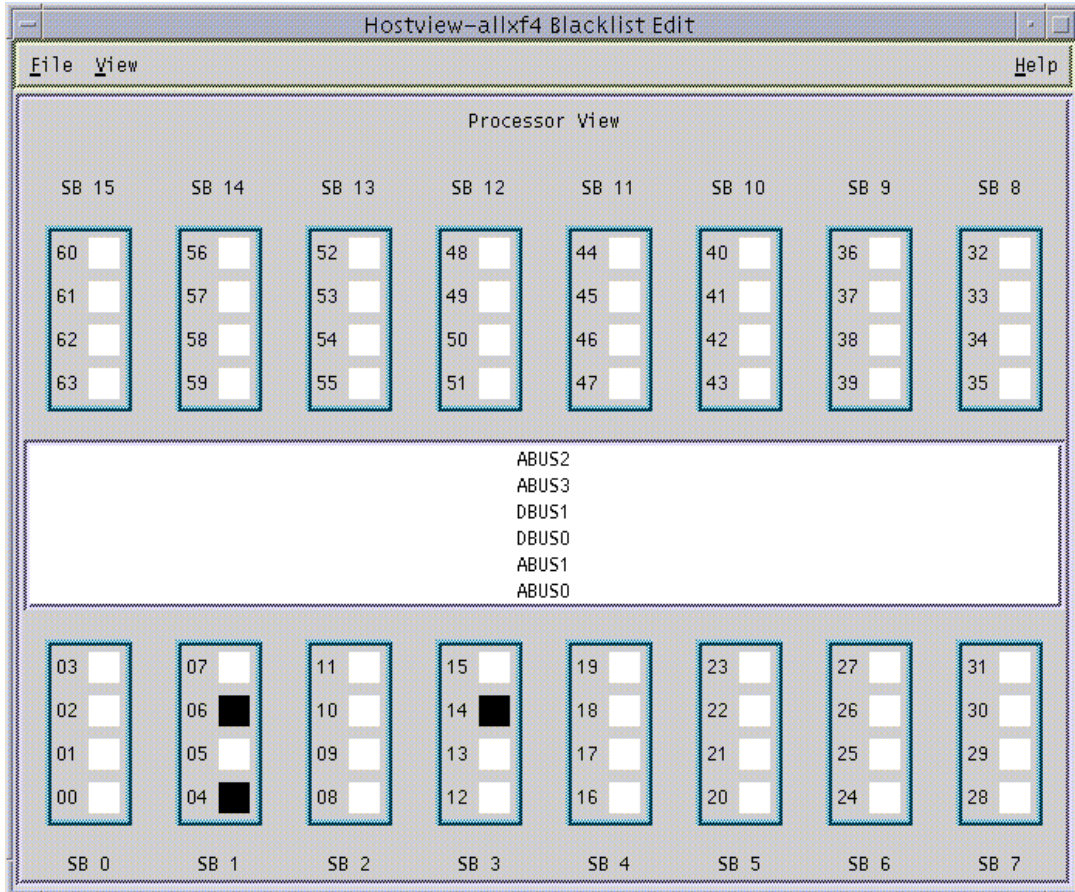

FIGURE 7-2 Blacklist Edit Window—Processor View

3. Select the processors that you want to add to the blacklist.

To select a single processor on a board and deselect all other processors on that board, click on that processor with the left mouse button. To toggle the selection status of a processor on a board without affecting the selection status of any other processors on that board, click on that processor with the middle mouse button. The selected processors are displayed in black.

4. To save the changes, choose Save from the File menu.

5. To exit the Blacklist Edit window, choose Close from the File menu.

If you have unsaved changes and you close the Blacklist Edit window by choosing Close from the File menu, you are prompted to save the changes.

▼ To Clear the Blacklist File From Within Hostview

1. In Hostview, choose **Blacklist File** from the **Edit** menu.
2. From the **Blacklist Edit** window, choose **New** from the **File** menu.
3. From the **Blacklist Edit** window, choose **Close** from the **File** menu.

Using a Spare SSP

The SSP is a Sun workstation or Sun server with a defined hardware configuration. You can use a Sparcstation 5, Sun Ultra 5, or Sun Enterprise 250 workstation or server as an SSP. You can also use one of these three systems as a spare SSP to serve as a backup if your main SSP fails. In addition, you can order a Sun Enterprise 10000 server with a spare SSP.

Maintain a spare SSP in a ready state. This allows you to quickly switch to the spare SSP if the main SSP fails. Do not run any third party software on the spare SSP. (If you are using clusters, you can run the Sun Cluster Console on the main SSP. Clustering is beyond the scope of this manual.)

To maintain a spare SSP, you must adhere to the following requirements:

- The spare SSP must be properly configured to function in the same way as the main SSP within the network.
- You must not install or use any third party software on the SSP.
- Any changes that you make to the main SSP must be made to the spare SSP as well. After any system configuration operation, you must *immediately* run `ssp_backup(1M)` on the main SSP. If the main SSP crashes, you will have a backup file that you can restore to the spare SSP by running `ssp_restore(1M)`. For more information about `ssp_backup(1M)` and `ssp_restore(1M)`, see “To Switch Between the Main and Spare SSP” on page 64 and the `ssp_backup(1M)` and `ssp_restore(1M)` man pages in the *Sun Enterprise 10000 SSP 3.2 Reference Manual*.

Note – You can run any combination of SSP versions 3.1, 3.1.1 and 3.2 on the main and spare SSP machines provided you are not using IDN. If you are using IDN, both the main and spare SSP must be running SSP 3.2.

▼ To Switch Between the Main and Spare SSP

1. Verify that the main SSP is correctly configured for switching to the spare SSP.

If the main SSP is running SSP 3.2 and the spare SSP is running SSP 3.1 or 3.1.1 and you are using IDN on the main SSP, you must do the following prior to switching to the spare SSP:

a. On the main SSP, unlink all IDN domains.

See `domain_unlink(1M)`.

b. On the domains, remove all `/etc/hostname.idnx` files, where *x* is an integer.

c. On each IDN domain, halt the domain and set the `idn-smr-size` environment variable to zero.

d. Reboot domains the domains you halted in Step c.

Refer to the *Sun Enterprise 10000 Inter-Domain Network User Guide*.

2. Change the main SSP to a spare SSP:

a. Log in to the main SSP as superuser.

b. Type:

```
ssp# /opt/SUNWssp/bin/ssp_backup backup_dir
```

This command backs up the SSP configuration information to the file `backup_dir/ssp_backup.cpio`.

c. Type:

```
ssp# /opt/SUNWssp/bin/ssp_config
Beginning setup of this workstation to act as a MAIN or SPARE SSP.
Are you currently configuring the MAIN SSP? (y/n)n
SPARE SSP configuration completed.
ssp#
```

3. Change the spare SSP to a main SSP:

a. Log in to the spare SSP as superuser.

b. Restore the `ssp_backup.cpio` file that you created in Step 2 by typing:

```
ssp# /opt/SUNWssp/bin/ssp_restore backup_dir/ssp_backup.cpio
```

where `backup_dir` is the directory in which the backup file is located.

Note – Do not change the SSP environment between the time you run `ssp_backup(1M)` and `ssp_restore(1M)`. For example, after you run `ssp_backup(1M)`, do not shut down a domain, bring up a domain, or power boards on or off until you run `ssp_restore(1M)`.

c. Change the spare SSP to be the main SSP by typing:

```
ssp# /opt/SUNWssp/bin/ssp_config spare
Configuring the spare SSP to control the Host

Beginning set up of the SPARE SSP workstation to control the host.

Platform name = allxf4
Control board 0 = xf4-cb0 => 129.153.151.123
Control board 1 = xf4-cb1 => 129.153.152.123
Primary Control Board = 0

Is this correct? (y/n)y

This SPARE SSP is NOW configured to control the host.

This machine is the MAIN SSP now.
```

Note – Verify that all SSP daemons have started before proceeding.

d. If this SSP is running the SSP 3.1 software, reboot the SSP.

4. For each domain on the host, perform the following steps.

If a domain is down when you perform this procedure, the console window may be unusable after the domain is brought up by the spare SSP. If the console is unusable, perform these steps using an `rlogin` or `telnet` session.

a. From the new main SSP, or from another workstation on the network, `rlogin` to the domain as superuser.

b. Edit the `/etc/ssphostname` file to replace the hostname of the main SSP with the hostname of the spare SSP.

For example, if your main SSP is called `xf4-ssp` and your spare SSP is called `xf4-ssp2`, change the contents of `/etc/ssphostname` to `xf4-ssp2`.

c. Switch console communication from the main SSP to the spare SSP:

```
# ps -ef | grep cvcd
# kill -9 cvcd_pid
# cvcd_path/cvcd
```

where `cvcd_path` is `/sbin` under the 2.6 operating environment, and `cvcd_path` is `/platform/SUNW,Ultra-Enterprise-10000/lib/cvcd` under the Solaris 7 operating environment.

d. If needed, update the `/etc/syslog.conf` file on each domain to replace the hostname of the main SSP with the hostname of the spare SSP.

Dual Control Board Handling

A platform can be configured with dual control boards for redundancy purposes. Although you can manually switch between the control boards, only one control board at a time is used by the system.

One of the control boards is identified as the primary control board. The SSP attempts to communicate only with the primary control board. If you decide that it is necessary to switch the primary control board because of a connection failure or for other reasons, you must modify the control board configuration file and reboot the SSP to activate the new primary control board. Note that this operation cannot be performed without rebooting all running domains because the control board provides the system clocks for all boards.

Control Board Executive

The control board executive (CBE) runs on the control board and facilitates communication between the SSP and the platform.

When power is applied, both control boards boot from the SSP that is serving as the boot server. After the CBE is booted, it waits for the control board server running on the SSP to establish a connection.

Primary Control Board

When the control board server running on the SSP connects to the CBE running on a control board, the CBE asserts the control board as the primary control board. The primary control board is responsible for providing the system clock and JTAG clock and for controlling fan trays and bulk power supplies.

Control Board Server

After the SSP is booted, the control board server (CBS), is started automatically. The CBS is responsible for all communication between the SSP and the primary control board.

The CBS attempts to connect only to the primary control board identified in the control board configuration file. The format of the file is as follows:

```
platform_name: platform_type: cb0_hostname: status0: cb1_hostname: status1
```

where:

platform_name is the name assigned by the system administrator.

platform_type is defaulted to Ultra-Enterprise-10000.

cb0_hostname is the host name for control board 0, if available.

status0 indicates that control board 0 is the primary control board (P indicates primary, and anything else indicates non-primary).

cb1_hostname is the host name for control board 1, if available.

status1 indicates that control board 1 is the primary control board.

For example:

```
xf2:Ultra-Enterprise-10000:xf2-cb0:P:xf2-cb1:
```

This example indicates that there are two control boards in the xf2 platform. They are xf2-cb0 and xf2-cb1. xf2-cb0 is specified as the primary. See the `cb_config(4)` man page for more information.

The communication port that is used for communication between the control board server and the control board executive is specified in `/tftpboot/xxxxxxx.cb_port`, where `xxxxxxx` is the control board IP address represented in hexadecimal format.

Control Board Executive Image and Port Specification Files

The SSP is the boot server for the control board. Two files are downloaded by the control board boot PROM during boot time: the image of CBE and the port number specification file. These files are located in /tftpboot on the SSP and the naming conventions are:

```
/tftpboot/xxxxxxx for the cbe image  
/tftpboot/xxxxxxx.cb_port for the port number
```

where xxxxxxx is the control board IP address in hex format.

For example, the files for control board xf2-cb0 are:

```
/tftpboot/81973213  
/tftpboot/81973213.cb_port
```

If you are using NIS, the IP address of xf2-cb0 can be determined as follows:

```
% ypcat hosts | grep xf2-cb0
```

The returning address is 129.153.49.147. This can be converted to 81993193.

▼ To Switch the Primary Control Board



Caution – Do *not* edit the /var/opt/SUNWssp/.ssp_private/cb_config file manually. Instead, use the ssp_config(1M) command as described below. Otherwise, your domains may fail and arbitration stops (arbstops) may occur.

1. **If any domains are running, shut down those domains using the standard shutdown(1M) command.**
2. **Log in to the main SSP as ssp.**
3. **Power off all of the system boards.**

```
ssp% power -off -all
```

4. Power on all of the system boards.

```
ssp% power -on -all
```

5. Log in to the main SSP as superuser.

6. Obtain the host names and IP addresses for the two control boards.

7. Verify that control board IP addresses are set up properly in the `/etc/inet/hosts` file or in your local name service system.

8. As superuser, type `ssp_config(1M)`:

In this sample session, the primary control board is switched from `snax-cb0` to `snax-cb1`.

```
ssp# /opt/SUNWssp/bin/ssp_config cb

Configuring control boards.

Platform name      = snax
Control Board 0 = snax-cb0 => 129.153.49.181
Control Board 1 = snax-cb1 => 129.153.49.182
Primary Control Board = 0

Is this correct? (y/n): n
Do you have a control board 0? (y/n): y
Please enter the host name of the control board 0 [snax-cb0]:
Do you have a control board 1? (y/n): y
Please enter the host name of the control board 1 [snax-cb0]:

Please identify the primary control board.
Is Control Board 0 [snax-cb0] the primary? (y/n) n
Is Control Board 1 [snax-cb1] the primary? (y/n) y

Platform name      = snax
Control Board 0 = snax-cb0 => 129.153.49.181
Control Board 1 = snax-cb1 => 129.153.49.182
Primary Control Board = 1

Is this correct? (y/n): y
```

Note – The platform name identifies the *entire host machine*, not a particular domain.

9. Restart the main SSP processes.

a. Log in as superuser and type:

```
ssp# /etc/init.d/ssp stop
ssp# /etc/init.d/ssp start
```

b. Log in to the SSP as user `ssp` and type:

```
ssp% tail -f $SSPLOGGER/messages
```

Wait until you see the following message:

```
Startup of SSP programs complete
```

10. Start Hostview:

```
ssp% hostview &
```

Verify that the “J” and “C” symbols are shown on the symbol for Control Board 1 in the main Hostview screen. This indicates that the JTAG connection and clock distribution signals are coming from Control Board 1.

If Hostview fails to respond, verify that you can communicate with Control Board 1. If you are unable to use `ping(1M)` to communicate with Control Board 1, visually examine the LEDs to verify that the control board is operating correctly. For example, verify that the link integrity LED is on. This indicates that the Ethernet connection is good. If the LEDs are cycling through a pattern, the control board is booted. If the LEDs are all off or all on continuously (without cycling through a pattern), the control board is not booted. Try running `snoop(1M)` on the SSP to verify that the control boards are communicating correctly.

11. If you have a spare SSP, repeat Step 6 through Step 8 above, on the spare SSP.

12. Issue the `bringup(1M)` command for all domains.

SSP Internals

SSP operations are generally performed by a set of daemons and commands. This chapter provides an overview of how the SSP works and describes the SSP 3.2 daemons, processes, commands, and system files. For more information about daemons, commands, and system files, refer to the *Sun Enterprise 10000 SSP 3.2 Reference Manual*.



Caution – Changes made to files in `/opt/SUNWssp` can cause serious damage to the system. Only very experienced system administrators should risk changing the files described in this chapter.

Startup Flow

The events that take place when the SSP boots are as follows:

1. User powers on the SSP (monitor, CPU/disk, and CD-ROM). The SSP boots automatically.
2. During the SSP boot process, the `/etc/rc2.d/s99ssp` startup script is called when the system enters run level 2. This script starts `ssp_startup`.
3. `ssp_startup` starts the SSP daemons: `machine_server`, `fad`, `cbs`, `straps`, `snmpd`, and `edd`. It also calls `cb_reset` to start control board initialization.
4. `edd` initiates event monitoring on the Sun Enterprise 10000 system control board, waits for an event to be generated by the event detection task running on the control board, and then responds to the event by running a response action script on the SSP.
5. After the SSP startup complete message is displayed, you can use SSP 3.2 commands such as `domain_create` or `bringup`.

The SSP uses the event detector daemon, `edd(1M)`, to monitor the Sun Enterprise 10000 system. Each time the SSP boots, it runs `/etc/rc2.d/S99ssp`, which in turn loads `edd(1M)` through the startup script, `$$SSP/ETC/ssp_startup.sh`. The startup script checks the environment for availability of certain files and the availability of the Sun Enterprise 10000 system, sets environment variables, and then starts `edd(1M)`. `edd(1M)` obtains many of its initial control parameters from the following configuration files:

- `$$SSPVAR/etc/platform_name/edd.erc` provides configuration information for the Sun Enterprise 10000 platform.
- `$$SSPVAR/etc/platform_name/domain_name/edd.erc` provides configuration information for a particular domain. The event response configuration files (`edd.erc`) specify how the event detector will respond to events.
- `$$SSPVAR/etc/platform_name/edd.emc` lists the events that `edd(1M)` will monitor.

If a domain crashes, `edd(1M)` invokes the `bringup(1M)` script. The `bringup(1M)` script runs the POST program, which tests Sun Enterprise 10000 components. It then uses the `obp_helper(1M)` daemon to download and begin execution of OBP in the domain specified by the `SUNW_HOSTNAME` environment variable. This happens only if a domain fails (for example, after a kernel panic) in which case it is rebooted automatically. After a halt or shutdown, you must manually run `bringup(1M)`, which then causes OBP to be downloaded and run.

`obp_helper(1M)` is responsible for loading `download_helper` in all the configured processors' bootbus SRAM. All the processors are started, with one processor designated as the boot processor. With the assistance of `download_helper`, `obp_helper(1M)` loads OBP into the memory of the Sun Enterprise 10000 system and starts OBP on the boot processor. See "OBP Daemon" on page 82 for more information about `obp_helper(1M)` and OBP.

The primary task of OBP is to boot and configure the operating system from either a mass storage device or from a network. OBP also provides extensive features for testing hardware and software interactively. As part of the boot procedure, OBP probes all the SBus slots on all the system boards and builds a device tree. This device tree is passed on to the operating system.

Sun Enterprise 10000 Client/Server Architecture

The Sun Enterprise 10000 system control board interface is accessed over an Ethernet connection using the TCP/IP protocol. The control board executive, CBE, runs on the control board. The control board server, `cbs(1M)`, runs on the SSP and makes service requests. The SSP control board server provides services to SSP clients.

FIGURE 10-1 illustrates the Sun Enterprise 10000 system client/server architecture:

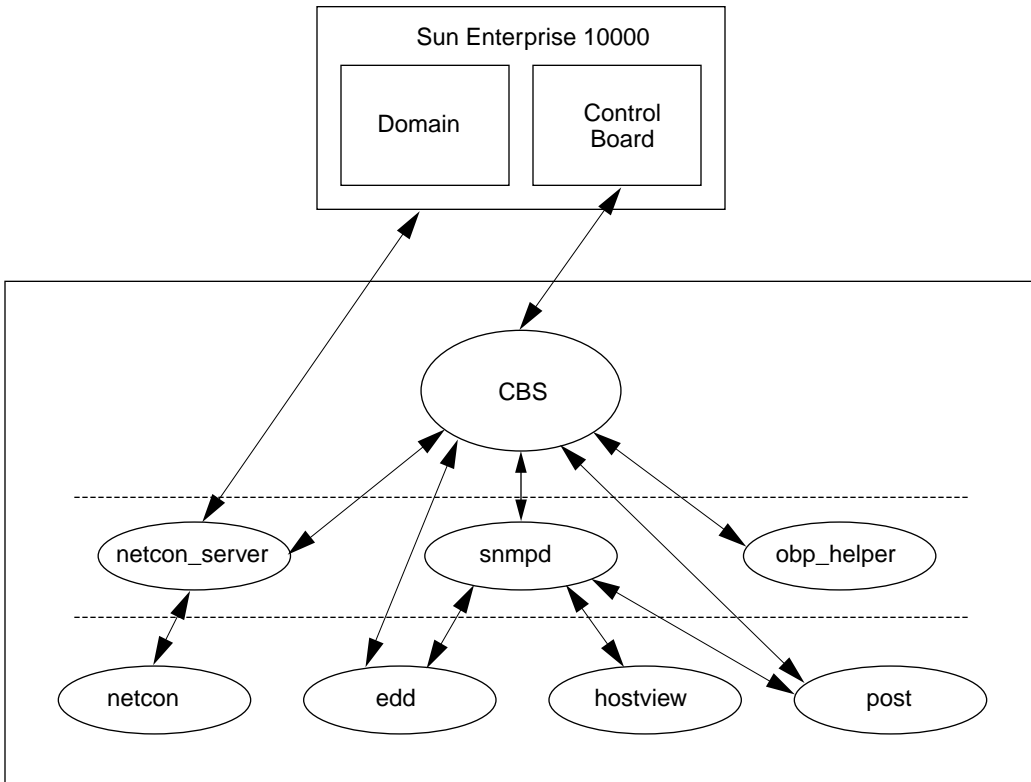

FIGURE 10-1 Sun Enterprise 10000 Client/Server Architecture

Note – There is one instance of `edd(1M)` for the platform supported by the SSP. There is one instance of `obp_helper(1M)` and `netcon_server(1M)` for each domain on the platform.

POST

Power-on self-test (POST) probes and tests the components of uninitialized Sun Enterprise 10000 system hardware, configures what it deems worthwhile into a coherent initialized system, and hands it off to OpenBoot PROM (OBP). POST passes to OBP a list of only those components that have been successfully tested; those in the `blacklist(4)` file are excluded.

`hpost(1M)` is the SSP-resident executable program that controls and sequences the operations of POST. `hpost(1M)` reads directives in the optional file `.postrc` (see `postrc(4)`) before it begins operation with the host.



Caution – Running `hpost(1M)` outside of the `bringup(1M)` command can cause the system to fail. `hpost(1M)`, when run by itself, does not check the state of the platform, and causes fatal resets.

POST looks at `blacklist(4)`, which is on the SSP, before preparing the system for booting. `blacklist(4)` specifies the Sun Enterprise 10000 components that POST must not configure.

POST stores the results of its tests in an internal data structure called a *board descriptor array*. The board descriptor array contains status information for most of the major components of the Sun Enterprise 10000 system, including information about the UltraSPARC™ modules.

POST attempts to connect and disconnect each system board, one at a time, to the system centerplane. POST then connects all the system boards that passed the tests to the system centerplane.

Daemons

The SSP 3.2 daemons play a central role on the SSP. Each daemon is fully described in its corresponding man page. The following table briefly describes the daemons.

TABLE 10-1 Daemons

Name	Description
<code>cbs</code>	The control board server provides central access to the Sun Enterprise 10000 control board for client programs running on the SSP.
<code>edd</code>	The event detector daemon initiates event monitoring on the control boards. When a monitoring task detects an event, <code>edd(1M)</code> runs a response action script.
<code>fad</code>	The file access daemon provides distributed file access services to SSP clients that need to monitor, read, and write to the SSP configuration files.
<code>machine_server</code>	Provides machine services for <code>netcon(1M)</code> and routes host messages to proper messages file. See <code>machine_server(1M)</code> .
<code>netcon_server</code>	The connection point for all <code>netcon(1M)</code> clients. <code>netcon_server(1M)</code> communicates with OBP using a control board protocol. <code>netcon_server(1M)</code> communicates with the OS using the TCP protocol.
<code>obp_helper</code>	Runs OpenBoot. <code>obp_helper(1M)</code> terminates when OBP is terminated. During execution, <code>obp_helper(1M)</code> provides services to OBP, such as NVRAM simulation, IDPROM simulation, and time of day.
<code>snmpd</code>	The SNMP proxy agent listens to a UDP port for incoming requests and services the group of objects specified in <code>Ultra-Enterprise-10000.mib</code> .
<code>straps</code>	The SNMP trap sink server listens to the SNMP trap port for incoming trap messages and forwards received messages to all connected clients.
<code>xntpd / ntpd</code>	The network time protocol (NTP) daemon provides time synchronization services. (<code>ntpd</code> is the daemon for the Solaris 2.6 and Solaris 7 operating environments.) Clients can connect to this service and have their clocks automatically adjusted. This service is used to synchronize SSP and domain times. See <code>xntpd(1M)</code> and the <i>Network Time Protocol User's Guide</i> .

Event Detector Daemon

The event detector daemon, `edd(1M)`, is a key component in providing the reliability, availability, and serviceability (RAS) features of Sun Enterprise 10000 system. `edd(1M)` initiates event monitoring on the Sun Enterprise 10000 control board, waits for an event to be generated by the event detection monitoring task running on the control board, and then responds to the event by executing a response action script on the SSP. The conditions that generate events and the response taken to events are fully configurable.

`edd(1M)` provides the mechanism for event management, but does not handle the event detection monitoring directly. Event detection is handled by an event monitoring task that runs on the control board. `edd(1M)` configures the event monitoring task by downloading a vector that specifies the event types to be monitored. Event handling is provided by response action scripts, which are invoked on the SSP by `edd(1M)` when an event is received.

The RAS features are provided by several collaborative programs. The control board within the platform runs a control board executive (CBE) program that communicates through the Ethernet with a control board server (`cbs(1M)`) program on the SSP. These two components provide the data link between the platform and the SSP.

The SSP provides a set of interfaces for accessing the control board through the control board server and the simple network management protocol (SNMP) agent. `edd(1M)` uses the control board server interface to configure the event detection monitoring task on the control board executive (FIGURE 10-2).

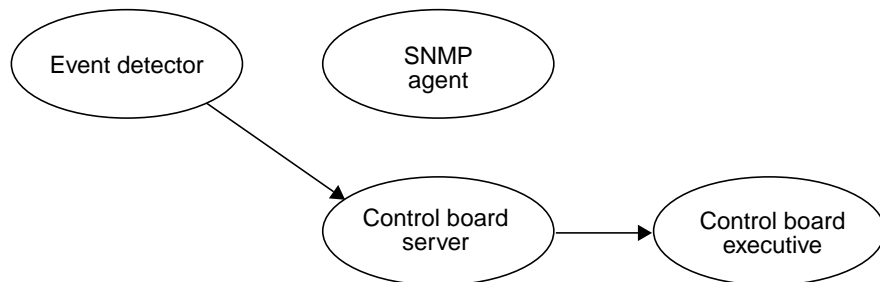

FIGURE 10-2 Uploading Event Detection Scripts

After it is configured, the event detection monitoring task polls various conditions within the platform, including environmental conditions, signature blocks, power supply voltages, performance data, and so forth. If an event detection script detects a change of state that warrants an event, an event message containing the pertinent information is generated and delivered to the control board server (`cbs(1M)`)

running on the SSP. Upon receipt of the event message, the control board server delivers the event to the SNMP Agent, which in turn generates an SNMP trap (FIGURE 10-3).

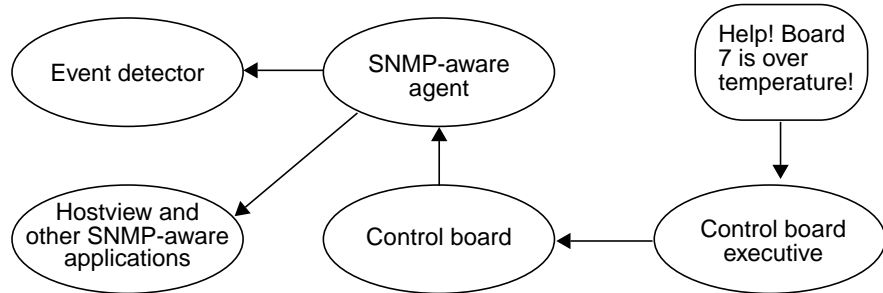

FIGURE 10-3 Event Recognition and Delivery

Upon receipt of an SNMP trap, `edd(1M)` determines whether to initiate a response action. If a response action is required, `edd(1M)` runs the appropriate response action script as a subprocess (FIGURE 10-4).

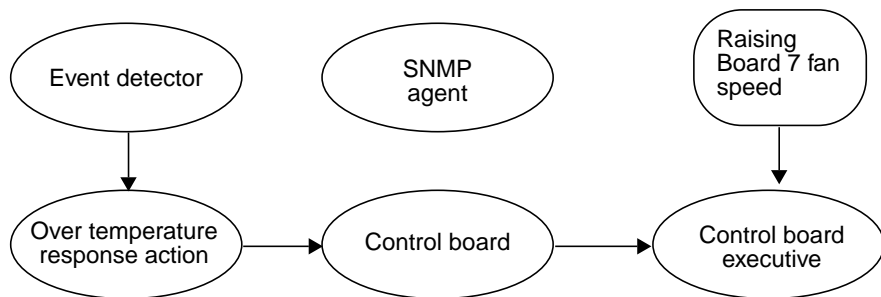

FIGURE 10-4 Response Action

Event messages of the same type or related types can be generated while the response action script is running. Some of these secondary event messages may be meaningless or unnecessary if a responsive action script is already running for a similar event; for example, if `edd(1M)` is running a response action script for a high-temperature event. While the response action script is running, additional high temperature events can be generated by the event monitoring scripts. `edd(1M)` does not respond to those high temperature events (generated in response to the same

high temperature condition) until the first response script has finished. It is the responsibility of applications (such as `edd(1M)`) to filter the events they will respond to as necessary. The cycle of event processing is completed at this point.

Control Board Server

The control board server (CBS) runs on the SSP. Whenever a client program running on the SSP needs to access the Sun Enterprise 10000 system, the communication is funneled through `cbs(1M)`. `cbs(1M)`, in turn, communicates directly with a control board Executive (CBE) running on one of the control boards in the Sun Enterprise 10000 system. `cbs(1M)` converts client requests to the control board management protocol (CBMP) that is understood by CBE. The following diagram (FIGURE 10-5) shows how the CBS and CBEs are connected.

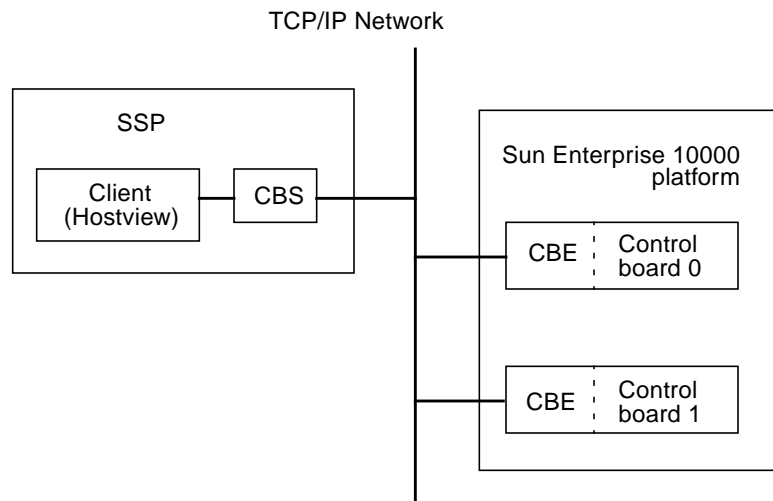

FIGURE 10-5 CBS Communication Between SSP and Sun Enterprise 10000 System

`cbs(1M)` relies on the `cb_config(4)` file to determine the platform it is to manage, and the control board with which it is to interact. The `cb_config(4)` file specifies the platforms managed by the SSP. Do not directly modify this file; it is automatically maintained by domain management tools and commands. To make a control board change, use `ssp_config(1M)` with the `cb` option.

File Access Daemon

The file access daemon (`fad(1M)`) is used when `ssp_to_domain_hosts(4)` or any other configuration file is updated. `fad(1M)` provides distributed file access services, such as file locking, to all SSP clients that need to monitor, read, and write changes to SSP configuration files. Once a file is locked by a client, other clients are prevented from locking that file until the first client releases the lock.

Network Time Protocol Daemon

The NTP daemon (`ntpd(1M)` for the Solaris 2.6 and Solaris 7 operating environments) provides a mechanism for keeping the time settings synchronized between the SSP and the domains. OBP obtains the time from the SSP when the domain is booted, and NTP keeps the time synchronized from that point on.

The configuration is based on information provided by the system administrator. If the Sun Enterprise 10000 system is not currently running in an NTP subnet, does not have access to the Internet, and is not going to use a radio clock, you can set up the Sun Enterprise 10000 system to use its own internal time-of-day clock as the reference clock. Usually, however, the SSP uses its internal time-of-day clock for the Sun Enterprise 10000 system.

The NTP packages are compiled with support for a local reference clock. This means that your system can poll itself for the time instead of polling another system or network clock. The poll is done through the network loopback interface. The first three numbers in the IP address are 127.127.1. The last numbers in the IP address are the NTP stratum to use for the clock.

When setting up domains on an Sun Sun Enterprise 10000 system and its SSP, set the SSP to stratum 4. Set up the domains as a peer to the SSP and set the local clock at least one stratum higher than the SSP.

An example of server/peer lines in the `/etc/opt/SUNWxntp/ntp.conf` file on the SSP is shown below.

```
server 127.127.1.4
```

You can add the following example lines to the `/etc/inet/ntp.conf` file on the domains:

```
server ssp_name  
server 127.127.1.13 stratum 13
```

For more information on the NTP daemon, refer to the *Network Time Protocol User's Guide* and the *NTP Reference Manual*.

OBP Daemon

On the SSP, OpenBoot (OBP) is not a hardware PROM; it is loaded from a file on the SSP. An SSP file also replaces the traditional OBP NVRAM and `idprom (hostid)`.

The OBP file is located under a directory path that is specific to the SunOS release. (Note that SunOS 5.6 corresponds to the Solaris 2.6 operating environment and SunOS 5.7 corresponds to the Solaris 7 operating environment. You can determine your SunOS version with `uname -r`.) For example, under SunOS 5.7, the OBP file is located in the following directory:

```
/opt/SUNWssp/release/Ultra-Enterprise-10000/5/7/hostobjs/obp
```

where the `/5/7` portion of the path corresponds to the SunOS version number. If your release contains a different version of the operating system, that portion of the path will be different.

`bringup(1M)` starts `obp_helper(1M)` in the background, which kills the previous `obp_helper(1M)`, if one exists. `obp_helper(1M)` runs `download_helper` and subsequently downloads and runs OBP.

`obp_helper(1M)` is essential in starting processors other than the boot processor. It communicates with OBP through bootbus SRAM (BBSRAM), responding to requests to supply the time-of-day, get or put the contents of the pseudo-EEPROM, and release slave processors when in multiprocessor mode. To release the slave processors, `obp_helper(1M)` must load `download_helper` into the BBSRAM of all the slave processors, place an indication in BBSRAM that it is a slave processor, then start the processor by releasing the bootbus controller reset.

For more information, see the `obp_helper(1M)`, and `bringup(1M)` man pages and “`download_helper` File” on page 84.

Environment Variables

Most of the necessary environment variables are set when the `ssp` user logs in. TABLE 10-2 describes the environment variables.

TABLE 10-2 Environment Variables

<code>SUNW_HOSTNAME</code>	The name of the domain controlled by the SSP.
<code>SSPETC</code>	The path to the directory containing miscellaneous SSP-related files.
<code>SSPLOGGER</code>	The location of the configuration file for message logging. You should never change the value of this environment variable.
<code>SSPOPT</code>	The path to the SSP package binaries, libraries, and object files.
<code>SSPVAR</code>	The path to the directory where modifiable files reside.

Executable Files Within a Domain

Executable files that are run within a domain reside in the `/opt/SUNWssp/release/Ultra-Enterprise-10000/os_version` directory. The man pages for these programs reside within the domain.

Some of the commands listed in this section must be used or modified only by your service provider; they are normally called internally by other programs rather than run on the command line.



Caution – Improper use of these commands can result in failure or damage to the system. If you are not sure of the function of any command, contact your service provider for assistance.

*.elf Files

These are executable files that are downloaded by `hpost(1M)`.

download_helper File

`download_helper` enables programs to be downloaded to the memory used by a domain instead of BBSRAM. This provides an environment in which host programs can run without having to know how to relocate themselves to memory. These programs can be larger than BBSRAM.

`download_helper` works by running a protocol through a mailbox in BBSRAM. The protocol has commands for allocating and mapping physical to virtual memory, and for moving data between a buffer in BBSRAM and virtual memory. When complete, the thread of execution is usually passed to the new program at an entry point provided by the SSP. After this occurs, `download_helper` lives on in BBSRAM so it can provide reset handling services. Normally, you do not need to be concerned with the download helper; it is used only by the `obp_helper(1M)` daemon. See the `obp_helper(1M)` man page for more information.

obp File

The `obp` file is fundamental to the boot process of a domain. OBP knows how to probe the SBus to determine which devices are connected where, and provides this information to the operating system in the form of a device tree. The device tree is ultimately visible using the command `prtconf` (for more information, see the SunOS `prtconf(1M)` man page).

`obp` also interprets and runs FCode on SBus cards, which provides loadable, simple drivers for accomplishing boot. In addition, it provides a kernel debugger, which is always loaded.

Glossary

Alternate Pathing

(AP) AP enables you to set up an alternate path to system components in case of failure, repair, or replacement.

AP See *Alternate Pathing (AP)*.

**application specific
integrated circuit**

(ASIC) In the Sun Enterprise 10000 system, any of the large main chips in the design, including the UltraSPARC processor and data buffer chips.

arbitration stop

A condition that occurs when one of the Sun Enterprise 10000 system ASICs detects a parity error or equivalent fatal system error. Bus arbitration is frozen, so all bus activity stops. The system is down until the SSP detects the condition by polling the Control and Status Registers CSRs of the Address Arbiter ASICs through JTAG, and clears the error condition.

ASIC See *application specific integrated circuit (ASIC)*.

BBSRAM See *bootbus SRAM (BBSRAM)*.

blacklist

A text file that `hpost(1M)` reads when it starts up. The blacklist file specifies the Sun Enterprise 10000 system components that are not to be used or configured into the system. The default path name for this file can be overridden in the `.postrc` file (see `postrc(4)`) and on the command line.

board descriptor

array

The description of the single configuration that `hpost(1M)` chooses. It is part of the structure handed off to `OBE`.

bootbus

A slow-speed, byte-wide bus controlled by the processor port controller ASICs, used for running diagnostics and boot code. UltraSPARC starts running code from bootbus when it exits reset. In the Sun Enterprise 10000 system, the only component on the bootbus is the BBSRAM.

**bootbus SRAM
(BBSRAM)**

A 256-Kbyte static RAM attached to each processor PC ASIC. Through the PC, it can be accessed for reading and writing from JTAG or the processor. Bootbus SRAM is downloaded at various times with `hpost(1M)` and OBP startup code, and provides shared data between the downloaded code and the SSP.

**control and status
register (CSR)**

A general term for any embedded register in any of the ASICs in the Sun Enterprise 10000 system.

CSR See *control and status register (CSR)*.

DIMM See *dual in-line memory module (DIMM)*.

domain A set of one or more system boards that acts as a separate system capable of booting the OS and running independently of any other domains.

DRAM See *dynamic RAM (DRAM)*.

**dual in-line memory
module (DIMM)**

A small printed circuit card containing memory chips and some support logic.

**dynamic RAM
(DRAM)**

Hardware memory chips that require periodic rewriting to retain their contents. This process is called "refresh". In the Sun Enterprise 10000 system, DRAM is used only on main memory SIMMs and on the control boards.

Ecache See *external cache (Ecache)*.

**external cache
(Ecache)**

A 0.5-Mbyte to 4-Mbyte synchronous static RAM second-level cache local to each processor module. Used for both code and data. This is a direct-mapped cache.

JTAG A serial scan interface specified by IEEE standard 1149.1. The name comes from Joint Test Action Group, which initially designed it. See JTAG+.

JTAG+ An extension of JTAG, developed by Sun Microsystems Inc., which adds a control line to signal that board and ring addresses are being shifted on the serial data line. Often referred to simply as JTAG.

OBP See *OpenBoot PROM (OBP)*.

**OpenBoot PROM
(OBP)**

A layer of software that takes control of the configured Sun Enterprise 10000 system from `hpost(1M)`, builds some data structures in memory, and boots the operating system.

POST See *power-on self-test*.

- power-on self-test (POST)** A test performed by `hpost(1M)`. This is the program that takes uninitialized Sun Enterprise 10000 system hardware and probes and tests its components, configures what seems worthwhile into a coherent initialized system, and hands it off to OBP.
- `.postrc` A text file that controls options in `hpost(1M)`. Some of the functions can also be controlled from the command line. Arguments on the command line take precedence over lines in the `.postrc` file, which takes precedence over built-in defaults. `hpost -? postrc` gives a terse reminder of the `.postrc` options and syntax. See `postrc(4)`.
- SBus** A Sun Microsystems Inc. designed I/O bus, now an open standard.
- SRAM** See *static RAM (SRAM)*.
- static RAM (SRAM)** Memory chips that retain their contents as long as power is maintained.
- SSP** See *System Service Processor (SSP)*.
- System Service Processor (SSP)** A workstation or server containing software for controlling power sequencing, diagnostics, and booting of a Sun Enterprise 10000 system.
- UltraSPARC** The UltraSPARC processor is the processor module used in the Sun Enterprise 10000 system.

Index

A

arbitration stop, 85
ASIC, 85

B

backing up the SSP, 63
BBSRAM, 86
blacklist, 85

- blacklisting components, 57
- blacklisting processors, 59
- clear blacklist file, 61
- editing in Hostview, 58

board descriptor array, 85
bootbus, 85
bringup, 32, 82

- example, 33

C

CBE (control board executive), 3, 67
CBS (control board server), 68, 80
CBS and CBE

- communications port, 68

clear blacklist file, 61
commands

- bringup, 82
- domain_create, 26
- domain_remove, 30
- domain_rename, 32
- domain_switch, 27, 32
- download_helper, 84

hostview, 10
netcon, 36
netcontool, 38
obp, 84
power, 47
ssp_backup, 63
ssp_restore, 63
sys_id, 27
communications port

- CBS and CBE, 68

components

- blacklisting, 57

Configuration menu

- Hostview, 14

configuring

- control boards, 69
- netcontool, 40

control and status register, 86
control board

- configuration, 69
- primary, 67

control board executive (CBE), 3, 67
control board server (CBS), 68, 80
control boards, 3
Control menu

- Hostview, 14

controlling fans

- Hostview, 55

creating domains

- using the command line, 26
- with Hostview, 24

D

- daemons
 - edd, 78
 - obp_helper, 77
 - SSP, 77
 - xntpd, 77
- DIMM, 86
- display
 - netcon window, 36
 - netcontool window, 38
- domain status
 - with Hostview, 33
- domain_create, 26
- domain_remove, 30
 - example, 30
- domain_rename, 32
- domains, 1
 - bringing up, 32
 - bringing up with Hostview, 32
 - creating, 24, 26
 - domain name, 25
 - removing, 30
 - renaming, 30
 - status, 33
- download_helper command, 84
- DRAM, 86
- dual control boards, 3
- Dynamic System Domains, 1

E

- edd daemon, 78
- Edit menu
 - Hostview, 14
- elf files, 83
- environment variables, 83
 - SSPETC, 83
 - SSPLOGGER, 83
 - SSPOPT, 83
 - SSPVAR, 83
 - SUNW_HOSTNAME, 83
- error message file, 21
- event detector daemon (edd), 78
- exclusive session permission
 - netcon, 35
- external cache, 86

F

- failure button
 - Hostview, 19
- fan button
 - Hostview, 18
- Fan Status Display window, 53
- fan tray window, 55
 - Hostview, 55
- fans
 - controlling in Hostview, 55
 - controlling speed, 56
 - monitoring in Hostview, 53

File menu

- Hostview, 14

files

- error messages, 21

H

Help

- Hostview, 16

Hostview

- blacklisting components, 58
- blacklisting processors, 59
- bringing up a domain, 32
- buttons, 18
- clear blacklist file, 61
- Configuration menu, 14
- Control menu, 14
- controlling fans, 55
- creating domains, 24
- displaying netcontool window, 39
- domain status, 33
- Edit menu, 14
- failure button, 19
- fan button, 18
- Fan Status Display window, 53
- File menu, 14
- Help, 16
- icons, 19
- main window, 11
- menu bar, 14
- monitoring fans, 53
- monitoring power levels, 47
- monitoring temperature, 51
- performance considerations, 20
- power button, 18
- powering components on or off, 45

- processor colors, 20
- processor symbols, 19
- renaming domains, 30
- selected system board, 12
- selecting items in main window, 13
- SSP Logs window, 21
- starting Hostview, 9
- swap space, 20
- temperature button, 18
- Terminal menu, 15
- Thermal Detail window, 52
- unselected system board, 12
- View menu, 16
- viewing messages file, 21

I

- icons
 - Hostview, 19

J

- JTAG, 86

L

- locked write permission
 - netcon, 35
- log file, 14, 21
- logging
 - disabling for netcon, 43
 - enabling for netcon, 43

M

- menu bar
 - Hostview, 14
- messages file
 - viewing, 21
- monitoring
 - fans, 53
 - temperature, 51

N

- netcon, 6, 35
 - communication paths for console I/O, 42
 - disabling logging, 43
 - displaying window, 36
 - enabling logging, 43
 - exclusive session, 42
 - exclusive sessions permission, 35
 - locked write, 42
 - locked write permission, 35
 - read only session, 41
 - unlocked write, 41
 - unlocked write permission, 35
- netcontool
 - buttons, 37
 - configuration window, 40
 - displaying from Hostview, 39
 - displaying window, 38
- network console window, 6

O

- OBP, 86
- obp command, 84
- OBP See OpenBoot PROM
- obp_helper daemon, 77
- OpenBoot PROM, 74, 82, 86

P

- performance considerations
 - Hostview, 20
- POST, 76, 87
- postrc, 87
- power
 - monitoring power levels in Hostview, 47
 - power command, 47
 - Power Status Display window, 48
 - powering components on or off, 47
 - powering on or off in Hostview, 45
- power button
 - Hostview, 18
- power-on self-test (POST), 87
- primary control board, 67
- processor colors
 - Hostview, 20
- processor symbols

- Hostview, 19
- processors
 - blacklisting, 59

R

- removing domains
 - using the command line, 30
- renaming domains
 - with Hostview, 30

S

- SBus, 87
- snmp agent, 78
- Solaris
 - version supported, 1
- spare SSP, 63
 - requirements, 63
 - switching to, 64
- speed of fans
 - controlling, 56
- SRAM, 87
- SSP
 - console window, 5
 - daemons, 77
 - features, 2
 - log, 14
 - requirements, 1
 - spare, 63
 - startup flow, 73
 - switching to spare SSP, 64
 - user environment, 3
 - window, 4
- SSP Logs window, 21
- ssp_backup, 63
- ssp_restore, 63
- SSPETC, 83
- SSPLOGGER, 83
- SSPOPT, 83
- SSPVAR, 83
- SUNW_HOSTNAME, 83
- swap space
 - Hostview, 20
- switching
 - control boards, 69
 - to spare SSP, 64

- System Service Processor, 1
- System Service Processor (SSP)
 - requirements, 1

T

- temperature
 - monitoring in Hostview, 51
- temperature button
 - Hostview, 18
- Terminal menu
 - Hostview, 15
- Thermal Detail window, 52

U

- unlocked write permission
 - netcon, 35
- user environment
 - SSP, 3

V

- View menu
 - Hostview, 16

W

- windows
 - Fan Status Display window, 53
 - fan tray, 55
 - Hostview main window, 11
 - netcon, 6, 36
 - netcontool, 38, 40
 - network console window, 6
 - Power Status Display, 48
 - SSP console window, 5
 - SSP Logs window, 21
 - SSP Window, 4
 - Thermal Detail window, 52

X

- xntpd daemon, 77